

PRINTRONIX®

LG

Programmer's Reference Manual

Line Matrix Series Printers

Trademark Acknowledgements

ANSI is a registered trademark of American National Standards Institute, Inc.

Code V is a trademark of Quality Micro Systems.

Chatillon is a trademark of John Chatillon & Sons, Inc.

Ethernet is a trademark of Xerox Corporation.

IBM is a registered trademark of International Business Machines Corporation.

IGP is a registered trademark of Printronix, LLC.

Intelligent Printer Data Stream and IPDS are trademarks of International Business Machines Corporation.

LinePrinter Plus is a registered trademark of Printronix, LLC.

MS-DOS is a registered trademark of Microsoft Corporation.

PC-DOS is a trademark of International Business Machines Corporation.

PGL is a registered trademark of Printronix, LLC.

PrintNet is a registered trademark of Printronix, LLC.

Printronix is a registered trademark of Printronix, LLC.

PSA is a trademark of Printronix, LLC.

QMS is a registered trademark of Quality Micro Systems.

RibbonMinder is a trademark of Printronix, LLC.

Torx is a registered trademark of Camcar/Textron Inc.

Utica is a registered trademark of Cooper Power Tools.

Printronix, LLC. makes no representations or warranties of any kind regarding this material, including, but not limited to, implied warranties of merchantability and fitness for a particular purpose. Printronix, LLC. shall not be held responsible for errors contained herein or any omissions from this material or for any damages, whether direct, indirect, incidental or consequential, in connection with the furnishing, distribution, performance or use of this material. The information in this manual is subject to change without notice.

This document contains proprietary information protected by copyright. No part of this document may be reproduced, copied, translated or incorporated in any other material in any form or by any means, whether manual, graphic, electronic, mechanical or otherwise, without the prior written consent of Printronix, LLC.

COPYRIGHT 2000, 2012, PRINTRONIX, LLC.

All rights reserved.

Table of Contents

1	Introduction	9
	About This Manual	9
	How to Use This Manual	9
	The DEC LG Emulation Line Matrix Printer	10
	Printer Features	10
	Printer Emulations	10
	Text Formatting and Language Options	10
	Bar Code Formatting	11
	Diagnostics	11
	Printing Speed	11
2	LG Emulation Control Codes	13
	LG Emulation	13
	Bar Code Printing	13
	Print Mode and Plot Mode	13
	Optimizing Print Mode	14
	Optimizing Plot Mode	14
	Character Printing	14
	DEC Multinational Character Set	15
	Selecting Graphic Character Sets	16
	Control Code Types	17
	Special Parsing Requirements	24
	Control Code Description Format	25
	Control Code Index	25
	Set/Reset Mode	29
	Line Feed/New Line Mode (LNM)	30
	Carriage Return/New Line Mode (DECCRNLM)	31
	Autowrap Mode (DECAWM)	31
	Pitch Select Mode (DECPSM)	31
	Set Page Orientation (DECSP0)	32
	Position Unit Mode (PUM)	32
	Force Plot Mode (DECFFPM)	33
	Select Size Unit (SSU)	34
	Graphic Size Selection (GSS)	34
	Graphic Size Modification (GSM)	35
	Setting Plot Density	35
	Set Graphics Density (DECSSGD)	35
	Spacing	37
	Spacing Pitch Increment (SPI)	38
	Select Vertical (Line) Spacing (SVS)	39

Set Vertical Pitch (DECVERP)	39
Select Horizontal (Character) Spacing (SHS)	40
Set Horizontal Pitch (DECSHORP)	40
Vertical Format	41
Load Vertical Format Unit (VFU)	42
End Load (VFU).....	42
Channel Command.....	43
Forms.....	44
Loading Forms Sequence (DECLFM)	44
Form Types	46
Start Forms Sequence (DECIFM)	47
Terminate Forms Sequence (DECTFM)	47
Delete Forms Sequence (DECDFM).....	48
Forms Considerations	48
Request Forms Status (DECFMSR)	49
Form Status Report (DECRFMS).....	49
Logos	49
Loading Logos Sequence (DECLLG).....	49
Select Logo Sequence (DECILG)	50
Deleting Logos Sequence (DECDLG).....	51
Request Logo Status (DECRLGS).....	51
Logo Status Report (DECLGSR).....	51
Page Print Area and Margins	52
Changing the Print Area	53
Page Format Select (PFS)	54
Set Lines Per Physical Page (DECCLPP).....	58
Set Top and Bottom Margins (DECSTBM).....	58
Set Left and Right Margins (DECSLRM).....	59
Active Column and Active Line (Cursor Motion)	60
Forward Index (IND).....	60
Reverse Index (RI)	60
Next Line (NEL)	61
Horizontal Position Absolute (HPA).....	61
Horizontal Position Relative (HPR)	61
Horizontal Position Backward (HPB).....	61
Vertical Position Absolute (VPA)	62
Vertical Position Relative (VPR).....	62
Vertical Position Backward (VPB)	62
Cursor Up (CUU).....	62
Partial Line Up (PLU) - Superscripting	63
Partial Line Down (PLD) - Subscripting.....	63
Tab Stops	63
Set Horizontal Tab Stops (DECSHTS).....	63

Horizontal Tab Stops (HTS)	64
Set Vertical Tab Stops (DECSVTS)	64
Vertical Tab Stops (VTS).....	65
Tab Clear (TBC)	65
Character Set Selection.....	66
Select Character Set Sequences (SCS)	67
Assign User Preference Supplemental Set (DECAUPSS).....	68
Product Identification (DA)	69
Printer Status Requests and Reports.....	69
Device Status Requests (DSRs) and Printer Responses	70
Assigning and Selecting Font Files	72
Assign Type Family or Font (DECATFF).....	73
Selecting Fonts for Printing (SGR)	74
Deleting Fonts from RAM (DECLFF).....	75
Font Status Sequences	75
Request Font Status (DECRFS)	75
Font Status Report (DECFSR)	76
Character Attributes (SGR)	76
Character Expansion (GSM)	77
Bold Printing	78
Crossed-Out Text	79
Double Underlined Text.....	79
Italic Printing	80
Overlined	80
Turn Off All Attributes	80
Underlined Text	81
Justification (JFY).....	81
Sixel Graphics Processing	82
Character Processing in Sixel Graphics Mode.....	85
Drawing Vectors (DECVEC).....	91
Block Characters	91
Setting Block Character Parameters (DECBCS)	92
Start Block Character Mode (DECBLOCKC)	93
Stop Block Character Mode	94
Reset to Initial State (RIS).....	94
Soft Terminal Reset (DECSTR)	94
Selecting LinePrinter Plus Emulations via DECIPEM	94
Selecting LinePrinter Plus Emulations via SOCS	95
7-Bit and 8-Bit Transmissions and Interpretations	96
Enter Draft Mode	96
Exit Draft Mode	96
Default Values and States.....	97

3	Character Sets	101
	Introduction.....	101
	Selecting the Character Set and Language.....	101
	OCR-A and OCR-B.....	101
	ASCII Character Set.....	101
	DEC Multinational Character Sets.....	105
	Additional ISO and Special Character Sets.....	110
4	Bar Codes	151
	Bar Codes.....	151
	Select Bar Codes Attributes Sequence (DECSBCA).....	151
	Start Bar Coding (DECBARC).....	153
	Stop Bar Coding (Return from Other Coding System: ROCS).....	153
	Bar Code Characteristics.....	154
	Number of Bars per Character.....	154
	START, STOP, and CENTER Code Characters.....	154
	Quiet Zone.....	155
	Intercharacter Gap.....	155
	Number of Characters in a Bar Code.....	155
	Checksums.....	155
	Parity.....	155
	Multiple Bar Codes.....	155
	Bar Code Styles.....	156
	Code 39.....	156
	Extended Code 39.....	156
	Code 11.....	158
	Codabar a/t.....	158
	Codabar b/n.....	158
	Codabar c/*.....	159
	Codabar d/e.....	159
	EAN-8.....	159
	EAN-13.....	160
	Interleaved 2 of 5.....	160
	UPC-A.....	161
	UPC-E.....	161
	Postnet.....	163
	Code 128 - USS.....	164
	Code 128 - UCC.....	170
	Density and Spacing Between Bar Codes.....	171
A	LG Emulation Character Sets	173
	Introduction.....	173
	LG Emulation Character Set Charts.....	173

U.S. ASCII.....	178
DEC Finnish.....	179
French.....	180
DEC French Canadian.....	181
German.....	182
Italian.....	183
JIS Roman.....	184
DEC Norwegian/Danish.....	185
Spanish.....	186
DEC Swedish.....	187
DEC Great Britain.....	188
ISO Norwegian/Danish.....	189
DEC Dutch.....	190
DEC Swiss.....	191
DEC Portuguese.....	192
VT100 Graphics.....	193
DEC Supplemental.....	194
DEC Technical.....	195
ISO Katakana.....	196
7-Bit Hebrew.....	197
7-Bit Turkish.....	198
Greek Supplemental.....	199
Hebrew Supplemental.....	200
Turkish Supplemental.....	201
LG Emulation 96-Character Sets.....	202
ISO Latin 2.....	203
ISO Latin 5.....	204
ISO Latin 9.....	205
ISO Cyrillic.....	206
ISO Greek.....	207
ISO Hebrew.....	208
B Interface Configuration with the VMS Operating System	
209	
Parallel Interface.....	209
Serial Interface.....	210
C Type Family IDs, Font IDs, Font File IDs.....	211
"Built-In" Font File IDs.....	211
Font File ID Field Definitions.....	212
Type Family IDs.....	213
Font File IDs.....	213
D Print Samples.....	221

Introduction	221
Creating Block Characters	221
Bar Codes.....	223
Logos	224
Sixel Graphics	224
Forms.....	225
Vertical Format Unit (VFU)	229
E Glossary	232
F Contact Information	244
Printronic Customer Support Center	244
Printronic Supplies Department	244
Corporate Offices.....	245

1 *Introduction*

About This Manual

This manual is designed so that you can quickly find the information you need to program the Printronix DEC LG emulation that is provided with your printer. Brief descriptions follow for each chapter in this book:

- **Chapter 1, “Introduction.”** Provides an overview of this book, printer features, and line matrix printing technology.
- **Chapter 2, “LG Emulation Control Codes.”** Describes the LG emulation control code commands that can be sent to the printer through the host data stream. These commands allow you to send instructions to the printer and configure many LG emulation parameters.
- **Chapter 3, “Character Sets.”** Includes tables that list the hexadecimal and decimal codes for the foreign language and special character sets provided by the LG emulation.
- **Chapter 4, “Bar Codes.”** Lists and describes the LG emulation control codes used for printing bar codes.
- **Appendices.** Several appendices provide character set charts for the LG emulation, and information on configuring the VMS™ operating system for use with the DEC LG printer.

How to Use This Manual

You can locate information three ways:

- Use the **Table of Contents** at the front of the manual.
- Use the **Glossary** at the back of the manual to find definitions for commonly used terminology.

Warnings and Special Information

Read and comply with all information highlighted under special headings:

WARNING Conditions that could harm you as well as damage the equipment.

CAUTION Conditions that could damage the printer or related equipment.

IMPORTANT Information vital to proper operation of the printer.

NOTE: Information affecting printer operation.

Related Documentation

Following is a list of related documentation for the DEC LG Emulation printer.

- *Printronix P8000 Series Maintenance Manual* - Explains how to maintain and repair the DEC LG Emulation line matrix printer at the field service level of maintenance. This manual covers alignments and adjustments, preventive and corrective maintenance, troubleshooting, and basic principles of operation.
- *Printronix P8000 User's Setup Guide* - Describes the keys on the control panel and provides quick reference information on daily printer operations such as loading paper and replacing ribbons.

- *Printronix P8000 LinePrinter Plus Programmer's Reference Manual* - Describes the host control codes and character sets available with the LinePrinter Plus® printer control language.
- *Printronix P8000 IGP/VGL Programmer's Reference Manual* - Provides information used with the optional Code V™ Printronix® emulation enhancement feature. The Code V Printronix emulation allows you to create and store forms; generate logos, bar codes, and expanded characters; create other graphics, and merge graphics with alphanumeric data as a document is printed.
- *Printronix P8000 IGP/PGL Programmer's Reference Manual* - Provides information used with the optional IGP®/PGL® Printronix emulation enhancement feature. The IGP Printronix emulation allows you to create and store forms; generate logos, bar codes, and expanded characters; create other graphics, and merge graphics with alphanumeric data as a document is printed.

The DEC LG Emulation Line Matrix Printer

The Printronix DEC LG Emulation printer is a line matrix printer. It uses a variable-speed shuttle, micro-step paper feed control, and multi-phase hammer firing to generate a wide range of horizontal and vertical dot densities with no speed penalties.

Printer Features

Several standard features are provided with the Printronix DEC LG Emulation printer, as described below.

Printer Emulations

Six printer emulations (or protocols) are selectable at the control panel:

- LG emulation
- Proprinter® XL emulation
- Epson® FX-1050 emulation
- P-Series emulation
- IGP/PGL - Printronix Graphics Language emulation (optional upgrade)
- IGP/VGL - Code V Graphics Language emulation (optional upgrade)

The DEC LG emulation may be configured using the emulation host control codes described in this book, or can be configured via the control panel, as described in the *Setup Guide*.

The Proprinter XL, Epson FX, and P-Series emulation host control codes are described in the *Printronix DEC LG Emulation LinePrinter Plus Programming Reference Manual*. (The LinePrinter Plus emulations can also be configured via the control panel, as described in the *Setup Guide*.) The PGL and VGL emulations are described in the user's manuals provided for those enhancement options.

Text Formatting and Language Options

You can modify several parameters used primarily for printing text, either by means of the host data stream or the configuration menus.

The text formatting and language options include:

- Selectable print quality
- Selectable alternate horizontal and vertical dot densities that enable you to tailor output to a wider variety of printing requirements

- Selectable forms length and width
- Character-by-character attribute specification
 1. Selectable pitch: normal, expanded, and compressed
 2. Bold print
 3. Overscoring
 4. Single underline
 5. Superscript and subscript printing
- Resident multinational character sets

Bar Code Formatting

Several LG emulation control codes that allow you to define and print bar codes are described in Chapter 4.

Diagnostics

The *Setup Guide* for these printers discusses the following diagnostic features in more detail:

- Built-in diagnostic self-tests
- Configuration printout
- Data stream hexadecimal code printout

Printing Speed

The speed at which text prints is measured in lines per minute (lpm). This speed is inversely proportional to the number of dot rows required to produce a character line, regardless of the number of characters in the line. More dot rows are required to print lowercase characters with descenders; consequently, those character lines print at a fractionally lower rate.

The DEC LG Emulation printer also prints dot-addressable graphic images. The speed at which graphics are plotted is measured in inches per minute (ipm). Unidirectional plotting produces slightly better print quality, and takes about twice as long as bidirectional plotting. You can select either plotting mode from the control panel.

Printing and plotting rates also vary according to the print quality you select. Print quality refers to the way you instruct the printer to create characters. If, for example, you select near letter quality (NLQ), the printer uses more dot rows to form characters than if you choose high speed (HS) print quality. Character formation and print speed are faster in HS because the printer uses fewer dot rows to form characters. Vertical dot density is thus a factor in printing speed. Nominal printing rates are charted in Appendix A of the *Setup Guide*.

2 *LG Emulation Control Codes*

LG Emulation

Emulation refers to the ability of a printer to execute the commands of other printer control languages. LG is the default printer emulation when the printer is powered on. If LG is not the active emulation, use the control panel configuration menus to select the LG option (refer to the *Administrator's Manual*).

A printer control language (also called a printer protocol) is the coding system used to convey, manipulate, and print data. It contains character codes and command sequences.

A printer and its host computer must use the same printer control language. In this manual, the terms printer control language, emulation, and protocol are synonymous.

Bar Code Printing

Bar code printing is selected by control sequences, not by the operator control panel. Bar code printing, including the control codes related to bar code printing, is described in Chapter 4 of this book.

Print Mode and Plot Mode

The DEC

LG Emulation provides a print mode and a plot mode for printing text and graphic elements, and a set of print fonts and plot fonts that are used in each mode. Some example print fonts and plot fonts are listed in the table of Ps2 values on page 73. A report of the available font files can be requested using the font status sequences (see page 74), if you have a serial connection to the printer.

In print mode, the DEC LG Emulation can print only the set of "print fonts." This mode is often preferable, because it is very fast and optimized for printing text. The quality of the print font determines the print density in this mode.

Plot mode handles graphic elements such as vectors and bar codes as well as many built-in DEC plot fonts. Because graphic elements and built-in DEC fonts are plotted, this mode is much slower than printer mode.

The printer will automatically switch between print mode and plot mode, depending on the current print requirements. The default mode is print mode, but the printer will often switch to plot mode when various densities are needed to plot graphic elements. For instance, the DECSGD command will allow many different combinations of horizontal and vertical densities that cannot be used in print mode.

Plot mode is performed in graphic passes. In other words, all elements in a given density are printed in the same paper motion. If the user chooses ten elements in one density and then changes to another density, the ten previous elements are printed and the paper moves forward in one pass. The elements printed at the new density may cause reverse paper motion, depending on where they are to be printed. Therefore, the user should consider this when combining elements of various densities on a form.

When choosing print or plot fonts via the SGR command, the user should also be aware that these fonts will only be used in their respective mode. For instance, if the printer is in print mode, a selection of a plot font will not be chosen until the printer is forced into plot mode. Likewise, if the printer is in plot mode and a print font is chosen, this font will not be active until the printer returns from plot mode to print mode.

Optimizing Print Mode

When you send a command such as SPI, DECASHORP, SHS, and SGR to the printer to alter character spacing, font size, and font attributes, the printer will switch to plot mode, causing the density to change and the printer throughput to decrease.

To optimize print mode, set the Print Mode option to Enable with the control panel. The switch to plot mode will be avoided and printer throughput will be increased considerably.

Optimizing Plot Mode

Print mode text and graphic elements print at different densities. When the two are mixed, a paper reversal can occur because of the different densities.

When the Plot Mode option is set to Enable from the control panel, Postnet barcodes are printed in a Data Processing density (120 x 75 dpi) in the following printing conditions:

1. Printer is currently in print mode.
2. Current density is 120 x 75 dpi.
3. Printer is in the portrait orientation.

Printing in Data Processing density speeds applications which use Postnet barcodes and text. It reduces the chances of reverse motion and improves throughput.

If the Plot Mode option is disabled, Postnet barcodes are printed in a Graphic density (via Plot Mode) as dictated by the DECSGD command.

Character Printing

Print data sent to the printer consist of two types of character codes:

- Printable Characters are codes representing alphabet characters, punctuation marks, and graphic symbols
- Control Codes are one or more bytes that instruct the printer how to process and print characters and graphics

The DEC LG Emulation processes the character codes of the DEC Multinational Character Set (page 15). Characters and codes from this chart are identified and located by their column and row numbers. For example, the ASCII character SUB is identified as 1/10, which means that it is located at column 1 row 10.

You may send data from the host computer in either 7-bit or 8-bit form. (The conversion processes from 7-bit to 8-bit form and vice versa are described on page 21.)

Printable Characters

Columns 0 through 7 of the DEC Multinational Character Set (page 15), are the standard ASCII printable character set used in a 7-bit environment. If you choose an 8-bit environment, the printable character set expands to include columns 8 through 15.

If word length is 7-bits, printable characters are only generated from columns 2 through 7. If word length is set at 8-bits, printable characters can be generated from columns 2 through 7 and columns 10 through 15. (Note that in an 8-bit environment, columns 0 through 7 have the 8th bit set to zero, while columns 8 through 15 always have the 8th bit set to 1.)

NOTE: The actual characters printed may not always be those shown in the DEC Multinational Character Set because printable characters in the column/row positions vary, depending upon the character set used.

DEC Multinational Character Set

DEC Multinational Character Set

KEY		BITS																																
B8	B7	B6	B5	BITS											ESCAPE SEQUENCES		CHARACTER																	
1	0	1	1	1	0	1	1	1	1	0	0	1	1	1	1	1	ESC																	
B4	B3	B2	B1	BITS											ESCAPE SEQUENCES		CHARACTER																	
1	0	1	1												ESC		OCTAL																	
																	DECIMAL																	
																	HEX																	
																	CHARACTER																	
COLUMN	0	1	2	3	4	5	6	7	8	9	10	11	12	13	14	15	16	17	18	19	20	21	22	23	24	25	26	27	28	29	30	31	32	33
0	NUL		SP	0	@	P	`	p		DCS	(Not Used)	*	À	À	á	Á		340	340		320	DO	DO	208	208	EO	EO	224	224	F0	F0	360		
1		DC1	!	A	Q		a	q				±	Á	Á	á	Á	Ñ	321	321		321	D1	D1	301	301	E1	E1	225	225	F1	F1	361		
2		"	"	B	R		b	r				2	À	À	á	À	Ò	322	322		322	D2	D2	302	302	E2	E2	226	226	F2	F2	362		
3		#	#	C	S		c	s				3	À	À	á	À	Ó	323	323		323	D3	D3	303	303	E3	E3	227	227	F3	F3	363		
4		EOT	\$	D	T		d	t	IND			4	À	À	á	À	Ô	324	324		324	D4	D4	304	304	E4	E4	228	228	F4	F4	364		
5		%	%	E	U		e	u	NEL			µ	À	À	á	À	Õ	325	325		325	D5	D5	305	305	E5	E5	229	229	F5	F5	365		
6		&	&	F	V		f	v				¶	À	À	á	À	Ö	326	326		326	D6	D6	306	306	E6	E6	230	230	F6	F6	366		
7		'	'	G	W		g	w				§	À	À	á	À	Ç	327	327		327	D7	D7	307	307	E7	E7	231	231	F7	F7	367		
8		BS	(H	X		h	x	HTS			ª	À	À	á	À	Ø	328	328		328	D8	D8	308	308	E8	E8	232	232	F8	F8	368		
9		HT)	I	Y		i	y				»	À	À	á	À	Ù	329	329		329	D9	D9	309	309	E9	E9	233	233	F9	F9	369		
10		LF	*	J	Z		j	z	VTS			ª	À	À	á	À	Ú	330	330		330	DA	DA	310	310	EA	EA	234	234	FA	FA	370		
11		VT	+	K	[k	{				ª	À	À	á	À	Û	331	331		331	DB	DB	311	311	EB	EB	235	235	FB	FB	371		
12		FF	,	L	\		l	}				ª	À	À	á	À	Ü	332	332		332	DC	DC	312	312	EB	EB	236	236	FC	FC	372		
13		CR	-	M]		m	~				¼	À	À	á	À	Ý	333	333		333	CC	CC	313	313	CB	CB	237	237	FD	FD	373		
14		SO	.	N	^		n	ˆ	SS2			½	À	À	á	À	ÿ	334	334		334	CD	CD	314	314	CB	CB	238	238	FE	FE	374		
15		SI	/	O	_		o	ˆ	SS3			¾	À	À	á	À	ÿ	335	335		335	CE	CE	315	315	CD	CD	239	239	FF	FF	375		

Selecting Graphic Character Sets

Several graphic character sets reside in DEC LG Emulation including U.S. ASCII, DEC Supplemental, DEC Technical, and VT100 Graphics.

Graphic character sets are selected for printing as follows:

1. Designate the set as one of the logical G0, G1, G2, or G3 sets.
2. Map (invoke) one of the G-sets into the graphic left (GL) or graphic right (GR) logical set. (In a 7-bit environment, only the GL set is available.)

Figure 1 shows the process of designating and invoking character sets. The Select Character Set (SCS) command designates the graphic character set (see page 67). The Locking Shift and Single Shift commands map the logical sets into the GL or GR set. See Locking and Single Shifts in this chapter.

When you select the character set using the control panel, it is done in two sections. Under the GL menu, selecting a different character set will put it in the logical G0 and G1 sets. GL is then mapped to G0.

Under the GR menu, choosing a character set will put it in the logical G2, G3, and User Preference Supplemental Set. GR is then mapped to G2.

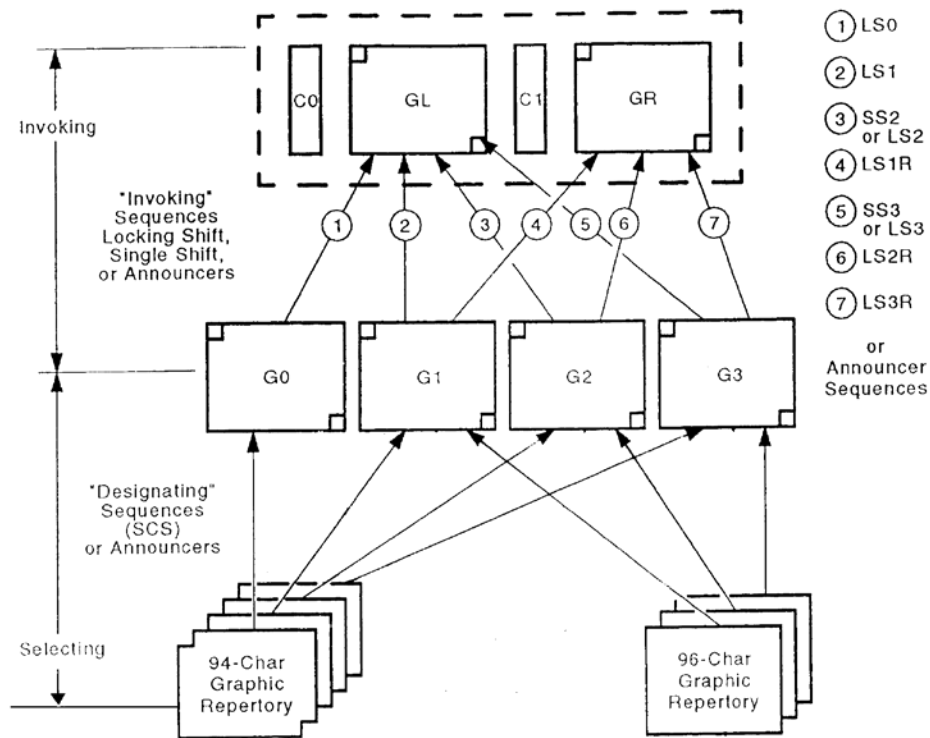

Figure 1 Designating and Invoking Character Sets

Control Code Types

Control codes do not print, they drive printer activity. The printer recognizes two kinds of control codes:

- Single-byte control codes
- Escape sequences that include two or more bytes of control code information

The following topics describe single-byte control codes and Escape sequences in detail.

Control Codes

A control code is a single (one-byte) non-printing character that instructs the printer to perform a specific operation. When the printer receives a control character, it immediately performs the control operation instead of printing a graphic character. The DEC LG Emulation printer recognizes two sets of control characters:

- ASCII control codes (7-bit codes)
- Additional control codes (8-bit codes)

ASCII Control Codes

Table 1 defines the ASCII control codes recognized by the printer in LG emulation mode. These codes are located in columns 0 and 1 of the Digital Multinational Character Set (page 15), and the column/row coordinates from this chart are printed beneath the Mnemonic category in Table 1. These control codes are available in a 7-bit data environment or in an 8-bit environment if bit 8 is set to 1.

NOTE: On many computers, an ASCII control code can be sent from the input keyboard by holding down the CTRL key while depressing the key specified in Table 1.

Additional Control Codes

The additional control codes are 8-bit control characters defined by ANSI and LG unique sequences, and are available in an 8-bit data environment when bit 8 is set to 1. Table 2 defines the additional control codes recognized by the printer in LG emulation mode. These codes are in columns 8 and 9 of the Digital Multinational Character Set (page 15), and the column/row coordinates from this chart are printed beneath the Mnemonic category in Table 2.

The 8-bit additional control codes may be sent in 7-bit form as equivalent escape sequences. Equivalent 7-bit escape sequences for the 8-bit additional control codes are listed in Table 3. Control code conversion from 7-bit to 8-bit data environments, and vice versa, is discussed on page 21.

Table 1 ASCII Control Codes

Mnemonic Column/Row	Name	Key Pressed with CTRL	Function
BEL 0/7	Bell	G	When a <BEL> control code is received, the printer produces a short audible tone.
HT 0/9	Horizontal Tab	I	HT advances the active tab position to the next horizontal tab stop on the line, or to the right margin if there are no more tab stops. The printer initially sets a horizontal tab stop every eight characters. Tab stops may be located either at column numbers or at physical positions on the page.
LF 0/10	Line Feed	J	LF advances the active line vertically by one line. If less than one vertical line space remains on the page, LF sets the active line to the first line on the next page. If line feed/new line (LNM) is set, LF also advances the active column to the left margin.
VT 0/11	Vertical Tab	K	VT moves the active line to the next vertical tab stop. The DEC LG Emulation printer initially sets a vertical tab stop for every line on the page.
FF 0/12	Form Feed	L	FF advances the active line to the first printable line on the next page.
CR 0/13	Carriage Return	M	CR returns the active column to the left margin. If carriage return/new line mode is set, CR also advances the active line to the next line.
SO 0/14	Shift Out	N	SO locks character set G1 into GL.
SI 0/15	Shift In	O	SI locks character set G0 into GL.
DC1 (XON) 1/1	Device Control 1	Q	DC1 informs the host computer that the printer is ready to receive data.
DC3 (XOFF) 1/3	Device Control 3	S	DC3 tells the host computer to pause before sending more data until the printer sends DC1.

Table 1 ASCII Control Codes

Mnemonic Column/Row	Name	Key Pressed with CTRL	Function
CAN 1/8	Cancel	X	CAN immediately ends an escape or control sequence. The printer interprets the characters following CAN as normal. CAN also cancels a Device Control String (DCS) when received within the command string of that DCS.
SUB 1/10	Substitute	Z	SUB immediately ends an escape or control sequence. SUB replaces a character received with an error in the sequence. SUB prints as a space character for sixel data.
ESC 1/11	Escape	[ESC introduces an escape or control sequence. If received in the middle of a sequence, ESC immediately ends the sequence and starts a new sequence. ESC also immediately ends a Device Control String (DCS).
BS 0/8	Backspace	H	BS moves the active horizontal position back one Horizontal Advance Increment.

Table 2 Additional Control Codes

Mnemonic Column/Row	Name	Function
IND 8/4	Index	IND moves the active position down to the same position on the next line. If the new position is below the bottom margin, the active position moves to the top of the next page.
NEL 8/5	Next Line	NEL moves the active position to the left margin on the next line. If the new position is below the bottom margin, the active position moves to the top of the next page.
HTS 8/8	Horizontal Tab Set	HTS sets a horizontal tab at the active column.
VTS 8/10	Vertical Tab Set	VTS sets a vertical tab at the active line.
PLD 8/11	Partial Line Down	PLD moves the active position down one-half line. The distance moved is specified as a parameter of the font, not by vertical spacing escape sequences.
PLU 8/12	Partial Line Up	PLU moves the active position up one-half line. The distance moved is specified as a parameter of the font, not by vertical spacing escape sequences.
RI 8/13	Reverse Index	RI moves the active line position up to the same position on the preceding line.
SS2 8/14	Single Shift 2	SS2 moves character set G2 into G1, to print one character.
SS3 8/15	Single Shift 3	SS3 moves character set G3 into G1, to print one character.
DCS 9/0	Device Control String	DCS introduces a device control string.
CSI 9/11	Control String	CSI introduces a sequence of one or more bytes that define a control function.
ST 9/12	String Terminator	ST indicates the end of a device control string (DCS).
9/DH-9/FH		<OSC>, <PM>, <APC>: See "note" below.

Table 3 Equivalent 7-Bit and 8-Bit Additional control Codes

Name	8-Bit Character Column/Row	7-Bit Sequence Column/Row
Index	IND 8/4	ESC D 1/11 4/4
Next Line	NEL 8/5	ESC E 1/11 4/5
Horizontal Tab Set	HTS 8/8	ESC H 1/11 4/8
Vertical Tab Set	VTS 8/10	ESC J 1/11 4/8
Partial Line Down	PLD 8/11	ESC K 1/11 4/11
Partial Line-Up	PLU 8/12	ESC L 1/11 4/12
Reverse Index	RI 8/13	ESC M 1/11 4/14
Single Shift 2	SS2 8/14	ESC N 1/11 4/14
Single Shift 3	SS3 8/15	ESC O 1/11 4/15
Device Control String	DCS 9/0	ESC P 1/11 5/0
Control String Introducer	CSI 9/11	ESC [1/11 5/12
String Terminator	ST 9/12	ESC \ 1/11 5/12

8-Bit to 7-Bit Control Code Conversion

Convert 8-bit additional control codes to 7-bit escape sequences as follows:

- Insert the ESC character.
- Set the eighth bit of the final character to 0 and set its seventh bit to 1.

NOTE: Only control codes found in columns 8 and 9 of the character sets may be converted as shown. Printable characters in columns 10 through 15 are not converted.

7-Bit to 8-Bit Control Code Conversion

Convert 7-bit escape sequences to 8-bit additional control codes as follows:

- Remove the ESC character.
- Set the eighth bit of the final character to 1 and set its seventh bit to 0.

Escape Code Sequences

The control codes discussed in the previous section are single-byte control codes. The number of printer capabilities is greatly increased, however, by combining character codes into escape sequences that contain two or more bytes of information. Escape sequences always begin with the ASCII ESCape character (location 1/11).

An ESC character in the data stream signals the printer to wait for special instructions. The character codes following the ESC character tell the printer what to do.

The printer in LG emulation mode recognizes three types of escape code sequence:

- Escape Sequences (do not include variable parameters)
- Control Sequences (include variable parameters)
- Device Control Strings (include variable parameters)

Escape Sequences

NOTE: Code sequences appear in this manual with spaces inserted between command elements. This is done for readability; do not insert spaces between code characters when you are programming unless the ASCII space character is part of a code sequence. For example, a code sequence printed in this manual as **ESC [1 ; 4 m is programmed as ESC[1;4m**

An escape sequence uses two or more bytes to define a specific printer control function, but does not include any variable parameters (although there may be intermediate characters). The format for an escape sequence is:

ESC	I	F
1/11	2/0 – 2/15	3/0 - 7/14
Escape Sequence Introducer	Intermediate characters(s)	Final character

After the escape sequence introducer, ESC, intermediate characters may or may not follow in the sequence. These characters always come from the 2/0 through 2/15 (column/row) range of the Digital Multinational Character Set (page 15). The final character signals the end of the escape sequence and always comes from the 3/0 through 7/14 range of the Digital multinational character set.

For example, if the intermediate character is SP (hex 20) and the final character is G (hex 47), the resulting escape sequence is ESC SP G (hex 1B 20 47). This particular sequence tells the printer how to process data it sends back to the host computer: send data in 7-bit form and send additional control characters as 7-bit escape sequences.

If the characters following the ESC code are not within the defined ranges, or if they are within the defined ranges but not recognized as a function of this printer, the entire sequence is ignored.

Control Sequences

Control sequences begin with the control sequence introducer, CSI (9/11), in an 8-bit data environment. They are also escape sequences, however, because the 8-bit CSI control character can be represented by the 7-bit escape sequence, ESC [. Control sequences may contain variable parameters within the command sequence. The format for control sequences is:

CSI	P	I	F	ESC
9/11	3/10 to 3/15	2/0 to 2/15	3/0 to 7/14	1/11 5/11
8-Bit Control Sequence Introducer	Parameter character(s)	Intermediate character(s)	Final character	7-Bit Escape Code CSI equivalent

Parameter characters modify the action or interpretation of the command sequence. There may be up to, but no more than, 16 parameters per sequence. The ; (3/11) (semicolon) character is the delimiter that separates parameters. This delimiter must be used whenever there are multiple parameters in the control sequence.

Two kinds of parameters are used: numeric and selective. A numeric parameter represents a numerical value. Numeric parameters are represented in this manual as Pn, Pn1, Pn2, etc. A selective parameter chooses an action associated with the parameter value. Selective parameters are represented in this manual as Ps, Ps1, Ps2, etc.

Parameters are interpreted as unsigned decimal integers with the most significant digit first. Parameter values greater than the maximum allowable 65535 will be set to 65535. Do not use a decimal point in any parameter - the printer will ignore the entire command. If no value is specified, zero (0) is assumed. A value of zero or an omitted parameter indicates the printer default value should be used for that sequence.

If the printer receives the parameter characters 3AH, 3DH, or 3EH anywhere in the parameter string, it performs no action until the final character is received, then ignores the entire sequence. These parameter characters are sixel control codes and must not conflict with CSI sequences.

A CSI sequence containing one or more group(s) of invalid parameters is still processed, but only the valid parameters are used. If all parameters in a sequence are out of range or invalid, the printer waits for the final character, then ignores the entire sequence.

Intermediate and final characters define the control function. For example, the sequence, ESC [3 m (hex 1B 5B 33 6D), turns italic printing on. This sequence uses one selective parameter [3], no intermediate characters, and the final character [m].

The DEC LG Emulation processes control sequences with one intermediate character only. If more than one intermediate character is received, the printer waits for the final character, then ignores the entire control sequence. If no intermediate characters are in the sequence, the final character determines the control function.

Device Control Strings

The format of a device control string is:

DCS	P...P	I...I	F	D...D	F
9/0	3/0 to 3/15	2/0 to 2/15	3/0 to 7/14		9/12
8-Bit Device Control String Introducer	Parameter character(s)	Intermediate character(s)	Final character	Data (0 or more characters)	String Terminator
Introducer	Protocol Selector				

The DCS control character is the Device Control String introducer. DCS has an 8-bit code of 9/0. This is equivalent to the escape sequence consisting of the ESC (1/11) and P (5/0) characters. Both encodings are recognized as DCS. After DCS is received, all characters received up to and including the String Terminator (ST) are not printed but are stored as part of the control string.

The protocol selector consists of parameter characters (P...P), intermediate characters (I...I), and the final character. These characters are processed identically to the format of a control sequence (see previous section). The intermediate characters, if any, and the final character, specify the meaning of the data. If present, the parameter string can further elaborate the interpretation of the data.

If the protocol selector is parsed but not recognized, all data that follows is ignored until it is either terminated by ST or aborted.

Special Parsing Requirements

Parsing is the process of separating a programming statement into basic units that can be translated into machine instructions. Special parsing requirements are necessary when invalid parameters are specified, when invalid control functions are specified, and when control characters are embedded in control functions. Generally, the printer recovers from these conditions by performing as much of the function as possible (or, parsing the valid parameter from the invalid).

When control sequences are not recognized by the printer or when selective parameters are invalid, the printer ignores them. Parameter values greater than the specified limit are set to the maximum allowable value for that parameter. If a C0 (7-bit) control character is received within a control sequence, the control character is executed by the printer as if it was received before the control sequence. Parsing then resumes. The exceptions to this rule follow:

- When the control character is <CAN> (18 hex) or <SUB> (1A hex), the sequence is aborted and the control character processed.
- If the control character is ESC (1B hex), the sequence is aborted and a new sequence begins.
- If a C1 (8-bit) control character is received within an escape or control sequence, the sequence is aborted and the C1 control character is then processed, if it is applicable to the printer. If not, it is ignored.
- When the (A0 hex) character is received within a control sequence, it is processed as a <Space> (20 hex) character, and parsing then resumes.
- If character (FF hex) is received within a control sequence, it is processed as a (7F hex) character, then parsing resumes.
- When a GR character is received during a control sequence, the eighth bit is ignored. The remaining seven bits define a GL character.

The following messages explain error codes that might arise when using the single shift control character:

- If a C0 or C1 control character is received after a single shift control character <SS2> (8E hex) or <SS3> (8F hex), the control character is processed and the single shift flag remains set. If a control sequence is received after <SS2> (8E hex) or <SS3> (8F hex), the sequence is processed and the single shift flag remains set.

When the characters <SP> (20 hex) or (7F hex) are received after an SS2 or SS3, the following occurs:

- If the (94) character set resides in the set being accessed (either G2 or G3), the <Space> or keys are processed and the single shift flag remains set.
- If the (94) character set resides in the set being accessed (either G2 or G3), the printer images the corresponding character of that set (A0 hex or FF hex), then resets the single shift flag.
- If a GR character is received after an SS2 or SS3 sequence, the eighth bit is ignored. The single shift function then applies the remaining seven bits to define a GL character.

NOTE: An error condition exists any time a GR character follows an SS2 or SS3 sequence. The software should never send a GR character after an SS2 or SS3 character.

If either (A0 hex) or (FF hex) are received after SS2 or SS3, the following occurs:

- The DEC LG Emulation prints the error character (a reverse question mark) and resets the single shift flag when a (94) character resides in the set being accessed (either G2 or G3).
- If a (96) character resides in the set being accessed (either G2 or G3), the printer images the corresponding character, (A0 hex) or (FF hex), of that set, then resets the single shift flag.

Control Code Description Format

The rest of this chapter discusses the control codes in detail. Where applicable, the following information is listed for each control code sequence:

Name The title or function of the control code. The LG or ASCII mnemonic is in parentheses after the name.

ASCII Code The ASCII name for the control code. Escape sequences are in 7-bit (ASCII) form.

NOTE: In the code descriptions, the ASCII space character (2/0, hex 20, decimal 32) is represented by SP.

Hex Code The code or escape sequence in hexadecimal numbers.

Dec Code The code or escape sequence in decimal numbers.

Purpose The function(s) of the control code.

Discussion A discussion of the uses of the sequence, and descriptions of any exceptions or limitations to use.

Control Code Index

The LG emulation mode control codes listed below are grouped by related functions.

Control code sequences in this manual are shown in 7-bit form. They can be either 7-bit or 8-bit form, depending on your requirements. Code conversion instructions are on page 21.

For commands that turn features on and off (set/reset, enable/disable), the page number for the enabling command is listed. The disabling command is on the same page.

IMPORTANT In the index below, SP represents the ASCII space character (decimal 32, 20_H). (A two-digit number followed by a subscripted capital “H” is a hexadecimal number. Numbers without subscripts are decimal numbers.)

FUNCTION	CODE	PAGE
Set/Reset Mode	ESC[Psh/ESC[PsI	page 29
Line Feed/New Line Mode (LNM)	ESC[20h	page 30
Carriage Return/New Line Mode (DECCRNLM)	ESC[?40h	page 31
Autowrap Mode (DECAWM)	ESC[?7h	page 31
Pitch Select Mode (DECPSM)	ESC[?29h	page 31
Set Page Orientation (DECSP0)	ESC[Ps&z	page 32
Position Unit Mode (PUM)	ESC[11h	page 32
Force Plot Mode (DECFFPM)	ESC[?70h	page 33

FUNCTION	CODE	PAGE
Select Size Unit (SSU)		page 34
Graphic Size Selection (GSS)	ESC[PnSPC	page 34
Graphic Size Modification	ESC[Pn1;Pn2SPB	page 35
Setting Plot Density		page 35
Select Graphics Density (DECSGD)	ESC[Psh;Psv+{	page 35
Spacing		page 37
Spacing Pitch Increment (SPI)	ESC[Pn1;Pn2SPG	page 38
Select Vertical (Line) Spacing (SVS)	ESC[PsSPL	page 39
Set Vertical Pitch (DECVERP)	ESC[Psz	page 39
Select Horizontal (Character) Spacing (SHS)	ESC[Psw	page 40
Set Horizontal Pitch (DECSHORP)	ESC[Psw	page 40
Vertical Format		page 41
Load Vertical Format Unit (VFU)	ESC[<1h	page 42
End Load (VFU)	ESC{<11	page 42
Channel Command	ESC[pl&y	page 43
Forms		page 44
Loading Forms Sequence (DECLFM)	DCSP1;P2&pRecordsST	page 44
Form Types		page 46
Start Forms Sequence (DECIFM)	DCSP1&rFormNameST	page 47
Terminate Forms Sequence (DECTFM)	ESC[#SP1	page 47
Delete Forms Sequence (DECDFM)	DCSPs&	page 48
Forms Considerations		page 48
Request Forms Status (DECRFMS)	CSI&-	page 49
Form Status Report (DECFMSR)	DCS&sFormsStringST	page 49
Logos		page 49
Loading Logos Sequence (DECLLG)	DCSP1;P2&tRecordST	page 49
Select Logo Sequence (DECILG)	CSIPn&}	page 50
Deleting Logos Sequence (DECDLG)	CSIP1;P2Pn&	page 51
Request Logo Status (DECRLGS)	CSI'p	page 51
Logo Status Report (DECSLGS)	DCS&wLogoStringST	page 51
Page Print Area and Margins		page 52

FUNCTION	CODE	PAGE
Page Format Select (PFS)	ESC[PsSPJ	page 54
Set Lines Per Physical Page (DECSLPP)	ESC[Pnt	page 58
Set Top and Bottom Margins (DECSTBM)	ESC[Pn1;Pn2r	page 58
Set Left and Right Margins (DECSLRM)	ESC[Pn1;Pn2s	page 59
Active Column and Active Line (“Cursor” Motion)		page 60
Forward Index (IND)	ESC D	page 60
Reverse Index (RI)	ESC M	page 60
Next Line (NEL)	ESC E	page 61
Horizontal Position Absolute (HPA)	ESC[Pn’	page 61
Horizontal Position Relative (HPR)	ESC[Pna	page 61
Horizontal Position Backward (HPB)	ESC[Pnj	page 61
Vertical Position Absolute (VPA)	ESC[Pnd	page 62
Vertical Position Relative (VPR)	ESC[Pne	page 62
Vertical Position Backward (VPB)	ESC[Pnk	page 62
Cursor Up (CUU)	ESC[PnA	page 62
Partial Line Up (PLU) - Superscription	ESC L	page 63
Partial Line Down (PLD) - Subscription	ESC K	page 63
Tab Stops		page 63
Set Horizontal Tab Stops (DECSHTS)	ESC [Pn;...;Pnu	page 63
Horizontal Tab Stops (HTS)	ESC H	page 64
Set Vertical Tab Stops (DECSVTS)	ESC[Pn;...;Pnv	page 64
Vertical Tab Stops (VTS)	ESC J	page 65
Tab Clear (TBC)	ESC[Psg	page 65
Character Set Selection (SCS)		page 66
Select Character Set Sequences		page 67
Assign User Preference Supp. Set (DECAUPSS)	DCS Ps !uD...DST	page 68
Product Identification (DA)	ESC[c or ESC[0c	page 69
Printer Status Requests and Reports		page 69

FUNCTION	CODE	PAGE
Device Status Requests (DSRs) and Printer Responses		page 70
Send Extended Status Report	ESC[n or ESC[0n	page 70
Disable Unsolicited Status Reports	ESC[?1n	page 70
Enable Unsol. Brief Reports and Send Ext. Report	ESC[?2n	page 70
Enable Unsol. Ext. Reports and Send Ext. Report	ESC[?3n	page 70
Assigning and Selecting Font Files		page 72
Assign Type Family or Font (DECATFF)	DCSPs1;Ps2}IDStringST	page 73
Selecting Fonts for Printing (SGR)	CSIPsm	page 74
Deleting Fonts from RAM (DECLFF)	DCSO;1;0yST	page 75
Font Status Sequences		page 75
Request Font Status (DECRFS)	CSIPs;Ps”{	page 75
Font Status Report (DECFSR)	DCSI”{StringST	page 76
Character Attributes (SGR)	ESC[Psm	page 76
Character Expansion (GSM)	ESC[Pn1;pn2SP B	page 77
Bold Printing	ESC[Psm	page 78
Crossed-Out Text	ESC[Psm	page 79
Double-Underlined Text	ESC[Psm	page 79
Italic Printing	ESC[Psm	page 80
Overlined Text	ESC[Psm	page 80
Turn Off All Attributes	ESC[0m	page 80
Underlined Text	ESC[Psm	page 81
Justification (JFY)	ESC[PsSPF	page 81
Sixel Graphics Processing		page 82
Character Processing in Sixel Graphics Mode	ESC[Psm	page 85
Drawing Vectors (DECVEC)	ESC[Pn1;Pn2;Pn3;Pn4;Pn5;!	page 91
Block Characters		page 91
Setting Block Character Parameters (DECBCS)	ESC[P1;P2;...P5'r	page 92
Start Block Character Mode (DECBLOCKC)	ESC%SP1	page 93
Stop Block Character Mode	ESC%@	page 94

FUNCTION	CODE	PAGE
Printer Reset		
Reset to Initial State (RIS)	ESC c	page 94
Soft Terminal Reset (DECSTR)	ESC[!p	page 94
Selecting and Returning from LinePrinter Plus Emulations		
Select LinePrinter Plus Emulations via (DECIPEM)		page 94
Select LinePrinter Plus Emulations via (SOCS)		page 95
7-Bit and 8-Bit Transmission and Interpretations		page 96
Draft Mode Printing		
Enter Draft Mode	ESC%/3	page 96
Exit Draft Mode	ESC%@	page 96
Default Values and States		page 97
Bar Codes		Chapter 4

Set/Reset Mode

	Set (Enable)	Reset (Disable)
ASCII Code	ESC [Ps h	ESC [Ps l
Hex Code	1B 5B Ps 68	1B 5B Ps 6C
Dec Code	27 91 Ps 104	27 91 Ps 108
Purpose	Turns basic printing features on (set) or off (reset).	
Discussion	<p>Set/Reset Mode controls certain printer features that have two settings: on or off. One sequence may be used to turn several features on or off. Parameter values <i>Ps</i> determine different printer modes.</p> <p>Parameter values are either ANSI or LG private. All parameters in a given sequence must be of the same type. LG private parameters are preceded by the question mark (“?”) character.</p> <p>On Set/Reset features, default settings go into effect when the printer is powered-up or a reset (RIS or DECSTR) sequence is sent.</p>	

Table 4 Set/Reset Mode Parameter Values

Ps (Parameter Values)	Printer Mode	Page No.
ANSI		
11	Position Unit Mode (PUM)	page 32
20	Line feed/New line Mode (LNM)	page 30
DEC Private		
?7	Autowrap Mode (DECAWM)	page 31
?29	Pitch Select Mode (DECPSM)	page 31
?40	Carriage Return/New Line Mode (DECCRNLM)	page 31
?70	Force Plot Mode (DECFFM)	page 33

Line Feed/New Line Mode (LNM)

	Set (Enable)	Reset (Disable)
ASCII Code	ESC [2 0 h	ESC [2 0 l
Hex Code	1B 5B 32 30 68	1B 5B 32 30 6C
Dec Code	27 91 50 48 104	27 91 50 48 108

Purpose Defines the paper position according to how the line feed features are enabled.

Discussion Advance the paper up one line by pressing the line feed key once. A half-second pause ensues, then the paper will feed one line. To feed paper continuously, hold down the line feed key. After a half-second pause, the paper feeds up one line in 3-hertz intervals.

To enable further line feed features, (i.e., microstepping), raise the printer cover and locate the control panel on the left side. Four keys-UP, NEXT, DOWN, and PREV-control additional line feed capabilities:

To move the paper up 1/600 inch, press the LINE FEED key and the NEXT key together. For continuous forward paper feed at 1/600 inch, hold down the LINE FEED key and the NEXT key; the paper will feed at 3-hertz intervals after a half- second pause.

Whether Line Feed/New Line mode is enabled or disabled, a Carriage Return <CR> control code is interpreted according to the DECCRNLM mode in use. (See Carriage Return/New Line Mode (DECCRNLM) page 31.)

LNM remains as selected from the last power-on session. Factory default is LNM reset.

Carriage Return/New Line Mode (DEC CRNLM)

	Set (Enable)	Reset (Disable)
ASCII Code	ESC [? 4 0 h	ESC [? 4 0 l
Hex Code	1B 5B 3F 34 30 68	1B 5B 3F 34 30 6C
Dec Code	27 91 63 52 48 104	27 91 63 52 48 108
Purpose	Defines printer response to the Carriage Return (CR) character.	
Discussion	When the printer receives the CR character with Carriage Return/New Line Mode enabled (set), it returns the active column to the left margin and advances paper one line. When the printer receives the CR character with Carriage Return/New Line Mode disabled (reset), it returns the active column to the left margin without advancing the active line. LNM remains as selected from the last power-on session. The factory default is LNM reset.	

Autowrap Mode (DECAWM)

	Set (Enable)	Reset (Disable)
ASCII Code	ESC [? 7 h	ESC [? 7 l
Hex Code	1B 5B 3F 37 68	1B 5B 3F 37 6C
Dec Code	27 91 63 55 104	27 91 63 55 108
Purpose	Determines what happens when text exceeds the right margin of the page.	
Discussion	When autowrap is enabled (set) and text runs past the right margin, the active position moves to the left margin on the next line, and no data are lost. When autowrap is disabled (reset) and text runs past the right margin, the data are lost. DECAWM remains as selected from the last power-on session. Factory default is DECAWM reset.	

Pitch Select Mode (DECPSM)

	Set (Enable)	Reset (Disable)
ASCII Code	ESC [? 2 9 h	ESC [? 2 9 l
Hex Code	1B 5B 3F 32 39 68	1B 5B 3F 32 39 6C
Dec Code	27 91 63 50 57 104	27 91 63 50 57 108
Purpose	Controls the Set Horizontal Pitch (DEC SHORP) sequence.	
Discussion	When Pitch Select Mode is enabled (set), the current font determines the horizontal pitch. When Pitch Select Mode is disabled (reset), the printer uses the horizontal pitch selected by the Set Horizontal Pitch (DEC SHORP) sequence. The power-up default is DECPSM reset. DECPSM is overridden by an SPI command (page 38) or an SHS command (page 40).	

Set Page Orientation (DECSP0)

ASCII Code ESC [Ps & z

Hex Code 1B 5B Ps 26 7A

Dec Code 27 91 Ps 38 122

Purpose Sets the intended reading orientation of the page with respect to the paper feed direction.

Discussion DECSP0 is similar to the page orientation defined by PFS, but has no effect on the page size or number of lines and columns. All page related functions are interpreted in relation to page orientation (margins, line and character spacing).

The default value is Ps = 0.

The selective parameters indicate the following:

Ps	Function
0	Portrait: Page orientation is in line with the paper feed direction
1	Landscape: Page orientation is perpendicular to the paper feed direction.

Position Unit Mode (PUM)

Set (Enable) **Reset (Disable)**

ASCII Code ESC [1 1 h ESC [1 1 1

Hex Code 1B 5B 31 31 68 1B 5B 31 31 6C

Dec Code 27 91 49 49 104 27 91 49 49 108

Purpose Selects a unit of measurement used with the escape sequences that control spacing parameters.

Discussion When Position Unit mode is enabled (set), it selects either decipoints or pixels, depending on the setting of the Select Size Unit (SSU) sequence.

When Position Unit mode is disabled (reset), it selects a spacing unit equal to one character position called a character cell. The width and height of the cell is equal to the currently selected horizontal and vertical spacing increment.

Power-up default is PUM reset.

Table 5 lists the escape sequences affected by the PUM and SSU settings.

Table 5 Escape Sequences With Spacing Parameters

Sequence Name	DEC Mnemonic	Page No.
Spacing Pitch Increment *	SPI*	page 38
Set Lines Per Physical Page	DECSLPP	page 58
Set Top and Bottom Margins	DECSTBM	page 58
Set Left and Right Margins	DECSLRM	page 59
Horizontal Position Absolute	HPA	page 61
Horizontal Position Relative	HPR	page 61
Horizontal Position Backward	HPB	page 61
Vertical Position Absolute	VPA	page 62
Vertical Position Relative	VPR	page 62
Vertical Position Backward	VPB	page 62
Set Horizontal Tab Stops	DECSHTS	page 63
Set Vertical Tab Stops	DECSVTS	page 64
Drawing Vectors*	DECVEC*	page 91
Select Barcode Parameters	DECSBCA	page 151
* Not affected by PUM setting.		

Force Plot Mode (DECFFPM)

	Reset (Disable)	Set (Enable)
ASCII Code	ESC [? 7 0 l	ESC [? 7 0 h
Hex Code	1B 5B 3F 37 30 6C	1B 5B 3F 37 30 68
Dec Code	27 91 63 55 48 108	27 91 63 55 48 104
Purpose	Forces the printer to enter or stay in Plotting mode.	
Discussion	<p>The printer normally operates in Printing mode (the default) to achieve maximum throughput of standard fonts and spacing. Plotting mode sacrifices speed but offers greater flexibility, such as special fonts, font sizes, and character spacing.</p> <p>Many of these features are available in print mode when the Print Mode option is set to Enable with the control panel.</p> <p>Force Plot mode prevents accidental shifting between the printed and plotted fonts, and can reduce unnecessary paper shift. The default for DECFFPM = reset state.</p> <p>For further information about plot mode, see overview description on page 13.</p>	

Select Size Unit (SSU)

ASCII Code ESC [Ps SP I

Hex Code 1B 5B Ps 20 49

Dec Code 27 91 Ps 32 73

Purpose Works with the Position Unit Mode (PUM) sequence to select a unit of measurement for spacing parameters.

Discussion When PUM is enabled (set), Select Size Unit selects either decipoints or pixels as the spacing unit, depending on the parameter settings shown below.

If the printer receives an SSU while PUM is disabled (reset), the selected unit will take effect when PUM is set and will then remain in effect until the printer receives either another SSU or a reset sequence. Default value at power-up or reset is decipoints. The printer will ignore all Ps values other than 2 or 7.

Ps	Spacing Unit
2	Decipoint (1/720 inch)
7	Pixel (1/600 inch)

The printer converts decipoints (D) into pixel (P) values by using the formula shown below and rounding off the result to the nearest integer:

$$P = \frac{D \times 5}{6}$$

All arithmetic operations are performed using integer instructions. For example, the formula above converts decipoints to the nearest pixel.

NOTE: If you select decipoint units, do not use horizontal position relative (HPR) and vertical position relative (VPR) sequences. Using these commands with decipoint units produces cumulative positioning errors because they are rounded-off.

NOTE: The JIS Katakana character set is only available in the 10 CPI font size. The GSS and SSU control codes can only be used with these character sets if 10 CPI is specified.

Graphic Size Selection (GSS)

ASCII Code ESC [Pn SP C

Hex Code 1B 5B Pn 20 43

Dec Code 27 91 Pn 32 67

Purpose Sets the height and width of all characters in the selected font that start after the control sequence.

Discussion Pn is a decimal value that species the height of the font in units determined by the Select Size Unit (SSU) sequence. The width of the font is implicitly defined by the height. For example, the width of a 10-point font is 10 pitch. The initial value for Pn is Pn = 100.

If the desired font height cannot be matched exactly, the next smallest available font is selected. The GSS sequence remains in effect until the printer receives another GSS sequence or a Graphic Size Modification (GSM) sequence.

NOTE: The JIS Katakana character set is only available in the 10 CPI font size. The GSS and SSU control codes can only be used with these character sets if 10 CPI is specified.

Graphic Size Modification (GSM)

ASCII Code ESC [Pn1 ; Pn2 SP B

Hex Code 1B 5B Pn1 3B Pn2 20 42

Dec Code 27 91 Pn1 59 Pn2 32 66

Purpose Modifies the height and width for all designated fonts as set by the GSS sequence.

Discussion Pn1 is a decimal value that specifies the height of the font as a percentage of the height set by the GSS sequence. Pn2 is a decimal value that specifies the width as a percentage of the width set by the GSS sequence. Data processing fonts can be modified by two or three times their default height and two times their default width.

GSM affects only the current print or plot mode. In Print mode, GSM always changes the current pitch according to the newly selected font. In Plot mode, the pitch is changed only if Pitch Select mode is set.

The GSM sequence is effective until the printer receives another GSM or GSS sequence.

NOTE: The GSM command will only work if the base font is DP 10. See the DECATFF command.

Setting Plot Density

The printer can plot in several different densities (dots per inch, or dpi), from 30 dpi to 200 dpi.

The Plot mode fonts contain the information for the vertical and horizontal densities they use. Determine non-text imaging densities (for sixels, bar codes) by using these innate commands. Default values for both the vertical and horizontal densities for graphic work are 100.

While density changes can occur anywhere on a page, they can also cause vertical negative paper motion while printing. Judicious planning minimizes this effect.

Plot speed is adversely affected by changes in density: the higher the density, the slower the speed. Hence, plotting in 50 x 50 density is four times faster than plotting in 100 x 100. If speed is a consideration, select lower density plotting. The lowest density plot font available is the 60 x 75 density.

Set Graphics Density (DECSGD)

ASCII Code ESC [Psh ; Psv & {

Hex Code 1B 5B Psh 3B Psv 26 7B

Dec Code 27 91 Psh 59 Psv 38 123

Purpose Sets the darkness of drawn images.

Discussion DECSGD controls darkness via the density of the physical pixels. It does not change the resolution of the image (logical pixels), only the darkness of the segments drawn.

NOTE: Psh and Psv do not affect the density of plotted text.

Text density comes from the current font.

DECSGD sets the density for graphics (sixels, logos, vectors, block characters, and bar codes). The selective parameters, Psh and Psv, designate the horizontal and vertical dot densities used for plotting graphics.

- Psh Parameter (Psh) selects the horizontal dot density.
- Psv Parameter (Psv) selects the vertical dot density.

The actions of Psh and Psv are dependent on the print orientation because x-direction print densities differ significantly from y-direction print densities. (This is the only printer instruction that is directly dependent on the current orientation setting.) Table 6 defines how orientation is designated by Psh and Psv.

Table 6 Psh and Psv Orientation

Direction	Portrait (Default)	Landscape
horizontal (Psh)	same as x	same as y
vertical (Psv)	same as y	same as x
x-density	same as horizontal	same as vertical
y-density	same as vertical	same as horizontal

Use Table 7 and Table 8 with Table 6 to establish the exact orientations designated by Psh and Psv.

Table 7 X-Density Values

Psh (Portrait-dflt)	X-Density (Dots/Inch)
0	No change
1	50
2	60
3	70
4	80
5	90
6	100 (default)
7	110
8	120
9	130
10	140
11	150
12	200

Table 8 Y-Density Values

Psv (Portrait-dflt)	Y-Density (Dots/Inch)
0	No change
1	30
2	40
3	50
4	60
5	66.67
6	75
7	86
8	100 (default)
9	120
10	150
11	200

Spacing

The five spacing sequences covered in this section affect the spacing of lines and characters. Horizontal pitch affects character spacing in characters per inch (CPI). Vertical pitch affects line spacing in lines per inch (lpi). DECShORP and SHS affect character size in addition to spacing if Print Mode is set to Enable with the control panel.

Table 9 Line and Character Spacing Sequences

Sequence Name	DEC Mnemonic	Page No.
Spacing Pitch Increment	SPI	page 37
Select Vertical Spacing	SVS	page 39
Set Vertical Pitch	DECVERP	page 39
Select Horizontal Spacing	SHS	page 40
Set Horizontal Pitch	DECShORP	page 40

Horizontal and vertical pitch values can be changed by using the Select Horizontal Spacing (SHS) and Select Vertical Spacing (SVS) sequences or the Spacing Pitch Increment (SPI) sequence. These sequences can accept two spacing units: decipoints or pixels. To select the unit of measurement, use the Position Unit Mode (PUM) and Select Size Unit (SSU) sequences. Alternatively, you can use Set Horizontal Pitch (DECShORP) and Set Vertical Pitch (DECVERP) sequences to alter spacing.

Except for DECShORP, all spacing commands are acted upon as soon as they are received, and the new spacing increments take effect immediately.

Spacing Pitch Increment (SPI)

ASCII Code ESC [Pn1 ; Pn2 SP G

Hex Code 1B 5B Pn1 3B Pn2 20 47

Dec Code 27 91 Pn1 59 Pn2 32 71

Purpose Sets the vertical and horizontal spacing increments for all characters that follow in the data stream. You can select one or both increments with a single Spacing Pitch Increment sequence. The SPI sequence gives you the greatest flexibility in adjusting white space (pitch) between characters and lines.

Discussion This command sequence uses decipoints or pixels as units. Select the unit with the Select Size Unit (SSU) sequence. Spacing Pitch Increment is not affected by the Position Unit Mode (PUM) sequence or by the page orientation. For example, if you set a vertical increment of 100 pixels (or 1/6 inch), the printer uses this setting for both portrait and landscaped pages.

Pn1 selects the vertical spacing increment. Pn2 selects the horizontal spacing increment. Parameters must be positive integers. If you use a decimal point, the printer will ignore the command. Printer default values are Pn1 = 0 and Pn2 = 0, which selects the spacing of the current font.

You can change the SPI setting for horizontal spacing in three ways:

- Use another SPI sequence.
- Use a Select Horizontal Spacing (SHS) sequence.
 - Use a combination of the Pitch Select Mode (DECPSM) and Select Horizontal Pitch (DECSHORP) sequences. Most combinations are acceptable for this function.

You can change the SPI setting for vertical spacing in two ways:

- Use a Set Vertical Spacing (SVS) sequence.
- Use a Set Vertical Pitch (DECVERP) sequence.

NOTE: If Pn1 or Pn2 is 0 (or omitted), the printer defaults to the font file pitch setting.

If you set the Print Mode option to Enable with the control panel, this command will not force the printer into plot mode. The current print font will be used and throughput will be at its maximum.

If the Print Mode option is set to Disable, this command forces the printer into plot mode. If a position command does not precede the printable (graphic) character, the printer will place that character to the right of the previously received character.

The distance between characters depends on the values of Pn1 and Pn2 in the most recent SPI, SHS, or DECCHORP sequence. If you set the Pn1 or Pn2 values to 0, or if you do not send an SPI sequence, the printer uses the default horizontal and vertical spacing for the font currently in use.

Horizontal spacing is the same for all font styles.

Select Vertical (Line) Spacing (SVS)

ASCII Code ESC [Ps SP L

Hex Code 1B 5B Ps 20 4C

Dec Code 27 91 Ps 32 76

Purpose Selects the vertical spacing (pitch) between lines that is used by all fonts.

Discussion Ps selects the vertical pitch and vertical character position unit. SVS does not affect the vertical size of the selected font.

Ps	Vertical Pitch	Vertical Character Positioning Unit
0	6 lines per inch	1/6 inch (default)
1	4 lines per inch	1/4 inch
2	3 lines per inch	1/3 inch
3	12 lines per inch	1/12 inch
4	8 lines per inch	1/8 inch
5	5 lines per inch	1/5 inch
9	2 lines per inch	1/2 inch
10	10 lines per inch	1/10 inch

Set Vertical Pitch (DECVERP)

ASCII Code ESC [Ps z

Hex Code 1B 5B Ps 7A

Dec Code 27 91 Ps 122

Purpose Selects the number of lines printed per inch on the page.

Discussion Selects the line spacing (vertical pitch) used with all fonts.

Ps selects the vertical pitch (lines per inch).

Ps	Vertical Pitch
0	6 lines per inch (current default)
2	8 lines per inch
7	10 lines per inch (This setting is accomplished by reversing the paper.)

Changing vertical pitch to 8 lpi or 10 lpi alters the physical size of the form, since form length is specified in terms of lines per page.

Vertical tab stops are not affected by changes to vertical pitch. For example, a vertical tab at line 15 remains set even if you change vertical pitch from 6 lpi to 10 lpi.

Select Horizontal (Character) Spacing (SHS)

ASCII Code ESC [Ps SP K

Hex Code 1B 5B Ps 20 4B

Dec Code 27 91 Ps 32 75

Purpose Selects character spacing (horizontal pitch).

Discussion Ps selects the horizontal pitch and the horizontal character position unit. If Print Mode is set to Enable from the control panel, Ps will change the character size with respect to the selected pitch. If set to Disable, only the white space between characters varies.

Ps	Horizontal Pitch	Horizontal Character Position Unit
0	10 characters per inch	1/10 inch
1	12 characters per inch	1/12 inch
2	15 characters per inch	1/15 inch
3	6 characters per inch	1/6 inch

NOTE: If the Print Mode option is set to Disable with the control panel, the SHS command can force the printer into plot mode. If the page contains a dense concentration of text (many text lines and many characters per line), the SHS command will cause the DEC LG Emulation to pause a few seconds between pages.

To ensure faster text printing, select an appropriate font and character size setting with DECATFF, SGR instead of SHS. If the Print Mode is set to Enable with the control panel, this command will not force the printer into plot mode and there should be no pause between pages.

Set Horizontal Pitch (DEC SHORP)

ASCII Code ESC [Ps w

Hex Code 1B 5B Ps 77

Dec Code 27 91 Ps 119

Purpose Selects the character spacing for monospaced fonts. This sequence selects the number of characters printed per horizontal inch on a line. If the Print Mode option is set to Enable with the control panel, the character size will change to match the selected pitch. If Print Mode is set to Disable, only the white space between the characters varies and can force the printer into plot mode.

Discussion Pitch Select Mode (DECPSM) activates the Set Horizontal Pitch (DEC SHORP) sequence. When DECPSM is set (enabled), the printer uses the horizontal pitch of the

current font. When DECPSM is reset (disabled), the printer uses the horizontal pitch selected by the last DECSHORP sequence.

In addition to changing the character size and/or the white space around characters, this sequence enacts the following:

- Resets the left and right margins to the printable limits.
- Resets the line home and line end positions to the printable limits. (Refer to the Page Format Select [PFS] sequence on page 54.)
- The current horizontal tabs remain as set.
- Can force the printer into plot mode when Print Mode is set to Disable with the control panel.

Ps selects the horizontal pitch (characters per inch).

Ps	Horizontal Pitch (dpi)
0	Current font pitch
1	10 characters per inch
2	12 character per inch
3	13.3 characters per inch
4	16.7 characters per inch
5	5 character per inch (normal width characters)
6	6 character per inch
8	8.25 characters per inch
9	15 character per inch

Vertical Format

Vertical format consists of two control codes that program the printer to make fast vertical paper movements (slewing) during print jobs. Vertical formatting increases printer efficiency and reduces printing time for repetitive printing jobs.

Vertical channels in the form are defined by downloading the Vertical Format Unit (VFU) from the host to the printer. Subsequent data is then printed on the form at the specified channel. These functions are achieved by using control sequences.

Two control sequences, Load VFU and End VFU, are used to enact the VFU load procedure. Besides loading the VFU, top-of-form is also defined. Top-of-form is determined by the actual paper position when the load VFU command is sent to the printer; therefore, be sure to align the paper at the desired top-of-form *before sending the LOAD VFU command*.

An example showing several VFU commands and the resulting output is provided on page 229.

NOTE: In addition to using VFU commands, you may also ensure faster text printing by selecting an appropriate font and character size setting with DECATFF, SGR instead of the SHS command. The SHS command can force the printer into plot mode. If the page contains a dense concentration of text (many text lines and many characters per line), the SHS command will cause the DEC LG Emulation to pause a few seconds between pages.

Load Vertical Format Unit (VFU)

ASCII Code ESC [< 1 h

Hex Code 1B 5B 3C 31 68

Dec Code 27 91 60 49 104

Purpose Downloads the VFU from the host to the printer.

Discussion All data following the begin load sequence is placed in VFU memory except ASCII control codes. Any command entered during load VFU is ignored except the End Load sequence.

All data must be in the VFU load format. If an error occurs during the load, the load is cancelled. If a load overruns the maximum forms length, the load is cancelled and any remaining VFU data is printed. Cancelled loads default to the current form length setting (as set from the control panel or with the DECSLPP escape sequence).

VFU load format consists of 2 bytes (one byte pair) for each line on the page. The structure of each byte follows:

Table 10 Byte 1 Structure (First Character of Pair)

Bits: 7	6	5	4	3	2	1	0
Value: X	1	C6	C5	C4	C3	C2	C1

Table 11 Byte 2 Structure (Second Character of Pair)

Bits: 7	6	5	4	3	2	1	0
Value: X	1	C12	C11	C10	C9	C8	C7

The variables in the two bytes are defined as follows:

C1 - C12 represent channels 1 through 12 with binary 1s and 0s.

C1 identifies the top-of-form (TOF).

C12 identifies the bottom-of-form (BOF).

Bit 7 for each byte is not used. Bit 6 for each byte is always 1.

NOTE: An example showing several VFU commands and the resulting output is provided on page 229.

End Load (VFU)

ASCII Code ESC [< 1 l

Hex Code 1B 5B 3C 31 6C

Dec Code 27 91 60 49 108

Purpose Ends the Vertical Format Unit load.

Discussion When all VFUs are loaded, enact End Load VFU and the form length set is complete.

NOTE: Load VFU is a long control string format. Make sure that you do not send a CR, LF, or CR+LF in the middle of the VFU data. To avoid having to send a Carriage Return (CR) while entering the Load VFU command, you may wish to set a wide command line for your terminal device.

For example: for VMS, you may increase the command line width for the terminal device used to communicate with the printer to 132 characters, via the command **\$set term/width=132**.

An example showing several VFU commands and the resulting output is provided on page 229.

Channel Command

ASCII Code ESC [p1 & y

Hex Code 1B 5B p1 26 79

Dec Code 27 91 p1 38 121

Purpose The channel commands control paper motion.

P1 consists of three digits: nnn. When the first n equals 9, reverse paper motion occurs. If the first n equals any value other than 0 or 9, the entire sequence is ignored. Table 12 gives the values of nnn for each channel.

Table 12 Channel Values			
p1 nnn	Move Forward to Channel	nnn	Move Backward to Channel
000	1	900	1
001	2	901	
002	3	902	
003	4	903	
004	5	904	
005	6	905	
006	7	906	
007	8	907	
008	9	908	
009	10	909	
010	11	910	
011	12	911	
* Selecting any other channel than those in this table results in a default to channel 12.			

Beware of the following conditions when the selected channel is in the forward direction:

- If you try to print text at a channel not previously defined, the text prints at channel 12 (BOF).
- If you try to print text at a channel not previously defined and channel 12 is also undefined, text prints at the next line.
- If a VFU table is not loaded and channel commands are sent to it, a line feed occurs then the text prints.

- If you load a VFU table with more than one TOF and/or more than one BOF already defined, the load is terminated and a warning message is displayed on the front panel.

Beware of the following conditions when the selected channel is in the reverse direction:

- If you try to print text at a channel not previously defined, a reverse line feed occurs then the text prints.
- If you try to print text at a channel not previously defined and channel 12 is also undefined, a reverse line feed occurs then the text prints.
- If a VFU table is not loaded and channel commands are sent to it, a reverse line feed occurs then the text prints.
- If you load a VFU table with more than one TOF and/or more than one BOF already defined, the load is terminated and an error code is displayed on the front panel.

Forms

A form contains data. This data is a sequence of self-contained commands and text that can occupy one or more pages of the form. The data form can be downloaded then stored in printer memory for later use. The status report lists the form IDs loaded in the printer.

Once a form is downloaded, it is selectable. Stored data is merged with the fill-in data stream, and the merged data is printed as a completed form. When selected, the printed form can be printed repeatedly with different sets of fill-in data.

Fill-in data is a sequence of commands and text, usually variable and not repeated data, used to fill in the empty fields of a form. Each fill-in data field is terminated with a switch character, as explained in the following section. The fill-in data for the last field of a page must terminate with a switch character unless it is the last page of a form. In this case, use the Terminate Form sequence.

Forms and fill-in data conform to the following:

- Forms cannot be nested.
- Up to 32 forms can be loaded into the printer, subject to available memory.
- Form size must not exceed 64K bytes.
- Each form page must terminate with FF (0/12) and have at least one field.
- Do not use a form-feed character for fill-in data.

The following sections describe how to load a form into memory, select the form for printing, terminate form generation, and delete the form from storage. Appendix D provides an example of commands and output for generating a form, starting on page 225.

Loading Forms Sequence (DECLFM)

ASCII Code DCS P1 ; P2 & p RECORD ST

Hex Code 90 P1 3B P2 26 70 RECORD 9C

Dec Code 144 P1 59 P2 38 112 RECORD 156

Purpose Allows you to load forms into printer memory.

Discussion The Pn parameters define the format of the form as well as which forms to delete. Forms can be loaded at any time except during another download operation, or while a form is printing. Once loaded, forms are selectable until:

- New forms are loaded with the P2 = 3 (replace all forms) command

- Another form with the same number is loaded (replacing the old form)
- System power is turned off (all loaded forms are lost) P1 and P2 can be defined as follows:
- P1 is the form file indicator that specifies the form file format used in the command string. The value must be 0 and the file must be in the form file format, otherwise the entire load form sequence is ignored.

P1	Function
0	DEC LG-series printer form file format
Other	Sequence is ignored

- P2 defines the replacement action: which forms to delete before the new form is loaded. If you choose to replace all forms, note that the forms are deleted even if the new form is not successfully loaded.

P2	Function
0/Missing	Replace the named form
3	Replace all forms

The form record includes a form header that defines form parameters and size, and the form data string. It is constructed as follows:

- <ID length><Form ID><CNTL encoding character>
- <Form data switch character><Form length>
- <Form data string>

These form record fields are described in detail below:

- ID length is a two-digit number (01 - 99) that defines the length of the form ID.
- Form ID is a string of 1 - 99 printable characters. IDs exceeding 10 characters are truncated.
- The CNTL encoding character

The CNTL encoding character indicates the start of control- character encoding. The character is always in the 2/0 through 7/ 14 range and is followed by a two-digit hexadecimal number equivalent to the ASCII value of the control character to be encoded.

Every control character must be entered in its hexadecimal format and preceded by the control character. Do not embed a control character (0/0 through 1/15) in the form string. The following control characters and their hexadecimal values are allowable:

Control Char.	Hex Code	Control Char.	Hex Code
BEL	07	ESC	1B
BS	08	IND	84
HT	09	NEL	85
LF	0A	HTS	86
VT	0B	VTS	87
FF	0C	PLD	8A
CR	0D	PLU	8B
SO	0E	RI	8C
SI	0F	SS2	8E
CAN	18	SS3	8F
SUB	1A	CSI	9B

All printable characters (except control characters) are encoded in the same manner. For example, to embed the control sequence: ESC [100 ` , (CSI 100 `) into the form, replace ESC with the control-character encoding character (^) and the hexadecimal value for ESC (1B). The form's sequence is ^1B[100`.

- Form Data Switch Character designates the insertion of the form's fill-in data. The character, considered a field indicator character, is always in a range from 2/0 through 7/14. The form-data switch character must be different from the control-character encoding character. The form data switch character is not printable within the form and should not be used in any control sequence in the form.
- Form length is a five-digit number (00001 through 65,535) that defines the length of the string to follow. The string count includes all characters other than uncoded control characters (0/0 through 1/15).
- Form Data String is the constant portion of the form: the data. Form data is a string of text and command sequences with encoded control characters. Terminate the string with an ST command. Uncoded control characters (other than ESC), act as formatting characters for editors. Though you can embed them in the form data string, they are not part of the form.

For more information, refer to Appendix D.

Form Types

A form can be printed in Print mode, in Plot mode, or in a combination of Print and Plot mode.

- In Plot mode, all positioning should be fully specified by the LG positioning commands. The entire form is plotted if the following conditions exist:

Contains any graphics (block characters, bar codes, vectors, logos)

The pitch of the font does not exist in print mode

The form uses justified text

- In Print mode, all positioning is controlled by the CR, LF, and tabs control characters. The entire form is printed if:

It contains justified text and no font changes occur within a line

It does not violate any other conditions of Print mode

Start Forms Sequence (DECIFM)

ASCII Code DCS P1 & r FORM NAME ST

Hex Code 90 P1 26 72 FORM NAME 9C

Dec Code 144 P1 38 114 FORM NAME 156

Purpose Selects any form loaded in RAM.

Discussion P1 is the Select Form Switch character. With this sequence, a form loaded in RAM is selectable for printing. When you select the form, the printer enters Form mode. The variable fill-in data is merged and printed with the form data. When the printer encounters an FF character in the form data portion of a multiple page form, it advances to the next page and continues merging with the fill-in data that follows. If there is more than one set of fill-in data, the same form constant data is merged with the new fill-in data to create additional forms.

The select form switch character always ranges from 2/0 through 7/14 decimal and designates the print source to switch back to form data (to the character after the form data switch character). The character does not have to be the same as the form data switch character; however, it is not printable within the fill-in data string.

The form name is the first ten characters of the loaded form's ID (or the full form ID if it is ten characters or less in length). If no such form exists, an error message displays and the fill-in data is printed as text data.

Note that the text and command strings corresponding to the last field of a multi-page form page must terminate with a switch character. However, the last field in the last page of a form must terminate with the Stop Form sequence and not with the switch character. To exit Form mode, enter a Terminate sequence.

Many special conditions might affect the printer output or performance in its various uses. See Forms Considerations, page 48, for further information regarding these conditions.

Terminate Forms Sequence (DECTFM)

ASCII Code ESC # SP 1

Hex Code 1B 23 20 31

Dec Code 27 35 32 49

Purpose Terminates the printing of a form.

Discussion If no form is selected, this sequence is ignored.

Many special conditions might affect the printer output or performance in its various uses. See Forms Considerations, page 48 for further information regarding these conditions.

Delete Forms Sequence (DECDFM)

ASCII Code DCS Ps & q FORMS ID ST

Hex Code 90 Ps 26 71 FORMS ID 9C

Dec Code 144 Ps 38 113 FORMS ID 156

Purpose Deletes forms from printer memory.

Discussion Ps selects the forms to be deleted. The Form ID string identifies the forms to be deleted. If more than one Form ID is listed, separate them with colons. Form IDs with more than ten characters are ignored.

Ps	Function
0	Delete forms with the same name
3	Delete all stored forms

If you try to delete forms, logos, or fonts while they are printing, the printer will ignore the delete command.

Many special conditions might affect the printer output or performance in its various uses. See Forms Considerations, page 48 for further information regarding these conditions.

Forms Considerations

The following commands are not to be included in form data or fill-in data:

- Load a form, logo, or font
- Delete a form, logo, or font
- Invoke a LG sequence
- Invokes an ESCc (RIS) sequence. This will exit you from the Form mode.

Be aware of the following conditions, which can affect the printer's output/ performance in Forms mode:

- To minimize paper movement, print all text together and print all graphics together. Most importantly, print all of the same density material together.
- Encoded Escape sequences cannot start in the form and continue in the fill-in data, nor can the reverse occur.
- Changes made to the font, cursor position, density, or mode are not restored after you terminate a Form sequence.
- Block characters used in a form must begin and end on the same page. Form data switch characters and select form sequence switch characters are not printable as block characters unless they are encoded.
- Since mode settings, fonts, and spacing parameters can be changed between the time the form is loaded and the item is selected, the environment of the form (PUM or SSU) should be established in the form data.
- If ESC, CAN, or SUB is embedded in the form string, it will terminate form loading and the form will be discarded. Encoding DCS, RIS, CAN, or SUB in a form string will also stop form loading.

- If the form length in the header does not agree with the length of the form string received, the form is discarded.
- If the form is not terminated by a form feed (0/12), and does not contain at least one form-switch character, a form-switch character and an 0/12 are added at the end of the form.
- In general, the number of switch characters in the form data should be one more than the number of switch characters in the fill-in data.

When using bar codes, note the following:

- When using bar codes as part of the form data, make sure that the control character encoding character in the bar code differs from the control character encoding character and the switch character in the Loading Form sequence.
- When using bar codes as part of the fill-in data, make sure that the control character encoding character of the bar code differs from the switch character in the Select Form sequence.
- Bar codes must start and end on the same page of a form.

Request Forms Status (DECFMSR)

ASCII Code	CSI & ~
Hex Code	9B 26 7E
Dec Code	155 38 126
Purpose	Requests a status report of the forms available for printing.
Discussion	Invoke this request if you need to know what forms are available for printing.

Form Status Report (DECRFMS)

ASCII Code	DCS & s FORM STRING ST
Hex Code	90 26 73 FORM STRING 9C
Dec Code	144 38 115 FORM STRING 156
Purpose	Printer response to a DECFMSR sequence.
Discussion	The status string contains a list of all valid forms loaded in the printer. Each form name starts on a new line and is separated by commas.

Logos

A logo is a graphic image stored in the printer. Once a logo is downloaded, it can be printed repeatedly by referring to its identifying number. Up to 16 logos can reside in the printer, with a maximum size of 65,535 bytes per logo. The following subsections explain various ways in which to utilize the logo feature. For an example of commands and output for creating a logo, see page 224.

Loading Logos Sequence (DECLLG)

ASCII Code	DCS P1 ; P2 & t RECORD ST
Hex Code	90 P1 3B P2 26 74 RECORD 9C
Dec Code	144 P1 59 P2 38 116 RECORD 156
Purpose	Loads logos into printer memory.

Discussion Pn parameters select the format and the logos to be deleted before loading this logo.

- P1 specifies the logo file indicator that chooses the logo file format used in the command string. The indicator number must be 0 and the file must be in the DEC LG-series printer logo file format. If not, the entire load logo set is ignored. Default: P1 = 0.
- P2 lists the logos to be deleted.

Ps	Vertical Pitch
0	Delete all logos
Others	Delete any logo with the same Logo ID as this one

Logos can be loaded at any time except during another download operation and during a form printing operation. When loaded, they are available for selection until:

- A logo with the same number is loaded (the new logo, though the same number, will replace the old).
- System power is turned off (all loaded logos are lost).

The logo record includes all data after the final character (t) and up to the string terminator, as well as the logo header portion and the row data strings portion. The logo header contents identify the logo and the size (number of characters) of the row data string. The logo record variables include:

- ID Length is a one digit number (1 through 4) that defines the length of the logo ID.
- Logo ID is a string of one to four numerals that identify the logo.
- Comment Length is a one digit number (0 through 7) that defines the length of the comment field. The comment field provides additional logo information, and appears in the status report; however, it is not part of the logo identification. Also listed on the status report are the IDs and the comment field of the logos available in the printer.
- Logo Length is a five digit number (00001 through 65,535), that defines the length of the logo record. The logo length includes all characters other than C0 control characters (0/0 through 1/15).

The row data string consists of one or more row records describing the format of the logo image. Within this string is a row record, which is a sequence of parameters that define the height and length of the black and white segments in mils. A row sequence has the following format: r;s; n1;n2;...\ where the following is true:

r = height of the segment in mils

s = row starting color. Defines whether the row starts with a white (0) or a black (1) segment. Each subsequent segment will be the opposite color from the previous segment.

n1; n2 = length of the segments in mils.

\ = row terminator

Note that none of the above parameters should exceed 65,535 in value. Editing control characters such as CR and LF, can be embedded within the logo record.

Select Logo Sequence (DECILG)

ASCII Code CSI Pn & }

Hex Code 9B Pn 26 7D

Dec Code 155 Pn 38 125

Purpose Prints selected logos present in printer memory.

Discussion Pn defines the ID of the selected logo. If no logo exists for that ID, the sequence is ignored. Logos are printed in the current page orientation and graphics density. Before you select a logo sequence, set the logo density with DECSGD and the orientation. When the logo sequence is complete, reset the density and set cursor position. At the end of a Select Logo sequence, the cursor remains in the starting position.

If the height of the segments is not an integral multiple of the density selected, the size of the printed logo might change due to accumulated round-off errors. To maintain a uniform size, print logos only in the densities for which they were designed.

Deleting Logos Sequence (DECDLG)

ASCII Code CSI P1 ; P2 ; ... ; Pn & |

Hex Code 9B P1 3B P2 3B 2E2E2E 3B PN267C

Dec Code 155 P1 59 P2 59 464646 59 PN38124

Purpose Deletes logos from printer memory.

Discussion P1 defines the logos to be deleted:

P1	Function
0	Delete all logos whose IDs are listed
3	Delete all stored logos

When P1 = 0, parameters P2 through P16 make up the ID of the logos to be deleted. You can select up to 16 logo IDs to delete. Deleting a logo within a form is not allowed.

Request Logo Status (DECRLGS)

ASCII Code CSI ' p

Hex Code 1B 27 70

Dec Code 27 39 112

Purpose Gives a status report of the logos available for printing.

Discussion Invoke this request if you need to know what logos are available for printing.

Logo Status Report (DECLGSR)

ASCII Code DCS & w LOGO STRING ST

Hex Code 90 26 77 LOGO STRING 9C

Dec Code 144 38 119 LOGO STRING 156

Purpose Reports the logo status in response to the DECRLGS sequence.

Discussion The logo string contains a list of all the valid logos loaded in the printer and their comment strings. Each logo number and comment start on a new line, separated by commas. Several examples of logo IDs and comment strings are shown in the table below:

Logo#	Comment
1	Square
3	Rectangle
12	Rhombus

Page Print Area and Margins

The DEC LG Emulation has no print area limitations; however, smaller page areas can be selected by using the Page Format Select (PFS) sequence.

Figure 2 shows the two types of page orientation: portrait and landscape, for normal and extended page formats. If you use the default font (10 cpi, 6 lpi), the print areas are:

Normal Page Format:

Portrait font: 59 lines per page
72 characters per line

Landscape font: 38 lines per page
100 character per line

Extended page Format:

66 lines per page
132 character per line

79 lines per page
110 character per line

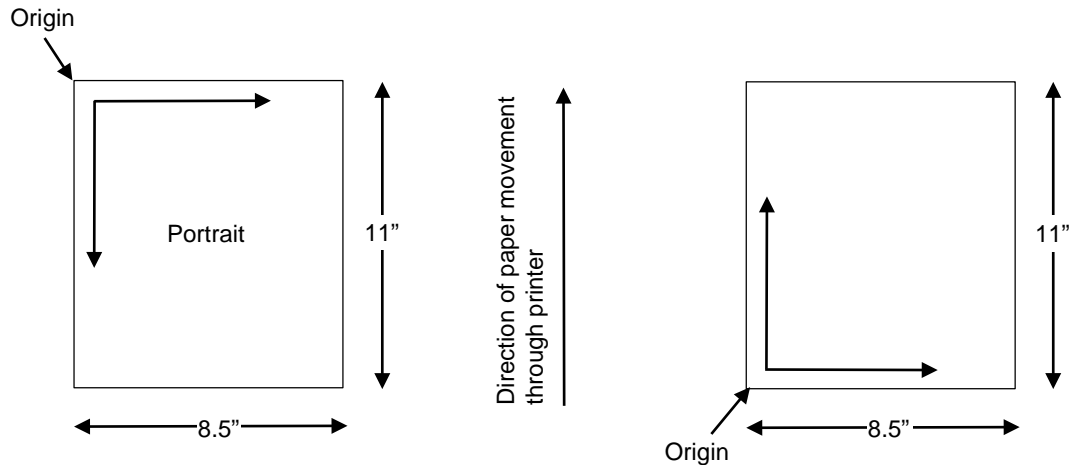

(a) Normal Page Format (8.5 x 11 Inches)

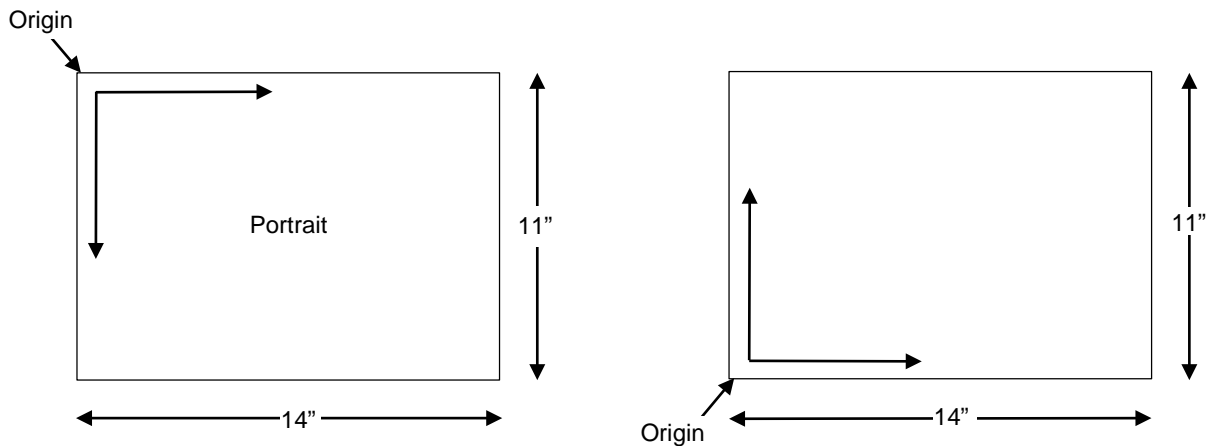

(b) Extended Page Format (14 x 11 Inches)

Figure 2 Page Printing Orientations

In portrait mode, text or graphics prints horizontally (across the paper loaded in the printer). In landscape mode, text or graphics prints vertically (from bottom to top of the paper loaded in the printer).

Changing the Print Area

You can change the print area two ways:

1. Set the printed page to one of the predefined formats using the Page Format Select (PFS) sequence (see page 54). PFS permits you to set page format with one command.
2. Change the page margins and the number of lines per page with these sequences:
 - a. Set Lines Per Physical Page (DECSLPP)
 - b. Set Top and Bottom Margins (DECSTBM)
 - c. Set Left and Right Margins (DECSLRM)

Page Format Select (PFS)

ASCII Code ESC [Ps SP J

Hex Code 1B 5B Ps 20 4A

Dec Code 27 91 Ps 32 74

Purpose Selects a page format from a list of predefined formats.

Discussion Ps selects one of 12 page formats. Two kinds of format are available: normal and extended.

In the normal page format, the page home line is 0.5 inches below the top margin, and the page end line is 0.833 (5/6) inches above the bottom margin. Normal page formats are:

Ps	Format
0	Portrait text communication (default)
1	Landscape text communication
2	Portrait A4 (210 mm x 297 mm)
3	Landscape A4
4	Portrait North American (NA) letter
5	Landscape North American letter

In the extended page format, the page home line is at the top margin, and the page end line is at the bottom margin. Extended page formats are:

Ps	Format
6	6 lines per inch (current default)
7	8 lines per inch
?20	Portrait North American LG private
?21	Landscape North American LG private
?22	Portrait A4 LG private
?23	Landscape A4 LG private
?28	Portrait line printer: 11 inches high x 13.2 inches wide
?29	Landscape line printer: 13.2 inches high x 11 inches wide

The line home and line end positions serve as the left and right edges of the printed page for justified text. The line home position is the active position after a carriage return (CR). A carriage return may move the active position forward or backward in order to reach the line home position.

The page home line is the active line after a form feed (FF). The index (IND), next line (NL), and carriage return characters cause a form feed when they pass the page end line. Use the vertical position absolute and relative (VPA and VPR) sequences to move below the page end line. If a line feed passes the page end line, the printer prints the current page and performs a form feed to get to the next page.

Ps parameters 0 through 7 are public (ANSI) parameters: ASCII values 0 through 7. The other six Ps parameters are defined by LG and are called LG private parameters. These always start with the ? (3/15) character. The kind of parameters used affect page format. If you chain commands, do not mix LG private parameters with public parameters.

Table 13 shows the printable area selected with each PFS format. Text area is for justified text.

Table 13 Paper Dimensions Using PFS Formats

Minimum P's	Paper Width	Dimensions Length	Print Width	Area Length	Text Width	Area Length	Default Lines
Normal Page Formats:							
0	8.5	11.0	7.7	10.5	7.2	9.7	55
1	11.0	8.5	10.5	7.7	10.0	6.34	38
2	8.0	11.5	7.7	11.0	7.2	9.83	59
3	11.5	8.0	11.0	7.67	10.5	6.33	4
4	8.5	11.0	8.0	10.5	7.5	9.17	
5	11.0	8.5	10.5	8.0	10.0	6.5	
Extended Page Formats:							
6	8.0	11.0	7.7	11.0	7.2	11.0	66
7	11.0	7.5	11.0	7.33	10.5	7.33	44
?20	8.5	11.0	8.0	10.56	8.0	10.56	63
?21	11.0	8.5	10.0	8.5	9.68	8.0	47
?22	8.0	11.0	7.73	10.88	7.73	10.56	63
?23	10.5	8.0	9.68	7.92	9.68	7.92	47
?28	14.0	11.0	13.2	11.0	13.2	11.0	66
?29	11.0	14.87	11.0	13.2	11.0	13.2	79
* The number of lines available at the initial vertical spacing of 6 lines per inch.							

Table 14 shows the lines per page and the characters per line selected with the normal and extended PFS formats.

Table 14 Lines Per Page and Characters Per Line Using PFS Formats

Ps	Format Description	Lines Per Page in Text Area (Lines Per Inch)				Chars. Per Line in Text Area (Characters Per Inch)			
		8	6	4	3	10	12	15	6
Normal Page Formats:									
0	Portrait text comm.	73	59	36	27	72	86	108	43
1	Landscape text comm.	50	38	25	19	100	120	115	60
2	Portrait A4	79	59	39	29	72	86	108	43
3	Landscape A4	50	38	25	19	105	126	157	63
4	Portrait NA letter	73	55	36	27	75	90	112	45
5	Landscape NA letter	52	33	26	19	100	120	150	60
Extended Page Formats:									
6	Portrait extended A4	88	66	44	33	72	86	108	43
7	Landscape A4 format	58	44	29	22	105	126	157.5	63
?20	Portrait NA LG	85	63	36	27	80	96	120	48
?21	Landscape NA LG	63	47	26	19	100	116	150	60
?22	Portrait A4 Private LG	84	63	42	31	73	87	109	43
?23	Landscape A4 Private LG	63	47	31	23	96	116	145	79
?28	Portrait line printer	88	66	44	33	132	158	198	79
?29	Landscape line printer	105	79	52	39	110	132	165	66

Table 15 shows the printable area extending beyond the text area when working in normal and extended PFS formats.

Table 15 Printable Area Extending Beyond Text Area in PFS Formats

Ps	Format Description	Lines Per Page in Text Area (Lines Per Inch)				Chars. Per Line in Text Area (Characters Per Inch)			
		8	6	4	3	10	12	15	6
Normal Page Formats:									
0	Portrait text comm.	4/6	3/5	2/3	1/2	5/2	6/2	7/3	3/0
1	Landscape text comm.	4/6	3/5	2/3	1/2	5/2	6/2	7/3	3/0
2	Portrait A4	4/6	3/5	2/3	1/2	5/2	6/2	7/3	3/0
3	Landscape A4	4/6	3/5	2/3	1/2	5/2	6/2	7/3	3/0
4	Portrait NA letter	4/6	3/5	2/3	1/2	5/2	6/2	7/3	3/0
5	Landscape NA letter	4/6	3/5	2/3	1/2	5/2	6/2	7/3	3/0
Extended Page Formats:									
6	Portrait extended A4	4/6	3/5	2/3	1/2	5/2	6/2	7/3	3/0
7	Landscape A4 format	4/6	3/5	2/3	1/2	5/2	6/2	7/3	3/0
?20	Portrait NA LG	0/0	0/0	0/0	0/0	0/0	0/0	0/0	0/0
?21	Landscape NA LG	0/0	0/0	0/0	0/0	0/0	0/0	0/0	0/0
?22	Portrait A4 Private LG	0/0	0/0	0/0	0/0	0/0	0/0	0/0	0/0
?23	Landscape A4 Private LG	0/0	0/0	0/0	0/0	0/0	0/0	0/0	0/0
?28	Portrait the printer	0/0	0/0	0/0	0/0	0/0	0/0	0/0	0/0
?29	Landscape line printer	0/0	0/0	0/0	0/0	0/0	0/0	0/0	0/0

NOTE: After a power-up or reset sequence, no page format is selected. Reset the printer with the Soft Terminal Reset (DECSTR) or the Reset to Initial State (RIS) sequence.

Backward Compatibility

The page formats described in this section are compatible with previous LG printers. That is, the line home position is the first printable position on the left of the page, and the page home line is the top line on the page.

Likewise, the private PFS values, ?20 through ?29, set the margins, the line home position, and the page home line to the edge of the printable area, for compatibility with previous LG printers. The PFS values depend upon the values in effect for character and line spacing.

Set Lines Per Physical Page (DECSLPP)

ASCII Code ESC [Pn t

Hex Code 1B 5B Pn 74

Dec Code 27 91 Pn 116

Purpose Defines form length.

Discussion A form's length equals the maximum distance the paper moves when a form feed command is issued. Maximum form length is 33 inches.

DECSLPP sets the top margin to 1 and the bottom margin to the form length. Form length limits the range of possible settings for the Set Top and Bottom Margins (DECSTBM) sequence.

Pn sets the form length, subject to the limits discussed above. If Pn is 0 or is greater than the maximum size for the paper and origin, the form length will automatically be set to the maximum for the paper and origin. Units of measurement are character cells, decipoints, or pixels. Select the unit by using the Position Unit Mode (PUM) and Select Size Unit (SSU) sequences. If you use character cells, the height of each cell equals the current line height setting. You can change line height by changing the vertical spacing.

Initial value: Pn = 0. If a Pn value is not set, the form length is set to 66 lines.

Other control sequences are specified in Forms, page 44.

Set Top and Bottom Margins (DECSTBM)

ASCII Code ESC [Pn1 ; Pn2 r

Hex Code 1B 5B Pn1 3B Pn2 72

Dec Code 27 91 Pn1 59 Pn2 114

Purpose Sets the top and bottom margins, and the page home line. These settings are relative to the current origin point for page coordinates. (Refer to Page Format Select (PFS), page 54.)

Discussion Pn1 sets the top margin and the page home line. Pn2 sets the bottom margin. If the first parameter is greater than the second parameter, the printer will ignore the sequence. The unit of measurement can be character cells, decipoints, or pixels. Select the unit by using the Position Unit Mode (PUM) and Select Size Unit (SSU) sequences. If you use character cells, the height of each cell equals the current line height setting. Change line height by changing the vertical spacing.

The top vertical margin defines the first printable line on a page. The bottom vertical margin defines the last printable line. These are called hard margins because you cannot print outside the area defined by the margins. The page home line is the position of the first printable line on the page after a form feed (FF).

Margins settings go into effect as soon as they are received. The printer will set the margins where specified, except in the following cases:

- If Pn1 = 0 or is omitted, the top margin is unchanged.
- If Pn2 = 0 or is omitted, the bottom margin is unchanged.
- If Pn2 is greater than the form length, the bottom margin is set at the bottom of the form.
- If the active position is less than the new top margin, the active position is set to the new top margin. If the active line is greater than the new bottom margin, the next printable character causes a form feed (FF).

- If the sequence sets the top margin below the bottom margin, the command is ignored.
- The printer does not permit any part of the character box to be greater than the bottom margin line or less than the top margin line.

If the form length is changed, the printer sets the top margin to line 1 and the bottom margin to the form length.

Set Left and Right Margins (DECSLRM)

ASCII Code ESC [Pn1 ; Pn2 s

Hex Code 1B 5B Pn1 3B Pn2 73

Dec Code 27 91 Pn1 59 Pn2 115

Purpose Sets the left and right margins.

Discussion Pn1 sets the left margin and the line home position. Pn2 sets the right margin. If the first parameter is greater than the second parameter, the printer will ignore the sequence. The unit of measurement can be character cells, decipoints, or pixels. The maximum allowable value of the Pn1 parameter is always one less than the Pn2 parameter.

The left horizontal margin defines the first printable position on a line. The right horizontal margin defines the last printable position on a line. These are called hard margins because you cannot print outside the area defined by the margins, except under two conditions:

1. Using the Drawing Vectors (DECVEC) sequence, you can draw lines outside the margins.
2. If you justify text, but the spacing between words is less than the minimum specified width of the space character, the text will print unjustified and will exceed the right margin.

Margins settings go into effect as soon as they are received. The printer will set the margins where specified, except in the following cases:

- If Pn1 = 0 or is omitted, the left margin is unchanged.
- If Pn2 = 0 or is omitted, the right margin is unchanged.
- If Pn2 is greater than the printable width, the right margin is set to the right printable limit.
- If the sequence sets the left margin to the right of the right margin, the command is ignored.
- If the active position is less than the new left margin, the active position is set to the new left margin.
- If Autowrap is enabled and the active position is greater than the specified right margin, the next printable character causes a carriage return/line feed before the next character is printed. If Autowrap is disabled (truncated), the characters that follow this command are ignored until the cursor is returned to the printable area.
- When character pitch is changed but the same physical margins are desired, reset the margins using this escape sequence before sending data. Changing horizontal pitch resets the left and right margins to their printable limits (column 1 and the furthest right position, respectively).

Active Column and Active Line (Cursor Motion)

This section describes cursor positioning command sequences. Line printers do not have a cursor like the blinking place-marker on most computer screens. The cursor position on a line printer is the space where the next character will print. In this manual, cursor refers to the currently active print position. Its location is the intersection of the active column and active line. Horizontal and vertical positioning command sequences allow you to move the active position anywhere on the logical page.

You can also specify either absolute or relative motion. Absolute motion specifies the distance to move from a specific point on the logical page. Relative motion specifies the distance to move from the currently active print position.

The Partial Line Up (PLU) and Partial Line Down (PLD) command sequences set half line increments for superscripting and subscripting.

NOTE: Next Line (NEL), Reverse Index (RI), and Index (IND) control characters also move the active position. (Refer to Table 2.)

Forward Index (IND)

ASCII Code ESC D

Hex Code 1B 44

Dec Code 27 68

Purpose Causes the active position to move to the following line's corresponding horizontal character position.

Discussion Pn specifies the active position.

Attempts to move the cursor below the bottom margin cause the cursor to move to the corresponding horizontal position on the first printable line of the next form.

In 8-bit mode, the Forward Index 8-bit control code can be used for this function (refer to Control Code Types, page 17).

Reverse Index (RI)

ASCII Code ESC M

Hex Code 1B 4D

Dec Code 27 77

Purpose Causes the active position to move to the corresponding character position of the preceding line.

Discussion Pn specifies the active position. The Reverse Index command causes the active position to stop at the top margin.

In 8-bit mode, the Reverse Index 8-bit control code can be used for this function (refer to Control Code Types, page 17).

Next Line (NEL)

ASCII Code ESC E

Hex Code 1B 45

Dec Code 27 69

Purpose Causes the active position to move to the first character position on the following line.

Discussion If you try to move the cursor past the bottom margin, the cursor moves to the first character position on the first printable line of the next form.

In 8-bit mode, the Next Line 8-bit control code can be used for this function.

Horizontal Position Absolute (HPA)

ASCII Code ESC [Pn `

Hex Code 1B 5B Pn 60

Dec Code 27 91 Pn 96

Purpose Selects the active column on the active line.

Discussion Pn value specifies the new active column. Default value: Pn = 1.

If you try to move the active column to the right of the last position on the line, the active position stops at the last position on the line.

Horizontal Position Relative (HPR)

ASCII Code ESC [Pn a

Hex Code 1B 5B Pn 61

Dec Code 27 91 Pn 97

Purpose Moves the active column by adding the value Pn to the currently active column.

Discussion Pn is the value added to the currently active column.

Default value: Pn = 1.

If you try to move the active column to the right of the last position on the line, the active position stops at the last position on the line.

Horizontal Position Backward (HPB)

ASCII Code ESC [Pn j

Hex Code 1B 5B Pn 6A

Dec Code 27 91 Pn 106

Purpose Moves the active column backward by subtracting the value Pn from the currently active column.

Discussion Pn is the value subtracted from the currently active column.

Default value: Pn = 1.

If you try to move the active column to the left of the first position on a line, the active position stops at the first position on that line.

Vertical Position Absolute (VPA)

ASCII Code	ESC [Pn d
Hex Code	1B 5B Pn 64
Dec Code	27 91 Pn 100
Purpose	Causes the active position to be moved to the corresponding horizontal position at vertical position Pn.
Discussion	<p>Pn is the new active line at the currently active column. Default value: Pn = 1.</p> <p>If Pn is less than the current active line, the active line moves backwards on the current page. If you try to move the active line below the bottom line, the active position stops at the bottom.</p>

Vertical Position Relative (VPR)

ASCII Code	ESC [Pn e
Hex Code	1B 5B Pn 65
Dec Code	27 91 Pn 101
Purpose	Moves the active line to the corresponding horizontal position by adding Pn to the value of the currently active line.
Discussion	<p>Pn is the value added to the currently active line. Default value: Pn = 1.</p> <p>If you try to move the active line below the bottom line, the active position stops at the bottom line.</p>

Vertical Position Backward (VPB)

ASCII Code	ESC [Pn k	Hex Code	1B 5B Pn 6B	Dec Code	27 91 Pn 107
Purpose	Moves the active position to the corresponding column at the preceding vertical position set by the Pn value.				
Discussion	<p>Pn is the value subtracted from the currently active line. Default value: Pn = 1.</p> <p>If you try to move the active line above the top line, the active position stops at the top line.</p>				

Cursor Up (CUU)

ASCII Code	ESC [Pn A
Hex Code	1B 5B Pn 41
Dec Code	27 91 Pn 65
Purpose	Causes the active position to move to the corresponding column at the preceding vertical position set by the Pn value.
Discussion	<p>If you try to move the active position above the top line, the active position stops at the top line.</p> <p>Pn is the number of lines that the active line moves up at the current active column. Default value: Pn = 1.</p>

Partial Line Up (PLU) - Superscripting

ASCII Code ESC L

Hex Code 1B 4C

Dec Code 27 76

Purpose Print superscripted characters.

Discussion This sequence moves the active position up a distance equal to 1/12". The Partial Line Down (PLD) sequence returns the active position to the previous baseline.

The printer prints superscripted characters that go over the top page margin without disrupting the baseline of the superscripted characters. If PLU occurs while the active position is over the top margin, it has no effect; however, other active line-affecting control functions still produce their distinctive effect.

For example, if the active line is over the top margin, a carriage return <CR> places the active line at the top of the margin and characters are imaged as superscript until disabled. If the active line is below the bottom margin, a carriage return <CR> performs a form feed and characters are imaged as superscripts until disabled.

Partial Line Down (PLD) - Subscripting

ASCII Code ESC K

Hex Code 1B 4B

Dec Code 27 75

Purpose Print subscripted characters.

Discussion This sequence moves the active position down 1/12". The Partial Line Up (PLU) sequence returns the active position to the previous baseline.

The printer prints subscripted characters that go over the bottom page margin. If PLD occurs while the active position is over the bottom margin, it has no effect.

Tab Stops

A tab stop is a predetermined point to which the active position moves when you send the HT and VT tab commands. The active position is where the next character will print. A page can have a maximum of 32 horizontal tabs, and a maximum of 67 vertical tabs.

You can set horizontal and vertical tabs. The printer will ignore tab setting commands for tabs already set. Likewise, the printer will ignore tab clearing commands for tabs already cleared. The current origin of printing is the reference point for tabs.

Set Horizontal Tab Stops (DECSHTS)

ASCII Code ESC [Pn ; ... ; Pn u

Hex Code 1B 5B Pn 3B ... 3B Pn 75

Dec Code 27 91 Pn 59 ... 59 Pn 117

Purpose Pn denotes a horizontal tab stop location.

Discussion DECSHTS allows you to select up to 16 horizontal tab stops at one time. Thirty-two possible horizontal tab stops are available, however, any sequence beyond 16 is ignored. The Pn values can be in any order in the escape sequence.

The unit of measurement can be character cells, decipoints, or pixels. It is selected by using the Position Unit Mode (PUM) and Select Size Unit (SSU) sequences. If you select character cells, the width of each cell equals the current character width setting. Character width is determined by setting the horizontal spacing.

When you assign a new tab stop value, each new tab stop value is inserted into the current tab stop list, starting after the old tab stop with the next lower value. If you assign more than the maximum of 16 new tab settings, the printer discards the old tab stop with the highest value before entering each additional new tab stop. If the new tab stop has the highest value and you have set the maximum allowed number of tab stops, the printer ignores the new tab stop.

If a tab stop is not on the boundary of a character cell, tabbing to that tab stop in print mode forces the printer to the nearest character position.

Horizontal Tab Stops (HTS)

ASCII Code ESC H

Hex Code 1B 48

Dec Code 27 72

Purpose Causes a horizontal tab stop to be set at the current position.

Discussion A horizontal tab stop can also be achieved in 8-bit mode by sending the HTS 8-bit control code.

Set Vertical Tab Stops (DECSVTS)

ASCII Code ESC [Pn ; ... ; Pn v

Hex Code 1B 5B Pn 3B ... 3B Pn 76

Dec Code 27 91 Pn 59 ... 59 Pn 118

Purpose Sets vertical tabs at the rows indicated.

Discussion Pn denotes a vertical tab stop location. Select up to 16 vertical tabs in one sequence. Up to 67 vertical tab stops can be set per page. The default is set to stop at every line.

The unit of measurement can be character cells, decipoints, or pixels. It is selected by using the Position Unit Mode (PUM) and Select Size Unit (SSU) sequences. If you select character cells, the height of each cell equals the current character line-height setting. Character height is determined by setting the vertical spacing.

The printer sets vertical tab stops at positions you select. New tab stop values are added to the current tab stop list, starting with the lowest value to be added. If the number of tab settings exceeds the number of available positions, the printer ignores any tab stop after the 67 values are stored.

Vertical Tab Stops (VTS)

ASCII Code ESC J

Hex Code 1B 4A

Dec Code 27 74

Purpose Causes a vertical tab stop to be set at the current position.

Discussion A vertical tab stop can also be achieved in 8-bit mode by sending the HTS 8-bit control code.

Tab Clear (TBC)

ASCII Code ESC [Ps g

Hex Code 1B 5B Ps 67

Dec Code 27 91 Ps 103

Purpose Clear one or all horizontal or vertical tab stops.

Discussion Ps selects which tab stops to clear.

Ps	Vertical Pitch
0	Clear one horizontal tab stop at the active position
1	Clear one vertical tab stop at the active line
2 or 3	Clear all horizontal tab stops
4	Clear all vertical tab stops

Character Set Selection

To make a character set available for printing, you must designate the set as either G0, G1, G2, or G3. The designated set is then invoked into GL or GR using single or locking shift, and can be used for printing.

National Replacement Characters (NRCs) are created by replacing the relevant characters in the U.S. ASCII character set upon receipt of the appropriate control sequences.

Single and Locking Shifts

A single shift (SS2 or SS3), effects only the first printable GL character following the single shift sequence (refer to Special Parsing Requirements page 24).

A locking shift (LS2, LS3, LS1R, LS2R, or LS3R) persists until another locking shift is invoked.

Table 16 gives the sequences that select the active character sets.

Table 16 Select Active character Sets Using Single and Locking Shifts

Name	Mnemonic	Sequence (Escape/Hex)	Function
Single Shift 2	SS2	ESC N 1BH 4EH	The character that follows SS2 selects from the G2 character set.
Single Shift 3	SS3	ESC O 1BH 4FH	The character that follows SS3 selects from the G3 character set.
Locking Shift 0	LS0	<SI> OFH	The G0 character set becomes the active GL character set.
Locking Shift 1	LS1	<SO> OEH	The G1 character set becomes the active GL character set.
Locking Shift 2	LS2	ESC n 1BH 6EH	The G2 character set becomes the active GL character set.
Locking Shift 3	LS3	ESC o 1BH 6FH	The G3 character set becomes the active GL character set.
Locking Shift 1 Right	LS1R	ESC ~ 1BH 7EH	The G1 character set becomes the active GR character set.
Locking Shift 2 Right	LS2R	ESC } 1BH 7DH	The G2 character set becomes the active GR character set.
Locking Shift 3 Right	LS3R	ESC 1BH 7CH	The G3 character set becomes the active GR character set.

Select Character Set Sequences (SCS)

The Select Character Set Sequence (SCS) assigns a character set to the G0, G1, G2, or G3 character set designators. Table 17 gives the sequences that select the available 94-Character Sets. Table 18 gives the sequences that select the available 96-Character Sets.

Table 17 Selecting 94-Character Sets Using Single and Locking Shifts

Character Set	G0	G1	G2	G3
U.S. ASCII	ESC(B	ESC)B	ESC*B	ESC+B
DEC Finnish	ESC(5	ESC)5	ESC*5	ESC+5
French (France)	ESC(R	ESC)R	ESC*R	ESC+R
DEC French Canadian	ESC(9	ESC)9	ESC*9	ESC+9
German	ESC(K	ESC)K	ESC*K	ESC+K
Italian	ESC(Y	ESC)Y	ESC*Y	ESC+Y
JIS Roman	ESC(J	ESC)J	ESC*J	ESC+J
DEC Norwegian/Dutch	ESC(6	ESC)6	ESC*6	ESC+6
Spanish	ESC(Z	ESC)Z	ESC*Z	ESC+Z
DEC Swedish	ESC(7	ESC)7	ESC*7	ESC+7
DEC Great Britain	ESC(A	ESC)A	ESC*A	ESC+A
ISO Norwegian/Danish	ESC('	ESC)'	ESC*'	ESC+'
DEC Dutch	ESC(4	ESC)4	ESC*4	ESC+4
DEC Swiss	ESC(=	ESC)=	ESC*=	ESC+=
DEC Portuguese	ESC(%6	ESC)%6	ESC*%6	ESC+%6
VT100 Graphics	ESC(0	ESC)0	ESC*0	ESC+0
DEC Supplemental	ESC(%5 or ESC(<	ESC)%5 or ESC)<	ESC*%5 or ESC*<	ESC+%5 or ESC+<
DEC Technical	ESC(>	ESC)>	ESC*>	ESC+>
ISO Katakana	ESC(I	ESC)I	ESC*I	ESC+I
7-Bit Hebrew	ESC(%=	ESC)%=	ESC*%=	ESC+%
7-Bit Turkish	ESC(%2	ESC)%2	ESC*%2	ESC+%2
Greek Supplemental	ESC("?	ESC)"?	ESC*"?	ESC+"?
Hebrew Supplemental	ESC("4	ESC)"4	ESC*"4	ESC+"4
Turkish Supplemental	ESC(%0	ESC)%0	ESC*%0	ESC+%0
NOTE: Any other character following the above escape sequences causes the entire sequence to be ignored.				

Table 18 Selecting 96-Character Sets Using Single and Locking Shifts

Character Set	G0	G1	G2	G3
ISO Latin 1		ESC-A	ESC.A	ESC/A
ISO Latin 2		ESC-B	ESC.B	ESC/B
ISO Latin 5		ESC-M	ESC.M	ESC/M
ISO Latin 9		ESC-b	ESC.b	ESC/b
ISO Cyrillic		ESC-L	ESC.L	ESC/L
ISO Greek		ESC-F	ESC.F	ESC/F
ISO Hebrew		ESC-H	ESC.H	ESC/H

NOTE: Any other character following the above escape sequences causes the entire sequence to be ignored.

Assign User Preference Supplemental Set (DECAUPSS)

ASCII Code DCS Ps ! u D...D ST

Hex Code 90 Ps 21 75 *...* 9C

Dec Code 144 Ps 33 117 *...* 156

Purpose Assigns a particular character set to the User Preference Supplemental (UPS) set.

Discussion Assigns several of the ISO and special character sets to the User Preference Supplemental set. Before selecting one of the character sets in Table 19 via the SCS code, you may first assign it to the UPS set using this control code.

Table 19 UPS Character Sets

Character Set	Ps	D...D
DEC Supplemental	0	%5
ISO Latin-1 Supplemental	1	A
ISO Latin-Hebrew Supplemental	1	H
DEC Technical	0	>
ISO Latin-Greek Supplemental	1	F
ISO Latin 9	1	b

NOTE: If values for Ps and D...D are selected other than those in Table 19, this command will be ignored.

Ps Parameter

Ps indicates whether the specified UPS set is a 94-character or a 96- character set:

Ps1	Function
0	94-character set
1	96-character set

D...D Parameter

D...D is a string that contains the character set identifier. See SCS in this chapter for a list of intermediate and final characters. The identifier for the character set in this command is the same as the final character(s) in the identifier listed for the Select Character Set (SCS) sequence (see page 67).

Examples

To assign LG Supplemental as the User Preference Supplemental character set, use the following DECAUPSS command:

```
DCS 0! u %5 ST
```

To assign ISO Latin-1 Supplemental as the User Preference Supplemental set, use the following command:

```
DCS 1! uA ST
```

Product Identification (DA)

ASCII Code ESC [c or ESC [0c

Hex Code 1B 5B 63 1B 5B 30 63

Dec Code 27 91 99 27 91 48 99

Purpose Shows the product identification.

Discussion When the host computer sends a device attributes (DA) sequence, the printer immediately sends an answering sequence that identifies the printer. The printer will answer as follows:

```
DEC LG Emulation Product ID ESC [ ? <45>c 1B 5B 3F 34 35 63
```

Printer Status Requests and Reports

The host computer can send Device Status Requests (DSRs) to the printer, which will then respond with status reports about its operational condition.

The printer will send reports to the host that are brief or extended, and solicited or unsolicited. Unsolicited status reports are sent only when an error occurs and only when unsolicited status reports are specifically enabled.

Unsolicited status reports are sent after the current page prints, and list each error type once. Printer default is unsolicited reports disabled.

NOTE: This option will work properly only if the printer has the serial interface selected, and if the RTS option on the host interface serial menu is set to True (the default). Refer to the Administrator's Manual.

Device Status Requests (DSRs) and Printer Responses

The host computer sends the DSR sequences listed below to request status reports and to enable or disable unsolicited status reports.

Table 20 DSR Sequences

Request Sequence	Printer Response
CSI 0 n or CSI 5 n	Send an extended status report.
CSI 6 n	Send a cursor position report.
CSI ? 1 n	Disables all unsolicited status reports from printer.
CSI ? 2 n	Enable brief, unsolicited status reports and send an extended status report.
CSI ? 3 n	Enable extended, unsolicited status reports and send an extended status report.

NOTE: Unsolicited status reports, when enabled, are sent when any reportable status or error condition occurs. (Unsolicited reports are initially disabled.)

Printer responses to these commands are discussed on the following pages.

Printer Status Reports

The printer sends a Device Status Report (DSR) to the host via the serial line when requested by the host (DSR) or when unsolicited reports have been previously enabled and a reportable status condition has occurred. The host can request a brief or extended status report, as follows:

NOTE: The question mark (?) character occurs only once per DSR sequence.

- Brief, Unsolicited Messages Enabled:

Request Sequence	Printer Response
CSI n1 n	n1 = 3 If a malfunction is detected n1 = 0 After error condition has been corrected or if no malfunction exists.

- Extended, Unsolicited Messages Enabled:

Request Sequence	Printer Response
CSI 0 n	CSI ? 2 0 n After error condition has been corrected or if no malfunction exists
CSI 3 n	CSI ? Pn;...Pn n If a malfunction is detected
Pn = Generic error code (See Table 21.) Pn n = Specific error code (See Table 21.)	

- Cursor Position Report: The unit of measurement can be character cells, decipoints, or pixels. It is selected by using the Position Unit Mode (PUM) and Select Size Unit (SSU) sequences.

Request Sequence	Printer Response
CSI Pn1 ;Pn2 R	pn1 is the active line pn2 is the active column

Values of Pn (up to three digits) are defined in page 71. Printer status codes are reported in pairs: a generic error code first, then a specific error code.

A hardware failure consists of any errors listed in “Self-test error messages” and “Font Checksum Errors found at Initialization.”

1. Communication failures are usually attributed to parity errors, framing errors, or receipt of an erroneous character.
2. Failures designated as events are reset only when an extended report is sent. If set for solicited reports, the events are reset only after the report is requested and reported. If set for unsolicited reports, the report is immediately sent and the event cleared.
3. RIS and DECSTR reset any event not reported.
4. All non-events are not latched, but continuously reflect the current state of the relevant parameter.

Table 21 Printer Status Error Codes

Generic Fault Codes	Specific Number Codes	LCD Message
21	134	Req. Font Deleted
24	125	Off-Line
25		Paper Jam
26		Cover Open
27	206	Paper Out
31		Emul Switch Err
32	216	Paper Fault
36	220	Platen Open
37	222	Bad Font Data
38	229	Ribbon Stall
40	124	Char. Not In Font
41	101	Page Too Complex
41	102	Margins Exceeded
41	105	Page Too Big

Table 21 Printer Status Error Codes

Generic Fault Codes	Specific Number Codes	LCD Message
41	108	Out of Form Mem
42	112	Font Load Fault
43	116	Invalid Params
44	103	Too Many Fonts
44	108	Too Many Forms
44	109	Too Many Logos
47	113	Too Many Errors
48	118	Bad Form Data
48	119	Bad Logo Data
48	140	VFU Seq. Error
48	141	VFU Load Fmt Err
48	142	VFU TOF/BOF Err

Assigning and Selecting Font Files

Each font file stored in the printer includes data for one of the three standard character sets: ASCII, DEC Supplemental, and DEC Technical.

Each font file also includes data for one font, which is part of a type family. You can identify font files by type family ID, font ID, and font file ID. (Refer to Appendix C.)

The type family ID consists of seven characters. The type family IDs for the standard type families used with resident font files are listed below.

Type Family	Identification (ID) String
Data Processing	DBULTN1
Compressed Print	DCMPRESS
Correspondence Plot	DCRRSPL
Correspondence Print	DCRRSPN
Draft Plot	DDRAFT0
High Speed Draft Print	DDRAFT1
LG Near Letter Quality	DLGNRLQ
Low Density Plot	DLODENS
OCR A	ROCRA00
OCR B	ROCRB00

The font ID has 16 characters (no lowercase letters permitted) and describes the seven basic font attributes (including type family) of the resident fonts. Appendix C lists the standard type family, font, and font file IDs for the resident files.

To make a font file available for printing, you must assign a Select Graphic Rendition (SGR) number (page 74) to the file. Then you can select the SGR number for printing.

Default Fonts

When you power up or reset the printer, it selects SGR number 10 for printing and data processing, and SGR number 19 for plotting and LG Near Letter Quality, unless you have selected and saved another default.

Assign Type Family or Font (DECATFF)

ASCII Code DCS Ps1 ; Ps2 } ID String ST

Hex Code 90 Ps1 3B Ps2 7D ID String 9C

Dec Code 144 Ps1 59 Ps2 125 ID String 156

Purpose Assigns an SGR number to a font ID or type family ID.

Discussion The DECATFF sequence assigns a type family ID (seven characters) or a font ID (16 characters) to an SGR number from 10 to 19. The SGR sequence can then select that font for printing (see page 74).

Each font file contains an ID string as part of its font record.

Ps1 Parameter

Ps1 selects which font assignment to perform:

Ps1	Function
0	Same as 1 (default)
1	Assign font ID to SGR number
2	Assign type family ID to SGR number

Ps2 Parameter

Ps2 selects an SGR number (from 10 to 19) for a type family ID or font ID. The following table indicates the default SGR number assignments:

Ps2	Assignment	ID	Font or Type Family
10	Type Family	DBULTN1	Data Processing (print font)
11	Type Family	DCRRSPN	Correspondence Print (print font)
12	Font	ROCRA00	OCR A (print font)
13	Font	ROCRB00	OCR B (print font)
14	Type Family	DCMPRSS	Compressed (print font)
15	Type Family	DDRAFT1	High Speed Draft (print font)
16	Type Family	DLODENS	Low Density Plot (plot font)
17	Type Family	DCRRSPL	Correspondence Plot (plot font)
18	Type Family	DDRAFT0	Draft Plot (plot font)
19	Type Family	DLGNRLQ	LG Near Letter Quality (plot font)

Type Family ID or Font ID String

The type family ID or font ID identifies which font file to assign to the SGR number (Ps2). You must use only uppercase letters for a type family ID or a font ID.

You can assign up to 10 fonts at one time. Font Assignments may occur anywhere in the data stream. You can send an unlimited number of assign- font-number sequences to the printer.

The printer will accept an ID for a font file not currently stored, but if you try to print or plot a character from the missing font file the printer prints a filled-in rectangle instead. If you assign an ID to an SGR number that already has an ID assigned, the new assignment replaces the old one.

Selecting Fonts for Printing (SGR)

ASCII Code CSI Ps m

Hex Code 9B Ps 6D

Dec Code 155 Ps 109

Purpose Selects fonts for printing or plotting.

NOTE: This SGR sequence format is also used to select several character attributes. (Refer to page 76.) You can combine several SGR sequences by separating Ps values with semicolons (;).

Discussion The Ps values range from 10 through 19; each number corresponds to a font or type family used for printing, as defined by the DECATTf command (see page 73, which shows the default assignments for 10 to 19). If you want to print more than 10 fonts or type families on a page, you must reassign other IDs to these SGR numbers.

If you select a specific font, all seven font attributes are already assigned. If you select a type family, you have two choices for the other six font attributes (type size, spacing, etc.): you can use the default values for those attributes or you can change one or more attributes with control sequences. Thus, selecting a type family gives you more options.

You can use the select font sequence anywhere in the data stream. The selected font remains in effect until the printer receives another select font sequence or a Reset to Initial State (RIS) sequence. After a power-up RIS sequence, the printer uses SGR number 10 for print mode and SGR number 19 for plot mode.

If you send an assign type family or font (DECATFF) sequence for the current SGR number, the sequence takes effect immediately. You do not have to select the current SGR number.

If you select an SGR number that does not have a type family ID or a font ID assigned and you try to plot, the filled rectangle will print.

Deleting Fonts from RAM (DECLFF)

ASCII Code DCS 0 ; 1 ; 0 y ST

Hex Code 90 30 3B 31 3B 30 79 9C

Dec Code 144 48 59 49 59 48 121 156

Purpose Deletes fonts from RAM.

Discussion LG printer emulation fonts are in portrait orientation by default. Each time you request a landscape orientation and select a font, the printer creates a rotated font in RAM. The RAM may fill if you create a number of fonts. The following command sequence lets you delete fonts from RAM.

NOTE: This command is also used in the LN03 printer for loading font files. This function is not present in DEC LG-series printers.

Font Status Sequences

Font status sequences help the host computer control and manage font memory. The host sends a request font status sequence, and the printer responds by sending a font status report. The font status report tells the host which fonts are currently available in the printer.

Request Font Status (DECRFS)

ASCII Code CSI Ps ; Ps " {

Hex Code 9B Ps 3B Ps 22 7B

Dec Code 155 Ps 59 Ps 34 123

Purpose The host computer sends this sequence to request a report of the fonts available for printing, the memory bytes available for loading new fonts, or both.

NOTE: This command works only when the printer is connected to the host through the serial interface.

Discussion The Ps parameter selects the type of font status requested:

Ps	Function
0	Send both reports (same as 1 and 2) (default)
1	Send status of fonts
2	Send amount of RAM available for rotating fonts, forms, and logos

Font Status Report (DECFSR)

The printer uses this sequence to report the font status requested by the DECFSR sequence (page 75). There is a separate report for the two types of status requests.

NOTE: This command works only when the printer is connected to the host through the serial interface.

Response to a DECFSR request with a Ps parameter of 1:

ASCII Code DCS 1 " { IDstring ST

Hex Code 90 31 22 7B IDstring 9C

Dec Code 144 49 34 123 IDstring 156

Discussion The ID string includes the type family name, the type family ID in parentheses, a colon (:), then a new line(s) with each font name. A blank line indicates the end of the previous family. For example,

type family name (type family ID):

font file ID;

font file ID;

type family name (type family ID):

font file ID;

Response to a DECFSR request with a Ps parameter of 2:

ASCII Code DCS 2 " nnn ST

Hex Code 90 32 22 nnn 9C

Dec Code 144 50 34 nnn 156

Discussion nnn represents a decimal number indicating the number of bytes available in RAM for rotating fonts.

Character Attributes (SGR)

Character attributes are enhancements that let you highlight your printed text. You can select ten character attributes by using Select Graphic Rendition (SGR) sequences:

- Select font (DEC multinational character set, NLQ, OCR-A, OCR-B)
- Character Expansion via Graphic Size Modification (GSM) sequences (Double height characters, triple height characters, double width characters), if the font was selected by family.
- Select Graphic Rendition (Bold, Italics, Underline, Strike through)

Character attribute sequences share the same basic format as the select font sequence. This type of sequence is called a Select Graphic Rendition (SGR) sequence:

ESC [Ps m

You can select more than one character attribute in the same sequence by including several Ps values separated by semicolons:

ESC [Ps ; Ps ; Ps m

Once set, a character attribute remains active until you turn it off or reset the printer.

Ps = 0 (zero) turns off all character attributes.

Character Expansion (GSM)

ASCII Code ESC [Pn1 ; n2 SP B

Hex Code 1B 5B Ps1 3B n2 20 42

Dec Code 27 91 Ps1 109 n2 32 66

Purpose Pn1 multiplies height; n2 multiplies width.

Discussion The Character Expansion control sequence allows characters to be multiplied in both height and width.

Multiply Height

The printer prints double and triple height characters by expanding the single height character matrix to produce twice or three times the number of vertical dots per character, respectively. Blank lines are expanded to either twice or three times the normal height, equal to the height requested. To alter character height, choose from the following options:

Current Vertical Pitch (LPI)	Pn1 = 200 Double Height (LPI)	Pn1 = 300 Triple Height (LPI)
2	1	
3	1.5	
4	2	
5	2.5	1.7
6	3	2
8	4	2.7
10	5	3.3
12	6	6

When double/triple height mode is selected, the printer expands vertical print until the feature is disabled. This feature can be combined with double width characters. Mixing single, double, and triple height characters on the same horizontal line is allowable.

Multiply Width

The printer prints double width characters by expanding the single width character matrix to produce twice the number of horizontal dots per character. When double width characters are selected, the Space character also expands to twice the normal width. To double character width, invoke the following CPI:

Current Width Pitch (CPI)	n2 = 200 Double Width (CPI)
10	5
12	6
13.3	6.6
15	7.5
16.7	8.3

NOTE: The OCR-A and OCR-B fonts cannot be enlarged. If multiplication escape sequences are used with them, the escape sequence is ignored.

Double width characters are considered one-column wide by the printer. Therefore, existing tab stops are positioned with respect to double width columns. When double width characters are disabled, the tab stops reposition to normal width columns.

A default of 100 is used if no values are set for Pn1 or n2.

When vertical expansion is selected, blank lines are also expanded by the appropriate factor. Likewise, when double width characters are selected, spaces are expanded to the appropriate factor.

Pn1 and n2 may both be set to 50 or 75 if a size reduction is desired.

Bold Printing

ASCII Code ESC [Ps m

Hex Code 1B 5B Ps 6D

Dec Code 27 91 Ps 109

Purpose Turn bold printing on or off.

Discussion This sequence causes the printer to print bold text in the same font currently selected. The values of Ps turn bold printing on or off.

If the currently selected type family does not have a bold font, the printer will double-strike with a slight offset ("shadow print") when you turn on bold printing. Printing speed is reduced during shadow printing because each character is created twice. Note that bolding is not available for OCR-A and OCR-B fonts.

Ps	Printer Action
1	Turn on bold printing
22	Turn off bold printing
0	Turn off all character attributes

If the Print Mode option is set to Enable with the control panel, bold printing will occur with the current print mode font with maximum printer throughput. If Print Mode is set to Disable, a plot mode font is used.

Crossed-Out Text

ASCII Code	ESC [Ps m
Hex Code	1B 5B Ps 6D
Dec Code	27 91 Ps 109
Purpose	Turn crossed-out printing on or off.
Discussion	When enabled, one or more characters print with a cross-through mark.

Ps	Printer Action
9	Enables crossed –out text
29	Disables crossed-out text

Note that crossed-through text printing is not available for OCR-A and OCR-B fonts.

If the Print Mode option is set to Enable with the control panel, crossed-out text will print with the current print mode font with maximum printer throughput. If set to Disable, a plot mode font is used.

Double Underlined Text

ASCII Code	ESC [Ps m
Hex Code	1B 5B Ps 6D
Dec Code	27 91 Ps 109
Purpose	Turns double underlining on or off.
Discussion	With double underlining on, the printer double underlines all following printable characters, including spaces. Double underlining remains in effect (even across page boundaries) until turned off. Note that if you use a tab with double underline enabled, the space is doubly underlined. Ps turns double underlining on or off.

Ps	Printer Action
21	Turn on double underlining
24	Turn off double underlining

This feature is available to all fonts and pitch settings, only when the printer is in Print mode and portrait. Double underlining is disabled when the printer is reset or powered- off.

Italic Printing

ASCII Code ESC [Ps m

Hex Code 1B 5B Ps 6D

Dec Code 27 91 Ps 109

Purpose Turn italic printing on or off.

Discussion Text prints in italics only when OCR-A or OCR-B fonts are not in use and italic printing is selected. The values of Ps turn italic printing on or off.

When the Print Mode option is set to Enable with the control panel, print mode fonts (except for OCR) will be italicized when selected. If set to Disable, underlining is substituted.

Ps	Printer Action
3	Turn on italic printing
23	Turn of italic printing

Overlined

ASCII Code ESC [Ps m

Hex Code 1B 5B Ps 6D

Dec Code 27 91 Ps 109

Purpose Turn overlined printing on or off.

Discussion When enabled, all characters and spaces following the code are overlined. The values of Ps turn overlined printing on or off.

Ps	Printer Action
53	Turn on overlined printing
55	Turn off overlined printing

Overlined text is only applicable in Print mode.

Turn Off All Attributes

ASCII Code ESC [0 m

Hex Code 1B 5B 0 6D

Dec Code 27 91 0 109

Purpose Turns off all font attributes.

Underlined Text

ASCII Code ESC [Ps m

Hex Code 1B 5B Ps 6D

Dec Code 27 91 Ps 109

Purpose Turn underlining on or off.

Discussion With underlining on, the printer underlines all following printable characters, including spaces. Underlining remains in effect (even across page boundaries) until turned off. Note that if you use a tab with underline enabled, the space will be underlined. The values of Ps turn underlining on or off.

Ps	Printer Action
5	Turn on underlining
24	Turn off underlining

This feature is available to all fonts and pitch settings. Underlining is disabled when the printer is reset or powered-off.

Justification (JFY)

ASCII Code ESC [Ps SP F

Hex Code 1B 5B Ps 20 46

Dec Code 27 91 Ps 32 70

Purpose Aligns text at left and right margins.

Discussion Justification changes the spacing between words. With a justified line, the first character of the first word is flush with the left margin, or at the line home position if it differs from the margin setting. The last character of the line will be at the right margin. Once enabled, justification remains on until you turn it off.

Justification places the printer in plot mode. Subsequent text is then printed in the plot font selected. If you do not select a font, solid rectangles are plotted.

The printer evenly spaces each word on a justified line. The space character (SP) indicates a word space to the printer, and you set the limits for word spacing with the Ps parameter, as follows:

Ps	Printer Action
0	Turn off justification (default)
2	Turn on justification with limits
?2	Turn off justification without limits

When justification with limits is set ($P_s = 2$), the printer does not shrink or expand the space character beyond the limits set by the current font (usually in the 50-200% range). If you select justification without limits ($P_s = ?2$), the printer can shrink the space character to zero.

The printer will not make hyphenation or end-of-line determinations when justification is turned on, nor will autowrap operate with justification turned on. Use the following sequences or control characters to make End-of-line determinations:

- Carriage Return <CR>
- Form Feed (FF)
- Line Feed (LF)
- Vertical Tab (VT)
- Next Line (NEL)
- Forward Index (IND)
- Reverse Index (RI)
- Vertical Position Absolute (VPA)

The active font determines the distance between characters in a word. The printer will not autowrap text with justification turned on; therefore, text that exceeds the printable area is lost.

The printer does not justify leading spaces; instead, it uses the default width of the space character (SP). The printer will not shrink or expand the value of Horizontal Position Relative (HPR) sequences in the text. If a line contains Horizontal Tab (HT) or Horizontal Position Absolute (HPA), the printer justifies text between the last HT and the end of the line only.

Sixel Graphics Processing

A sixel is a group of six vertical picture elements (six pixels) that represents a section of a graphic image. It can be sent in one byte (7 or 8 bits). A bit value of 1 means print a pixel; a bit value of 0 means leave a space.

The sixel protocol is a bit-imaged rasterised method of transmitting and displaying graphic images. The printer receives and prints sixel files sent from the host. These images are printed in monochrome.

NOTE: Sixel graphics is invoked in one of two ways: for use with the new software and for use with older software versions. This section describes how to run sixel graphics with the new software. If you are running older software versions, refer to the appropriate manual for sixel graphics information.

Sixel protocol is contained within an ANSI defined Device Control String (DCS) control code. It is invoked by a String Introducer (SI) and is terminated by the String Terminator (ST) control code. The following components make up the complete Device Control String for the sixel protocol:

- String Introducer
- Protocol Selector
- Picture Data
- String Terminator

The Device Control String is assembled as follows:

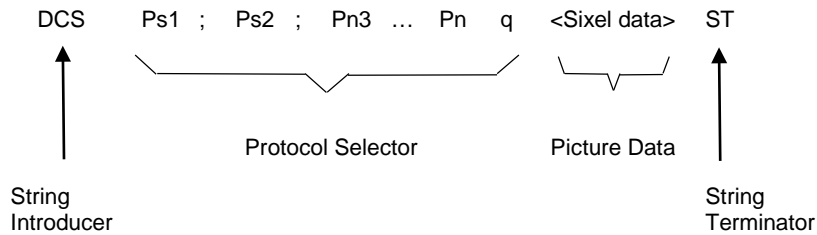

String Introducer

The String Introducer Control code (DCS) identifies the start of the sixel protocol. The DCS code is 90H in 8-bit mode. In 7-bit mode, it is 1BH, 50H.

Protocol Selector

The protocol selector consists of a string of zero, one, or more numeric parameters, each separated by the parameter separator character, ; (semicolon, 3BH). A valid numeric parameter consists of zero, one, or more digits in the range of 30H - 39H. The protocol selector has the following format:

ASCII Code Ps1; Ps2; Pn3 ... Pn q

This selector is defined as follows:

- Set Ps1 to zero and explicitly define the Horizontal Grid Size with the Pn3 parameter. Set the aspect ratio numerator and denominator using the Pn1 and Pn2 parameters in the Sixel Data Control sequence, Set Raster Attributes page 87.

Macro Value	Horizontal Grid Size (inches)	Aspect Ratio (Vert. Pxls;Horz. Pxls)
0 or none	1/140 in (.0071)	200:100
1	1/140 in (.0071)	200:100
1	1/140 in (.0071)	200:100
2, default to:	1/180 in (.0056)	250:100
3, default to:	1/180 in (.0056)	250:100
4	1/180 in (.0056)	250:100
5, default to:	1/140 in (.0071)	200:100
6, default to:	1/140 in (.0071)	200:100
7, default to:	1/140 in (.0071)	200:100
8, default to:	1/140 in (.0071)	200:100
9, default to:	1/70 in (.0143)	100:100

- Macro values 2,3, and 5 through 8 are default definitions required by this printer. If Ps1 is greater than 9, default to Ps1 = 0.
- Ps2 is the background select parameter. It is not used by this printer.

- Pn3 selects horizontal grid size in decipoints (1/720in). This parameter, used with the aspect ratio, defines grid size.

The printer performs default horizontal grid sizes for some decipoint values. The following table identifies the horizontal grid size used for each parameter value.

Decipoints (1/720")	Horizontal Grid Size
0 or none	No change to HGS defined by Ps1
1, 2, 3	1/180in (.0056 in)
4	1/180in (.0056 in)
5	1/180in (.0056 in)
6 default to:	1/180in (.0056 in)
7 default to:	1/180in (.0056 in)
8	1/180in (.0056 in)
9 default to:	1/180in (.0056 in)
10	1/180in (.0056 in)
11 – 19 default to:	1/180in (.0056 in)
20	1/180in (.0056 in)
21, 22, etc. default to:	1/180in (.0056 in)

If Pn3 is set to 0 or not present, the horizontal grid size is determined by the macro parameter (Ps1). Otherwise, Pn3 overrides the Horizontal Grid Size (HGS) portion of the macro parameter while attempting to preserve the aspect ratio (A/R). Therefore, when the 250:100 aspect ratio is selected by Ps1, Pn3 must take on one of the following values:

- 1/180 in, maintain 250:100 A/R and HGS = 1/180 in
- 1/140 in, maintain 250:100 A/R and HGS = 1/180 in
- 1/90 in, maintain 250:100 A/R and maintain HGS = 1/90 in
- 1/70 in, maintain 250:100 A/R and change to HGS = 1/90 in
- 1/35 in, maintain 250:100 A/R and change to HGS = 1/90 in

When the 200:100 aspect ratio is selected by Ps1, Pn3 must take on one of the following values:

- 1/180 in, change to 200:100 A/R and maintain HGS = 1/180 in
- 1/140 in, maintain 200:100 A/R and HGS = 1/140 in
- 1/90 in, maintain 200:100 A/R and change to HGS = 1/140 in
- 1/70 in, maintain 200:100 A/R and change to HGS = 1/70 in
- 1/35 in, maintain 200:100 A/R and change to HGS = 1/70 in

When the 100:100 aspect ratio is selected by Ps1, Pn3 must take on one of the following values:

1/180 in, change to 200:100 A/R and maintain HGS = 1/180 in

1/140 in, maintain 200:100 A/R and change to HGS = 1/140 in

1/90 in, maintain 200:100 A/R and change to HGS = 1/140 in

1/70 in, maintain 200:100 A/R and HGS = 1/70 in

1/35 in, maintain 200:100 A/R and change to HGS = 1/35 in

- Pn is reserved for future use. If parameters are received, they will be ignored without terminating this sequence.
- The final character is designated by the lowercase letter, q, where q identifies the sequence as the sixel protocol selector and places the printer in Sixel Graphics mode.

Three control characters cause the Protocol Selector sequence to terminate and enter Text mode. They are SUB, CAN, and ESC. After the sequence is terminated and Text mode is entered, the process (SUB, CAN, or ESC) enacts. All other codes, if received within the Protocol Selector sequence, are honored without terminating the sequence.

All C1 control codes received while you are defining the Protocol Selector sequence cause the sequence to terminate and the printer to exit from sixel character processing. C1 control codes applicable to this printer are then processed.

Picture Data

Picture data is made up of sixel printable characters and sixel control characters. All picture data is processed while in Sixel Graphics mode. In this mode, instead of standard ASCII Text mode processing, characters are processed by the printer as sixel data, and a graphic image prints.

String Terminator

When the Device Control String parameters have been entered, exit Sixel Graphics mode using the String Terminator (ST) control code. Exit always returns the printer to normal text processing.

Character Processing in Sixel Graphics Mode

In Sixel Graphics mode, characters are made up of standard ASCII text processed as sixel printable characters and sixel control characters.

Sixel Printable Characters

Sixel printable characters are GL characters in the 3F - 7E hex range decoded as printable characters. Each of these 64 values represent an encoding of six vertical pixels to be printed. The actual pixel size is defined by the Horizontal Grid Size parameter and the pixel aspect ratio.

For each bit set to 1, a corresponding print element (or group of elements in double scale), is activated to form a dot. The least significant bit (0) is associated with the top print element or group of elements.

An offset of 3FH is subtracted from each graphics printable character received. This produces a binary value in the 00 - 3F hex range. The 6-bit binary value obtained after this subtraction represents a six-pixel column definition. Note that GR characters in the BF - FE hex range are processed as GL characters by setting the eighth bit to 0. Table 22 shows the binary values for six-pixel column definition.

Table 22 Six-Pixel Column Definition

HEX Code	ASCII Symbol	Binary Value	Pixels	Action
3F	?	000000	None	Advance by a sixel space.
40	@	000001	Top	Print top pixel only.
5F	-	100000	Bottom	Print bottom pixel only.
7E	~	111111	All	Print one full column.

If you try to print past the furthest right position, the printer will truncate all remaining sixel data until the next Graphics Carriage Return (\$) or Graphics New Line (-).

Sixel Control Codes

Sixel control codes are GL characters in the 20 - 3E hex range. The parameter separator (3B hex) and the parameter digits (30 - 39 hex) are also included in this range. GR characters in the A0 - BE hex range are processed as GL characters by setting the eighth bit to 0. Table 23 show how the assigned control characters are processed.

Table 23 Assigned Control Characters

Hex Code	ASCII Symbol	Action
21	!	Repeat Introducer
22	"	Set Raster Attributes
24	\$	Graphic Carriage Return
2D	-	Graphic New Line
30-39	0-9	Numeric Parameters
3B	;	Parameter Separator

A Sixel Graphics Mode sequence begins with a sixel control character (30H - 39H, 3BH exclusive) and ends with a printable character or another sixel control character. If the following data is received:

!- 200~

the printer ignores the repeat control character, processes the Graphic New Line, ignores 200 (it is meaningless by itself), and prints the tilde character once.

Any unassigned control characters, parameters, or parameter separators are ignored by the printer until the next valid control character or ST is received.

Repeat Introducer (!) and Sequence

A repeat sequence allows repetition of certain characters when a valid printable character follows an exclamation point (!), the repeat introducer symbol. For example, the following sequence:

```
!      1      0      ?  
21H   31H   30H   3FH
```

is interpreted to mean "repeat 10 graphic spaces."

The numeric parameter specifies the number of times to print the character that follows the repeat introducer. The numeric parameter is a string of characters in the 30H - 39H range, which is evaluated as a decimal number. If a numeric parameter is not received or if the parameter is 0, a value of 1 is assumed. If the parameter is a value larger than the maximum value of 65535, the printer defaults to 65535. All decimal digits are processed as part of the count.

A repeat sequence is equivalent to receiving the printable character as many times as specified by the numeric parameter count. A printable character ends the repeat sequence processing and causes the printer to print.

Set Raster Attributes

Setting the raster attributes determines the size, shape, and position of the pixels to be drawn.

After entering Sixel Graphics mode, a valid Set Raster Attributes sequence must be received before the first sixel printable character is received. The Set Raster Attributes sequence effects all sixel data that follows.

If a Set Raster Attributes sequence is received after a sixel printable character is received, the printer still recognizes the sequence but disregards all parameters and continues processing all sixel data and control codes that follow the sequence, as if the sequence was never received.

If a Set Raster Attributes sequence is received after a sixel control code (21H - 24H, 2DH), the printer processes the control code and recognizes but ignores all Set Raster Attributes sequences that follow. If a Set Raster Attributes sequence is received after an unspecified LG control code (20H, 25H - 2CH, 2EH, 2FH, 30H - 3EH), the printer ignores the code and processes the Set Raster Attribute sequence that follows. Because of this, you can specify a future control code to be received first, and it will be ignored without consequence to the Set Raster Attributes sequence until the code is recognized by the printer.

If a Set Raster Attributes sequence is received before any other sixel control code, the sequence is processed. The protocol selector has the following format:

ASCII Code " Pn1 ; Pn2 ; Pn3 ; Pn4

This selector is defined as follows:

- The double quote (") sets the raster attributes control characters.
- Pn1 sets the pixel aspect ratio numerator.
- Pn2 sets the pixel aspect ratio denominator.

Pn1 and Pn2 are numeric parameters. A numeric parameter is a string of characters in the 30H - 39H range that is evaluated by the printer as a decimal number. If the parameter is a value larger than the 65535 maximum, the printer defaults to 65535.

The pixel aspect ratio defines the shape of the pixel needed to reproduce the picture without distortion. This ratio is defined by two numbers, a numerator (Pn1) and a denominator (Pn2). It is the ratio of the vertical to the horizontal shape of the pixel. For example, an aspect ratio of 2:1 (or 200:100) represents a pixel twice as high as it is wide. The aspect ratio multiplied by the Horizontal Grid Size (HGS) yields the ideal Vertical Grid Size (VGS). That is:

Pixel Aspect Ratio x HGS = Ideal VGS.

Table 24 gives the aspect ratios supported by the printer.

Table 24 Aspect Ratios Supported by the DEC LG Emulation

Aspect Ratio	Sixel Scale	HGS	Horiz. Dots/Pixel	VGS	Vert. Dots/Pixel
2.5:1	Full	1/180 in	1	1/72 in	1
	2X	1/90 in	2	1/36 in	2
2:1	Full	1/140 in	1	1/72 in	1
	2X	1/70 in	2	1/36 in	2
1:1	.5	1/140 in	1	1/144 in	1/2
	Full	1/70 in	1	1/72 in	1
	2X	1/35 in	2	1/36 in	2

When other aspect ratios (A/R) are requested, they are processed in the following manner:

- An aspect ratio of less than 1.5:1 uses 1:1 A/R.
- An A/R equal to or greater than 1.5:1, but less than 2.25:1 uses 2:1 A/R.
- An A/R equal to or greater than 2.25:1 uses 2.5:1 A/R.

When determining pixel size, the printer will attempt to preserve the A/R without exceeding the selected HGS. Therefore, note the following:

When 2.5:1 A/R is selected and the HGS is:

- 1/180 in, the printer maintains a 2.5:1 A/R and a HGS of 1/180 in
- 1/140 in, the printer maintains a 2.5:1 A/R and a HGS of 1/180 in
- 1/90 in, the printer maintains a 2.5:1 A/R and changes HGS to 1/90 in
- 1/70 in, the printer maintains a 2.5:1 A/R and changes HGS to 1/90 in
- 1/35 in, the printer maintains a 2.5:1 A/R and changes HGS to 1/90 in

Pixel Aspect Ratio x HGS = Ideal VGS.

When 2:1 A/R is selected and the HGS is:

- 1/180 in, change the printer to 2.5:1 A/R and HGS to 1/180 in
- 1/140 in, the printer maintains a 2:1 A/R and a HGS of 1/140 in
- 1/90 in, the printer maintains a 2:1 A/R and a HGS of 1/140 in
- 1/70 in, the printer maintains a 2:1 A/R and changes HGS to 1/70 in
- 1/35 in, the printer maintains a 2:1 A/R and changes HGS to 1/70 in

When 1:1 A/R is selected and the HGS is:

- 1/180 in, the printer maintains a 1:1 A/R and a HGS of 1/180 in
- 1/140 in, the printer maintains a 1:1 A/R and changes HGS to 1/140 in
- 1/90 in, the printer maintains a 1:1 A/R and changes HGS to 1/140 in
- 1/70 in, the printer maintains a 1:1 A/R and a HGS of 1/70 in
- 1/35 in, the printer maintains a 1:1 A/R and changes HGS to 1/35 in

Graphic Carriage Return (\$)

The Graphic Carriage Return (GCR) control code causes the active position to move back to the furthest left position where the first sixel data was printed after entering Sixel Graphics mode. GCR allows sixel data to overprint lines by consecutively starting at the same horizontal position. For example, if the first sixel data prints at column 10, the GCR causes the next line of sixel data to start at column 10 and not at the left margin.

Graphic New Line (-)

The Graphic New Line (GNL) control code initiates printing, causes the active position to move to the furthest left position, and advances paper by one sixel height.

Numeric Parameters (0 - 9)

Some graphic control codes may be followed by a numeric value that is encoded as an ASCII decimal number (0 - 9) in the 30 - 39 hex range. A numeric value is terminated by any non-digit, specifically another control code or a graphics printable character. The default for any numeric parameter is 0.

Parameter Separator (;)

The parameter separator is used to separate a series of numeric parameters. If a number does not precede the separator or does not follow the separator, the printer assumes a value of zero.

ASCII Control Characters

In Sixel Graphics mode, the printer ignores all C0 control characters received except CAN, SUB, and ESC. When the printer receives a CAN control character, it terminates Sixel graphics mode. A SUB control character is processed as 3FH (one sixel space), which limits the effect of some communication line errors. An ESC character terminates Sixel Graphics mode, but the printer still processes the ESC character.

In Sixel Graphics mode, all C1 control codes terminate Sixel Graphics mode, then process the C1 control code if it is recognized by the printer.

Graphic Substitute

In Sixel Graphics mode, the SUB character is interpreted as an error character. The printer remains in Sixel Graphics mode and processes SUB as a sixel space (3FH). If a repeat sequence is processing when SUB is selected, the number of sixel spaces required by the repeat count is printed.

Exit Sixel Graphics Mode

The printer exits Sixel Graphics mode when CAN, ESC, or ST are received. CAN causes the printer to exit Sixel Graphics mode. ESC causes the printer to exit Sixel Graphics mode and begin processing the ESC sequence. ST terminates Sixel Graphics mode.

Note that all stored sixel data is printed before the printer exits Sixel Graphics mode.

State After Exiting Sixel Graphics Mode

After exiting Sixel Graphics mode, the printer returns to the following conditions:

- The horizontal position before entering Sixel Graphics mode
- The horizontal pitch before entering Sixel Graphics mode
- The vertical position might be modified by control characters received while in Sixel Graphics mode
- The vertical pitch is the same as before entering Sixel Graphics mode
- All SGR attributes are restored to the state before entering Sixel Graphics mode
- Additionally, the first Text mode vertical motion command (LF, VT, etc.) causes the printer to advance to the next Text mode line before executing the command.

Processing Unused Control Strings

The printer ignores all unused control strings. Unused control strings include all Operating System commands (OSC), Privacy Messages (PM), and Application Program commands (APC), as well as all Device Control strings (DCS), unless they are within Sixel Graphics mode. The following table describes the different control strings:

Types of Control Strings	8-bit Mnemonic/HEX	7-bit Mnemonic/HEX
Device Control Strings	DCS 90H	ESC P 1BH 50H
Operating System Commands	OSC 9DH	ESC] 1BH 5DH
Privacy Messages	PM 9EH	ESC ^ 1BH 5EH
Application Program Commands	APC 9FH	ESC _ 1BH 5FH

Control string formats appear in the following ways:

Control String Introducer	Data String	String Terminator
DCS P...P I...I F	D...D	ST
OSC	D...D	ST
PM	D...D	ST
APC	D...D	ST

In the above table, P = parameters; I = intermediate characters; F = final character; D = data; and ST = string terminator (9CH).

Process unused control strings as follows:

- After DCS begins processing the introducer sequence, it will:
 1. enter Sixel Graphics mode if the final character is a q
 2. process any applicable C0 received
 3. enter Text mode if ESC, CAN, SUB, ST, or a C1 is received
 4. ignore any GL or GR code received
- After OSC receives an ESC, CAN SUB, ST or C1, it will:
 1. enter Text mode
 2. ignore any other characters

- After PM receives an ESC, CAN SUB, ST or C1, it will:
 1. enter Text mode
 2. ignore any other characters
- After APC receives an ESC, CAN SUB, ST or C1, it will:
 1. enter Text mode
 2. ignore any other characters

Drawing Vectors (DECVEC)

ASCII Code ESC [Pn1 ; Pn2 ; Pn3 ; Pn4 ; Pn5 ; ! |

Hex Code 1B 5B Pn1 3B Pn2 3B Pn3 3B Pn4 3B Pn5 3B 21 7C

Dec Code 27 91 Pn1 59 Pn2 59 Pn3 59 Pn4 59 Pn5 59 33 124

Purpose Draw horizontal or vertical lines with length and width

Discussion Margins do not affect line drawing so you can draw lines to the physical limits of the page. The DECVEC command sequence draws vectors without changing the currently active position.

Use the Pn parameters to select the length, width, and direction of the line. An incorrect Pn value cancels the entire sequence.

Pn1	Operation
0	Draw an x line; that is, horizontal with respect to page orientation.
1	Draw a y line; that is, vertical with respect to page orientation.

- Pn2 selects the x start position on the page in decipoints.
- Pn3 selects the y start position on the page in decipoints.
- Pn4 Selects the line length in the x direction for an x line.
For a y line, it specifies the y direction length.
0 value is equal to a line one decipoint in length.
- Pn5 Selects the line width in the y direction for an x line.
For a y line, it specifies the x direction width.
0 value is equal to a line one decipoint in length.

For an x line, Pn4 specifies the length in the x direction, and Pn5 specifies the width in the y direction. For a y line, Pn4 specifies the length in the y direction, and Pn5 specifies the width in the x direction.

Block Characters

The block character sequences define the parameters of the block characters, initiate the generation of block characters, and return the printer to normal printing. The following subsections describe how to enact these features.

Setting Block Character Parameters (DECBCS)

ASCII Code ESC [P1 ; P2 ; ...P5 ' r
Hex Code 1B 5B P1 3B P2 3B...P5 27 72
Dec Code 27 91 P1 59 P2 59...P5 39 114

Purpose Defines the parameters for block characters.

Discussion The Pn parameters define the height, width, background color, and character set of the block characters. If any parameters are illegal, the entire sequence is ignored. When block character parameters are defined, they remain valid until:

- A new valid Block Character Select Parameter sequence is sent
- A reset command occurs (setting the default values)
- The default values are set by powering-up

The character exists entirely and centrally within the character cell. The line feed distance is equal to the basic cell height multiplied by the vertical magnification factor. The magnification values specified in P1 and P2 are operated on the basic character cell.

Block character parameters are set according to the following choices.

- P1 defines the horizontal magnification factor.

P1	Function
0/missing	Magnification of 2 (default)
1 – 124	Defines the horizontal magnification factor
> 124	Magnification factor of 156 used

The horizontal intercharacter gap for 0 degrees and for 180 degrees rotation is 1/60 inch times the horizontal magnification factor. Characters rotated 90 degrees and 270 degrees have a horizontal intercharacter gap of 3/60 inch times the vertical magnification factor.

- P2 defines the vertical magnification factor. The maximum value of P2 is limited by page length.
- P3 defines the background color.

P3	Function
0/missing	White background (default)
1	Black background (inverse video)

- P4 designates the international character set.

P4	Function
0/missing	U.S. ASCII (default)
1	Germany
2	DEC Norway/Denmark
3	France
4	United Kingdom
5	Spain
6	Sweden
7	Italy
>	uses previous setting

- P5 specifies the block character's orientation.

P5	Function
0/missing	Same as current orientation
1	Portrait (0 degree rotation)
2	Landscape (90 degrees rotation)
3	Reverse landscape (270 degree rotation)
4	Portrait upside down (180 degree rotation)

NOTE: When the sequence selects character rotation, each character is rotated around its axis by the above specified degree.

Start Block Character Mode (DECBLOCKC)

ASCII Code ESC % SP 1

Hex Code 1B 25 20 31

Dec Code 27 37 32 49

Purpose Generates the block characters from the characters that follow the sequence.

Discussion he block characters inherit the last set of parameters defined. If no prior sequence exists, the block characters are printed with:

- 0 degree rotation
- In the U. S. ASCII character set
- With a horizontal and vertical magnification factor of 2
- With a white background

Stop Block Character Mode

ASCII Code ESC % @

Hex Code 1B 25 40

Dec Code 27 37 64

Purpose Stops the generation of block characters

Discussion Once the block character sequence is stopped, the font attributes, the CPI settings, and the LPI settings are returned to their previous values.

Reset to Initial State (RIS)

ASCII Code ESC c

Hex Code 1B 63

Dec Code 27 99

Purpose Resets the value or state of several operating features.

Discussion This sequence resets the printer to a set of operating values and conditions similar to the factory default settings. The operating feature values after a reset are shown in Table 26 page 98.

This sequence and the DECSTR reset sequence have the same function.

Soft Terminal Reset (DECSTR)

ASCII Code ESC [! p

Hex Code 1B 5B 21 70

Dec Code 27 91 33 112

Purpose Resets the value or state of several operating features.

Discussion After receiving a DECSTR, the printer positions itself at the next top of form, then resets the value or state of several operating features. The operating feature values after a reset are shown Table 26 page 98.

An event occurs when more than two intermediate characters are received by the printer. The printer notes this event, waits for the final character, then ignores the entire sequence.

Another way to reset the printer is via the RIS code.

Selecting LinePrinter Plus Emulations via DECIPEM

The DEC LG emulation is the default when printer power is turned on, but you can select the LinePrinter Plus emulation via the DECIPEM control code sequence. (The SOCS control code sequences described on the following page accomplish the same result.) The syntax for this sequence follows:

ASCII: CSI ? 5 8 h

Hex: 9BH 3FH 35H 38H 68H

Entering this control code will select the Proprinter III XL configuration for LinePrinter Plus.

Refer to the Administrator's Manual for information on selecting a LinePrinter Plus protocol and configuring emulation parameters.

Once you have selected LinePrinter Plus using this control code, you may enter the following LG-compatible commands, depending on which emulation is currently selected within LinePrinter Plus:

- If you are in Epson FX or P-Series emulation mode, you may exit back to the LG emulation by entering the RIS command (see page 94).
- If you are in Proprinter III XL emulation mode, you may enter any of the following three commands to return to the LG emulation: RIS, DECSTR (see page 94), or DECIPEM. The DECIPEM escape sequence to exit from the Proprinter III XL emulation follows:

ASCII: ESC [? 5 8 1
Hex: 1BH 5BH 3FH 35H 38H 6CH

Do not use the CSI control code in the DECIPEM control sequence; instead, use its 7-bit equivalent of ESC [.

Do not use any semicolons.

Selecting LinePrinter Plus Emulations via SOCS

The LG emulation is the default when printer power is turned on, but you can select the LinePrinter Plus emulation via two SOCS control code sequences. (The DECIPEM control code sequence described on the previous page accomplishes the same result.) Two acceptable control codes can accomplish this function, as follows:

ASCII: ESC % =
Hex: 1BH 25H 3DH

ASCII: ESC % SP 2
Hex: 1BH 5BH 25H 20H 32H

The first control code sequence selects the Proprinter emulation. The second control code selects the Epson FX-1050.

Refer to the Printronix P5000 series with DEC LG Emulation *Setup Guide* for information on selecting a LinePrinter Plus protocol and configuring emulation parameters.

Once you have selected LinePrinter Plus using this control code, you may enter the following LG-compatible commands depending on which emulation is currently selected within LinePrinter Plus:

- If you are in Epson FX or P-Series emulation mode, you may exit back to the LG emulation by entering the RIS command (see page 94).
- If you are in Proprinter III XL emulation mode, you may enter any of the following three commands to return to the LG emulation: RIS, DECSTR (see page 94), or ROCS. The ROCS escape sequence follows:

ASCII: ESC % @
Hex: 1BH 25H 40H

7-Bit and 8-Bit Transmissions and Interpretations

This section explains how to select 7-bit or 8-bit encoding of control strings.

Select 7-Bit C1 Transmission (S7C1T)

The sequence below causes the printer to use 7-bit encoding for all C1 control characters transmitted. All C1 characters are then represented as two-character ESC sequences.

ASCII: ESC SP F
Hex: 1BH 20 46

Select 8-Bit C1 Transmission (S8C1T)

The sequence below causes the printer to use 8-bit encoding for all C1 control characters transmitted. All C1 characters are then represented as one-character CSI sequences.

ASCII: ESC SP G
Hex: 1BH 20 47

Select 7-Bit Code (S7C1R)

In a 7-bit environment, this sequence allows receipt of 7-bit control strings only.

ASCII: ESC SP 6
Hex: 1BH 20 4A

Select 8-Bit Code (S8C1R)

In an 8-bit environment, this sequence allows receipt of 8-bit control strings only.

ASCII: ESC SP 7
Hex: 1BH 20 37

Enter Draft Mode

ASCII Code ESC % / 3

Hex Code 1B 25 2F 33

Dec Code 27 37 47 51

Purpose Puts the emulation into high speed draft print mode.

Discussion All text following this command will be printed in the high speed draft font. This mode is slightly faster than the normal printing mode because of the simplified font. Only the ASCII character set is available in draft mode. However, if high speed draft is selected via the control panel or the SGR command, multinational character sets are also available.

The high speed draft font can also be selected using the operator's control panel. (Refer to the Administrator's Manual.)

Exit Draft Mode

ASCII Code ESC % @

Hex Code 1B 25 40

Dec Code 27 37 64

Purpose Exit high speed draft mode.

Discussion Upon receipt of this command, the printer returns to the previously selected font and resumes printing or plotting.

Default Values and States

The printer stores a set of typical operating states and conditions. The first time you power up the printer, the factory settings in Table 25 are automatically invoked.

Table 25 Factory Settings

Selectable Parameter	Control Function	Factory Set Condition
Printing Status	----	Off-line
Horizontal Pitch	DEC SHORP	10 characters per inch
Vertical Pitch	DEC VERP	6 lines per inch
Font	SGR	Data Processing
Forms Length	DEC SLPP	66 lines (11 inches)
Active Position	----	Column 1, line 1
Top Margin	----	Line 1
Bottom Margin	----	Line 66
Left Margin	----	Column 1
Right Margin	----	Column 132
Underlining	SGR	Disabled
Bolding	SGR	Disabled
Italics	SGR	Disabled
Double Underline	SGR	Disabled
Overline	SGR	Disabled
Expansion	GSM	No character expansion
GL Character Set	----	US ASCII
GR Character Set	----	DEC Supplemental
G0 Character Set	----	US ASCII
G1 Character Set	----	VT100 Graphic Character Set
G2 Character Set	----	DEC Supplemental
G3 Character Set	----	US ASCII
Autowrap	DECAWM	Disabled

Table 25 Factory Settings

Selectable Parameter	Control Function	Factory Set Condition
Line Feed/New Line Mode	LNM	Reset
Horizontal Tabs	----	Stop at every 8 columns (9, 17...137)
Super/Subscripts	----	Disabled
Carriage Return/NLM	DECCRNLM	Reset
Vertical Tabs	----	Stop at every line (1-66)

Table 26 Reset Condition

Selectable	Control Function	Reset Condition
Printing Status	----	On-line (Ready)
Horizontal Pitch	DECSHORP	10 characters per inch
Vertical Pitch	DECVERP	6 lines per inch
Font	SGR	Data Processing
Forms Length	DECSLPP	66 lines (11 inches)
Active Position	----	Column 1 on the current active line
Top Margin	----	Line 1
Bottom Margin	----	Line 66
Left Margin	----	Column 1
Right Margin	----	Column 132
Underlining	SGR	Disabled
Bolding	SGR	Disabled
Italics	SGR	Disabled
Double Underline	SGR	Disabled
Overline	SGR	Disabled
Expansion	GSM	No character expansion
GL Character Set	----	US ASCII
GR Character Set	----	DEC Supplemental
G0 Character Set	----	US ASCII or the last NRC if selected

Table 26 Reset Condition

Selectable	Control Function	Reset Condition
G1 Character Set	----	VT100 Graphic Character Set
G2 Character Set	----	DEC Supplemental
G3 Character Set	----	US ASCII
Autowrap	DECAWM	Disabled
Line Feed/New Line Mode	LNM	Reset
Horizontal Tabs	----	Stop at every 8 columns (9, 17...137)
Unsolicited Reports	DSR	Disabled
Super/Subscripts	----	Disabled
Carriage Return/New Line Mode	DECCRNLM	Reset
Vertical Tabs	----	Stop at every line (1-66)
Note: The "All Interface Settings" and "National Replacement Character Set" remain as previously selected via escape sequences or the control panel.		

At power-up, the parameter values in Table 27 are automatically retained from the previous power-on session.

Table 27 Power-up Conditions

Selectable Parameter	Control Function	Factory Set Condition
Horizontal Pitch	DEC SHORP	----
Vertical Pitch	DEC VERP	----
Font	SGR	----
Forms Length	DEC SLPP	----
Top and Bottom Margin	DEC STBM	----
Left and Right Margin	DEC SLRM	----
Autowrap	DEC AWM	----
Line Feed/New Line Mode	LNM	----
Carriage Return/New Line Mode	DEC CRNLM	----
Horizontal Tabs	----	----
Vertical Tabs	----	----
Interface Settings	----	----
GL Character Set	----	US ASCII or the last NRC selected
GR Character Set	----	DEC Supplemental
G0 Character Set	----	US ASCII or the last NRC if selected
G1 Character Set	----	VT100 Graphic Character Set
G2 Character Set	----	DEC Supplemental
G3 Character Set	----	US ASCII
Printing Status	----	Off-line
Active Position	----	Column 1 on the current active line
Underlining	SGR	Disabled
Bolding	SGR	Disabled
Italics	SGR	Disabled
Double Underline	SGR	Disabled
Overline	SGR	Disabled
Expansion	GSM	No character expansion
Unsolicited Reports	DSR	Disabled
Super/Subscripts	----	Disabled
Justification	SSU	Disabled

3 *Character Sets*

Introduction

The character sets shown in this chapter are accessible only in LG emulation mode. In this chapter, each character is described in tables that provide character descriptions, as well as hex and decimal character locations. (Appendix A provides graphic representations of the character set matrices.)

Selecting the Character Set and Language

In LG emulation mode, the entire array of language and special character sets can be selected with host control codes as well as the control panel. Character set and language selection is made from the host computer using the SCS control code sequence, described on page 67.

There are no restrictions except for Katakana: It is available only in DP font 10 CPI pitch, and NLQ font 10 CPI pitch.

The DEC ASCII and all language character sets and several fonts can be selected at the printer control panel (see Chapter 4 of the *User's Setup Manual*). You may select the language set and font style from the control panel as follows:

1. At the control panel, select the "LG Font" option, then the Font Character set suboption. Cycle through both GL Character Set and GR Character Set menus to select a current GL and GR Character Set.
2. Select the "LG Font" option, then the Font Style suboption. Cycle through the font style options, and select a font style.

OCR-A and OCR-B

OCR print modes may also be selected from the configuration menus, as described in Chapter 4 of the *Setup Guide*.

OCR print modes do not contain complete character sets. Available OCR-A standard characters are dictated by American National Standard Institute (ANSI) #X3.17-1981, and OCR-A international characters are in accordance with International Organization for Standardization (ISO) #646-1973. Available OCR-B standard and extended characters are dictated by ANSI #X3.49-1975. Undefined OCR characters are replaced with spaces. When an international language substitution is selected for a non-existent character, no substitution will occur.

ASCII Character Set

Graphic symbols of the ASCII Character Set are listed in numeric order by hexadecimal address. Included is the decimal code and the symbol's name.

Table 28 Graphic Symbols for the ASCII Character Set

Hex Value	Decimal Code	Symbol Name
20	32	Space
21	33	Exclamation Point
22	34	Quotation Marks
23	35	Number Sign
24	36	Dollar Sign
25	37	Percent Sign
26	38	Ampersand
27	39	Apostrophe
28	40	Open Parenthesis
29	41	Closed Parenthesis
2A	42	Asterisk
2B	43	Plus
2C	44	Comma
2D	45	Hyphen or Minus
2E	46	Period or Decimal Point
2F	47	Slash
30	48	Zero (Not Slashed)
31	49	One
32	50	Two
33	51	Three
34	52	Four
35	53	Five
36	54	Six
37	55	Seven
38	56	Eight
39	57	Nine
3A	58	Colon
3B	59	Semicolon
3C	60	Less Than Symbol
3D	61	Equals Symbol
3E	62	Greater Than Symbol
3F	63	Question Mark
40	64	At Sign
41	65	Uppercase A
42	66	Uppercase B
43	67	Uppercase C
44	68	Uppercase D

Table 28 Graphic Symbols for the ASCII Character Set

Hex Value	Decimal Code	Symbol Name
45	69	Uppercase E
46	70	Uppercase F
47	71	Uppercase G
48	72	Uppercase H
49	73	Uppercase I
4A	74	Uppercase J
4B	75	Uppercase K
4C	76	Uppercase L
4D	77	Uppercase M
4E	78	Uppercase N
4F	79	Uppercase O
50	80	Uppercase P
51	81	Uppercase Q
52	82	Uppercase R
53	83	Uppercase S
54	84	Uppercase T
55	85	Uppercase U
56	86	Uppercase V
57	87	Uppercase W
58	88	Uppercase X
59	89	Uppercase Y
5A	90	Uppercase Z
5B	91	Open Bracket
5C	92	Backslash
5D	93	Closed Bracket
5E	94	Circumflex
5F	95	Underline
60	96	Open Single Quotation Mark/Grave Accent
61	97	Lowercase a
62	98	Lowercase b
63	99	Lowercase c
64	100	Lowercase d
65	101	Lowercase e
66	102	Lowercase f
67	103	Lowercase g
68	104	Lowercase h
69	105	Lowercase i

Table 28 Graphic Symbols for the ASCII Character Set

Hex Value	Decimal Code	Symbol Name
6A	106	Lowercase j
6B	107	Lowercase k
6C	108	Lowercase l
6D	109	Lowercase m
6E	110	Lowercase n
6F	111	Lowercase o
70	112	Lowercase p
71	113	Lowercase q
72	114	Lowercase r
73	115	Lowercase s
74	116	Lowercase t
75	117	Lowercase u
76	118	Lowercase v
77	119	Lowercase w
78	120	Lowercase x
79	121	Lowercase y
7A	122	Lowercase z
7B	123	Open Brace
7C	124	Solid Vertical Line
7D	125	Closed Brace
7E	126	Tilde
7F	127	Delete

DEC Multinational Character Sets

A symbol set is the alphabet of a font; it is a character set that can be printed regardless of the font characteristics designated for the print job. The default symbol set for the fonts in the printer is the U.S. ASCII set. The U.S. ASCII set is the base onto which other symbol set overlay sequences may be loaded.

Character set overlays contain characters and symbols that replace certain ASCII characters to create international alphabets. The printer contains fourteen multinational character set overlays:

- DEC Great Britain
- DEC Dutch
- DEC Finnish
- French
- DEC French Canadian
- German
- Italian
- JIS Roman
- DEC Norwegian/Danish
- Spanish
- DEC Swedish
- DEC Swiss
- DEC Portuguese
- ISO Norwegian/Danish

The following tables list the replacement characters for the U.S. ASCII set used to make up language-specific symbols. Language symbol characters (National Replacement Characters, or NRCs) are substituted for the U.S. ASCII set at a maximum of twelve locations.

The U.S. ASCII and multinational sets may be selected via the front panel configuration menus or the SCS control code sequence, described on page 67.

NOTE: Appendix A provides graphic representations of the character set matrices.

Table 29 DEC Great Britain Character Set

Hex Value	Dec Code	Symbol Name
23	35	Pound Sign

Table 30 DEC Dutch Character Set

Hex Value	Decimal Code	Symbol Name
023	035	Pound Sign
040	064	Fraction Three-Quarter
05B	091	Lowercase y with Umlaut
05C	092	Fraction One-Half
05D	093	Solid Vertical Bar
07B	123	Umlaut
07C	124	Lowercase f (with Fallback for Florin)
07D	125	Fraction One-Quarter
07E	126	Acute Accent

Table 31 DEC Finnish Character Set

Hex Value	Decimal Code	Symbol Name
05B	091	Uppercase A with Umlaut
05C	092	Uppercase O with Umlaut
05D	093	Uppercase A with Ring
05E	094	Uppercase U with Umlaut
060	096	Lowercase e with Acute Accent
07B	123	Lowercase a with Umlaut
07C	124	Lowercase o with Umlaut
07D	125	Lowercase a with Ring
07E	126	Lowercase u with Umlaut

Table 32 DEC French Character Set

Hex Value	Decimal Code	Symbol Name
023	035	Pound Sign
040	064	Lowercase a with Grave Accent
05B	091	Degree Sign
05C	092	Lowercase c with Cedilla
05D	093	Section Sign
07B	123	Lowercase e with Acute Accent
07C	124	Lowercase u with Grave Accent
07D	125	Lowercase e with Grave Accent
07E	126	Diaeresis (Trema, Umlaut)

Table 33 DEC French Canadian Character Set

Hex Value	Decimal Code	Symbol Name
040	064	Lowercase a with Grave Accent
05B	091	Lowercase a with Circumflex Accent
05C	092	Lowercase c with Cedilla
05D	093	Lowercase e with Circumflex Accent
05E	094	Lowercase i with Circumflex Accent
060	096	Lowercase o with Circumflex Accent
07B	123	Lowercase e with Acute Accent
07C	124	Lowercase u with Grave Accent
07D	125	Lowercase e with Grave Accent
07E	126	Lowercase u with Circumflex Accent

Table 34 German Character Set

Hex Value	Decimal Code	Symbol Name
040	064	Section Sign
05B	091	Uppercase A with Umlaut
05C	092	Uppercase O with Umlaut
05D	093	Uppercase U with Umlaut
07B	123	Lowercase a with Umlaut
07C	124	Lowercase o with Umlaut
07D	125	Lowercase u with Umlaut
07E	126	Sharp S

Table 35 Italian Character Set

Hex Value	Decimal Code	Symbol Name
023	035	Pound Sign
040	064	Section Sign
05B	091	Degree Sign
05C	092	Lowercase c with Cedilla
05D	093	Lowercase e with Acute Accent
060	096	Lowercase u with Grave Accent
07B	123	Lowercase a with Grave Accent
07C	124	Lowercase o with Grave Accent
07D	125	Lowercase e with Grave Accent
07E	126	Lowercase i with Grave Accent

Table 36 JIS Roman Character Set

Hex Value	Decimal Code	Symbol Name
05C	092	Yen Sign

Table 37 DEC Norwegian/Danish Character Set

Hex Value	Decimal Code	Symbol Name
040	035	Uppercase A with Umlaut
05B	091	Uppercase AE Diphthong
05C	092	Uppercase O with Slash
05D	093	Uppercase A with Ring
05E	094	Uppercase U with Umlaut
060	096	Lowercase a with Umlaut
07B	123	Lowercase ae Diphthong
07C	124	Lowercase o with Slash
07D	125	Lowercase a with Ring
07E	126	Lowercase u with Umlaut

Table 38 Spanish Character Set

Hex Value	Decimal Code	Symbol Name
023	035	Pound Sign
040	064	Section Sign
05B	091	Inverted Exclamation Mark
05C	092	Uppercase N with Tilde
05D	093	Inverted Question Mark
07B	123	Degree Sign
07C	124	Lowercase n with Tilde
07D	125	Lowercase c with Cedilla

Table 39 DEC Swedish Character Set

Hex Value	Decimal Code	Symbol Name
040	064	Uppercase E with Acute Accent
05B	091	Uppercase A with Umlaut
05C	092	Uppercase O with Umlaut
05D	093	Uppercase A with Ring
05E	094	Uppercase U with Umlaut
060	096	Lowercase e with Acute Accent
07B	123	Lowercase a with Umlaut
07C	124	Lowercase o with Umlaut
07D	125	Lowercase a with Ring
07E	126	Lowercase u with Umlaut

Table 40 DEC Swiss Character Set

Hex Value	Decimal Code	Symbol Name
023	035	Lowercase u with Grave Accent
040	064	Lowercase a with Grave Accent
05B	091	Lowercase e with Acute Accent
05C	092	Lowercase c with Cedilla
05D	093	Lowercase e with Circumflex Accent
05E	094	Lowercase i with Circumflex Accent
05F	095	Lowercase e with Grave Accent
060	096	Lowercase o with Circumflex Accent
07B	123	Lowercase a with Umlaut Mark
07C	124	Lowercase o with Umlaut Mark
07D	125	Lowercase u with Umlaut Mark
07E	126	Lowercase u with Circumflex Accent

Table 41 DEC Portuguese Character Set

Hex Value	Decimal Code	Symbol Name
05B	091	Uppercase A with Tilde
05C	092	Uppercase C with Cedilla
05D	093	Uppercase O with Tilde
07B	123	Lowercase a with Tilde
07C	124	Lowercase c with Cedilla
07D	125	Lowercase o with Tilde

Table 42 ISO Norwegian/Danish Character Set

Hex Value	Decimal Code	Symbol Name
05B	091	Uppercase AE Diphthong
05C	092	Uppercase O with Slash
05D	093	Uppercase A with Ring
07B	123	Lowercase ae Diphthong
07C	124	Lowercase o with Slash
07D	125	Lowercase a with Ring

Additional ISO and Special Character Sets

The printer can print sixteen character sets in addition to the OCR-A, OCR-B, U.S. ASCII and DEC multinational character sets. These are:

- ISO Cyrillic
- ISO Greek
- ISO Hebrew
- ISO Latin 1
- ISO Latin 2
- ISO Latin 5
- ISO Latin 9
- ISO Katakana
- DEC Supplemental
- VT100 Graphics
- DEC Technical
- 7-Bit Hebrew
- 7-Bit Turkish
- Greek Supplemental
- Hebrew Supplemental
- Turkish Supplemental

The Numeric Character listings for each character set follow. Appendix A provides graphic representations of the character set matrices.

NOTE: The Katakana character set is available only in DP font 10 CPI pitch, and NLQ font 10 CPI pitch.

The DECAUPSS sequence (page 68) may be used to assign the following character sets to the User Reference Supplemental set:

- DEC Supplemental, ISO Latin-1 Supplemental, ISO Latin-Hebrew Supplemental, DEC Technical, ISO Latin-Greek Supplemental, ISO Latin 9

ISO Character Sets

Table 43 ISO Cyrillic Character Set

Hex Value	Decimal Code	Symbol Name
21	33	Uppercase Io
22	34	Uppercase Dje
23	35	Uppercase Gje
24	36	Uppercase Ie
25	37	Uppercase Dze
26	38	Uppercase I
27	39	Uppercase Yi
28	40	Uppercase Je
29	41	Uppercase Lje
2A	42	Uppercase Nje
2B	43	Uppercase Chje
2C	44	Uppercase Kje
2D	45	Space
2E	46	Uppercase short u
2F	47	Uppercase Dze
30	48	Uppercase A
31	49	Uppercase Be
32	50	Uppercase Ve
33	51	Uppercase Ghe
34	52	Uppercase De
35	53	Uppercase Ie
36	54	Uppercase Zhe
37	55	Uppercase Ze
38	56	Uppercase I
39	57	Uppercase I Kratkoe
3A	58	Uppercase Ka
3B	59	Uppercase EI
3C	60	Uppercase Em
3D	61	Uppercase En
3E	62	Uppercase O
3F	63	Uppercase Pe
40	64	Uppercase Er
41	65	Uppercase Es
42	66	Uppercase Te
43	67	Uppercase U

Table 43 ISO Cyrillic Character Set

Hex Value	Decimal Code	Symbol Name
44	68	Uppercase Ef
45	69	Uppercase Ha
46	70	Uppercase Tse
47	71	Uppercase Che
48	72	Uppercase Sha
49	73	Uppercase Shcha
4A	74	Uppercase Hard Sign
4B	75	Uppercase Yeru
4C	76	Uppercase Soft Sign
4D	77	Uppercase E
4E	78	Uppercase Yu
4F	79	Uppercase Ya
50	80	Lowercase A
51	81	Lowercase Be
52	82	Lowercase Ve
53	83	Lowercase Ghe
54	84	Lowercase De
55	85	Lowercase Ie
56	86	Lowercase Zhe
57	87	Lowercase Ze
58	88	Lowercase I
59	89	Lowercase I Kratkoe
5A	90	Lowercase Ka
5B	91	Lowercase El
5C	92	Lowercase Em
5D	93	Lowercase En
5E	94	Lowercase O
5F	95	Lowercase Pe
60	96	Lowercase Er
61	97	Lowercase Es
62	98	Lowercase Te
63	99	Lowercase U
64	100	Lowercase Ef
65	101	Lowercase Ha
66	102	Lowercase Tse
67	103	Lowercase Che
68	104	Lowercase Sha

Table 43 ISO Cyrillic Character Set

Hex Value	Decimal Code	Symbol Name
69	105	Lowercase Shcha
6A	106	Lowercase Hard Sign
6B	107	Lowercase Yeru
6C	108	Lowercase Soft Sign
6D	109	Lowercase E
6E	110	Lowercase Yu
6F	111	Lowercase Ya
70	112	Number Acronym
71	113	Lowercase Io
72	114	Lowercase Dje
73	115	Lowercase Gje
74	116	Lowercase Ie
75	117	Lowercase Dze
76	118	Lowercase I
77	119	Lowercase Yi
78	120	Lowercase Je
79	121	Lowercase Lje
7A	122	Lowercase Nje
7B	123	Lowercase Chje
7C	124	Lowercase Kje
7D	125	Section Sign
7E	126	Lowercase Short u
7F	127	Lowercase Dze

Table 44 ISO Greek Character Set

Hex Value	Decimal Code	Symbol Name
21	33	Grave Mark
22	34	Single Quotation Mark
23	35	Pound Sign
24-25	36-37	Space
26	38	Broken Bar
27	39	Section Sign
28	40	Diaeresis
29	41	Copyright
2A	42	Space
2B	43	Left Angle Quotation Mark
2C	44	Not Sign
2D-2E	45-46	Space
2F	47	Horizontal Bar
30	48	Degree Sign
31	49	Plus or Minus Sign
32	50	Superscript Two
33	51	Superscript Three
34	52	Rough
35	53	Diaeresis Accent Mark
36	54	Uppercase A with Rough
37	55	Small Dot
38	56	Uppercase Epsilon with Rough
39	57	Uppercase Eta with Rough
3A	58	Uppercase Iota with Rough
3B	59	Right Angle Quotation Mark
3C	60	Uppercase Omicron with Rough
3D	61	Fraction One-Half
3E	62	Uppercase Upsilon with Rough
3F	63	Uppercase Omega with Rough
40	64	Lowercase Iota with Rough & Diaeresis
41	65	Uppercase Alpha
42	66	Uppercase Beta
43	67	Uppercase Gamma
44	68	Uppercase Delta
45	69	Uppercase Epsilon
46	70	Uppercase Zeta
47	71	Uppercase Eta

Table 44 ISO Greek Character Set

Hex Value	Decimal Code	Symbol Name
48	72	Uppercase Theta
49	73	Uppercase Iota
4A	74	Uppercase Kappa
4B	75	Uppercase Lamda
4C	76	Uppercase Mu
4D	77	Uppercase Nu
4E	78	Uppercase Ksi
4F	79	Uppercase Omicron
50	80	Uppercase Pi
51	81	Uppercase Rho
52	82	Space
53	83	Uppercase Sigma
54	84	Uppercase Tau
55	85	Uppercase Upsilon
56	86	Uppercase Phi
57	87	Uppercase Khi
58	88	Uppercase Psi
59	89	Uppercase Omega
5A	90	Uppercase I with Diaeresis
5B	91	Uppercase Upsilon with Diaeresis
5C	92	Lowercase Alpha with Rough
5D	93	Lowercase Epsilon with Rough
5E	94	Lowercase Eta with Rough
5F	95	Lowercase Iota with Rough
60	96	Lowercase Epsilon with Umlaut and Rough
61	97	Lowercase Alpha
62	98	Lowercase Beta
63	99	Lowercase Gamma
64	100	Lowercase Delta
65	101	Lowercase Epsilon
66	102	Lowercase Zeta
67	103	Lowercase Eta
68	104	Lowercase Theta
69	105	Lowercase Iota
6A	106	Lowercase Kappa
6B	107	Lowercase Lambda
6C	108	Lowercase Mu

Table 44 ISO Greek Character Set

Hex Value	Decimal Code	Symbol Name
6D	109	Lowercase Nu
6E	110	Lowercase Ksi
6F	111	Lowercase Omicron
70	112	Lowercase Pi
71	113	Lowercase Rho
72	114	Lowercase Terminal Sign
73	115	Lowercase Sigma
74	116	Lowercase Tau
75	117	Lowercase Upsilon
76	118	Lowercase Phi
77	119	Lowercase Chi
78	120	Lowercase Psi
79	121	Lowercase Omega
7A	122	Lowercase Iota with Y with Diaeresis
7B	123	Lowercase Upsilon with Diaeresis
7C	124	Lowercase Omicron with Rough
7D	125	Lowercase Upsilon with Rough
7E	126	Lowercase Omega with Rough
7F	127	Space

Table 45 ISO Hebrew Character Set

Hex Value	Decimal Code	Symbol Name
21	33	Space
22	34	Cent Sign
23	35	Pound Sign
24	36	Currency Sign
25	37	Yen Sign
26	38	Broken Bar
27	39	Section Sign
28	40	Diaeresis
29	41	Copyright Symbol
2A	42	Multiply Sign
2B	43	Left Angle Quote
2C	44	Not Sign
2D	45	Space
2E	46	Registered Trade Mark
2F	47	Line Above
30	48	Degree Symbol
31	49	Plus or Minus
32	50	Superscript Two
33	51	Superscript Three
34	52	Single Quote
35	53	Lowercase Mu
36	54	Paragraph Sign
37	55	Small Dot
38	56	Cedilla
39	57	Superscript One
3A	58	Divide Sign
3B	59	Right Angle Quote
3C	60	Fraction One-Quarter
3D	61	Fraction One-Half
3E	62	Fraction Three-Quarters
3F	63	Space
40-5E	64-94	Space
5F	95	Double Low Line
60	96	Aleph
61	97	Bet
62	98	Gimel
63	99	Dalet

Table 45 ISO Hebrew Character Set

Hex Value	Decimal Code	Symbol Name
64	100	He
65	101	Waw
66	102	Zain
67	103	Chet
68	104	Tet
69	105	Yod
6A	106	Kaph with Terminal
6B	107	Kaph
6C	108	Lamed
6D	109	Mem with Terminal
6E	110	Mem
6F	111	Nun with Terminal
70	112	Nun
71	113	Samech
72	114	Ayin
73	115	Pe with Terminal
74	116	Pe
75	117	Zade with Terminal
76	118	Zade
77	119	Qoph
78	120	Resh
79	121	Shin
7A	122	Taw
7B-7F	123-127	Space

Table 46 ISO Latin 2 Character Set

Hex Value	Decimal Code	Symbol Name
21	33	Uppercase A with Ogonek
22	34	Breve
23	35	Uppercase L with Bar
24	36	Currency Sign
25	37	Uppercase L with Caron
26	38	Uppercase S with Acute
27	39	Section Sign
28	40	Diaeresis
29	41	Uppercase S with Caron
2A	42	Uppercase S with Cedilla
2B	43	Uppercase T with Caron
2C	44	Uppercase Z with Acute
2D	45	Space
2E	46	Uppercase Z with Caron
2F	47	Uppercase Z with Dot
30	48	Degree
31	49	Lowercase A with Ogonek
32	50	Ogonek
33	51	Lowercase L with Bar
34	52	Acute Accent
35	53	Lowercase L with Caron
36	54	Lowercase S with Acute
37	55	Caron Mark
38	56	Cedilla
39	57	Lowercase S with Caron
3A	58	Lowercase S with Cedilla
3B	59	Lowercase T with Caron
3C	60	Lowercase Z with Acute
3D	61	D with Acute Accent
3E	62	Lowercase Z with Caron
3F	63	Lowercase Z with Dot
40	64	Uppercase R with Acute
41	65	Uppercase A with Acute
42	66	Uppercase A with Circumflex
43	67	Uppercase A with Breve
44	68	Uppercase A with Diaeresis
45	69	Uppercase L with Acute

Table 46 ISO Latin 2 Character Set

Hex Value	Decimal Code	Symbol Name
46	70	Uppercase C with Acute
47	71	Uppercase C with Cedilla
48	72	Uppercase C with Caron
49	73	Uppercase E with Acute
4A	74	Uppercase E with Ogonek
4B	75	Uppercase E with Diaeresis
4C	76	Uppercase E with Caron
4D	77	Uppercase I with Acute
4E	78	Uppercase I with Circumflex
4F	79	Uppercase D with Caron
50	80	Uppercase D with Stroke
51	81	Uppercase N with Acute
52	82	Uppercase N with Caron
53	83	Uppercase O with Acute
54	84	Uppercase O with Circumflex
55	85	Uppercase O with Acute
56	86	Uppercase O with Diaeresis
57	87	Multiply Sign
58	88	Uppercase R with Caron
59	89	Uppercase U with Ring Above
5A	90	Uppercase U with Acute
5B	91	Uppercase U with Acute
5C	92	Uppercase U with Diaeresis
5D	93	Uppercase Y with Acute
5E	94	Uppercase T with Cedilla
5F	95	Sharp S
60	96	Lowercase R with Acute
61	97	Lowercase A with Acute
62	98	Lowercase A with Circumflex
63	99	Lowercase A with Breve
64	100	Lowercase A with Diaeresis
65	101	Lowercase L with Acute
66	102	Lowercase C with Acute
67	103	Lowercase C with Cedilla
68	104	Lowercase C with Caron
69	105	Lowercase E with Acute
6A	106	Lowercase E with Ogonek

Table 46 ISO Latin 2 Character Set

Hex Value	Decimal Code	Symbol Name
6B	107	Lowercase E with Diaeresis
6C	108	Lowercase E with Circumflex
6D	109	Lowercase I with Acute
6E	110	Lowercase I with Circumflex
6F	111	Lowercase D with Caron
70	112	Lowercase D with Stroke
71	113	Lowercase N with Acute
72	114	Lowercase N with Caron
73	115	Lowercase O with Acute
74	116	Lowercase O with Circumflex
75	117	Lowercase OD with Acute
76	118	Lowercase O with Diaeresis
77	119	Divide Sign
78	120	Lowercase R with Caron
79	121	Lowercase U with Ring Above
7A	122	Lowercase U with Acute
7B	123	Lowercase UD with Acute
7C	124	Lowercase U with Diaeresis
7D	125	Lowercase Y with Acute
7E	126	Lowercase T with Cedilla
7F	127	Superscript Dot

Table 47 ISO Latin 5 Character Set

Hex Value	Decimal Code	Symbol Name
21	33	Inverted Exclamation Mark
22	34	Cent Sign
23	35	Pound Sign
24	36	Currency Sign
25	37	Yen Sign
26	38	Broken Bar
27	39	Section Sign
28	40	Diaeresis
29	41	Copyright Symbol
2A	42	Feminine Ordinal Indicator
2B	43	Left Angle Quotation Mark
2C	44	Not Sign
2D	45	Space
2E	46	Registered Trade Mark
2F	47	Macron
30	48	Degree Sign
31	49	Plus or Minus Sign
32	50	Superscript Two
33	51	Superscript Three
34	52	Single Quotation Mark
35	53	Lowercase Mu
36	54	Paragraph Sign
37	55	Small Dot
38	56	Cedilla
39	57	Superscript One
3A	58	Masculine Ordinal Indicator
3B	59	Right Angle Quotation Mark
3C	60	Fraction One-Quarter
3D	61	Fraction One-Half
3E	62	Fraction Three-Quarters
3F	63	Inverted Question Mark
40	64	Uppercase A with Grave
41	65	Uppercase A with Actue
42	66	Uppercase A with Circumflex
43	67	Uppercase A with Tilde
44	68	Uppercase A with Diaeresis
45	69	Uppercase A with Ring

Table 47 ISO Latin 5 Character Set

Hex Value	Decimal Code	Symbol Name
46	70	Uppercase AE Diphthong
47	71	Uppercase C with Cedilla
48	72	Uppercase E with Grave
49	73	Uppercase E with Actue
4A	74	Uppercase E with Circumflex
4B	75	Uppercase E with Diaeresis
4C	76	Uppercase I with Grave Mark
4D	77	Uppercase I with Acute
4E	78	Uppercase I with Circumflex
4F	79	Uppercase I with Diaeresis
50	80	Uppercase G with Breve
51	81	Uppercase N with Tilde
52	82	Uppercase O with Grave
53	83	Uppercase O with Acute
54	84	Uppercase O with Circumflex
55	85	Uppercase O with Tilde
56	86	Uppercase O with Diaeresis
57	87	Multiply Sign
58	88	Uppercase O with Slash
59	89	Uppercase U with Grave
5A	90	Uppercase U with Acute
5B	91	Uppercase U with Circumflex
5C	92	Uppercase U with Diaeresis
5D	93	Uppercase I with Ring Above
5E	94	Uppercase S with Cedilla
5F	95	Sharp S
60	96	Lowercase A with Grave
61	97	Lowercase A with Acute
62	98	Lowercase A with Circumflex
63	99	Lowercase A with Tilde
64	100	Lowercase A with Diaeresis
65	101	Lowercase A with Ring Above
66	102	Lowercase AE Diphthong
67	103	Lowercase C with Cedilla
68	104	Lowercase E with Grave
69	105	Lowercase E with Acute
6A	106	Lowercase E with Circumflex

Table 47 ISO Latin 5 Character Set

Hex Value	Decimal Code	Symbol Name
6B	107	Lowercase E with Diaeresis
6C	108	Lowercase I with Grave
6D	109	Lowercase I with Acute
6E	110	Lowercase I with Circumflex
6F	111	Lowercase I with Diaeresis
70	112	Lowecase G with Breve
71	113	Lowercase N with Tilde
72	114	Lowercase O with Grave
73	115	Lowercase O with Acute
74	116	Lowercase O with Circumflex
75	117	Lowercase O with Tilde
76	118	Lowercase O with Diaeresis
77	119	Divide Sign
78	120	Lowercase O with Slash
79	121	Lowercase U with Grave
7A	122	Lowercase U with Acute
7B	123	Lowercase U with Circumflex
7C	124	Lowercase U with Diaeresis
7D	125	Lowercase I
7E	126	Lowercase S with Cedilla
7F	127	Uppercase Y with Diaeresis

DEC Supplemental Character Set

The DEC Supplemental Character Set consists of graphic alphabetical symbols not included in the ASCII Character Set. Character positions identified as “reserved for future use” print the error character (reverse question mark).

Table 48 gives the 7-bit code for each character. The equivalent 8-bit code is obtained by adding octal 200 or hex 80 to the 7-bit code.

Table 48 DEC Supplemental Character Set

Hex Value	Decimal Code	Symbol Name
20	32	Space
21	33	Inverted Exclamation Mark
22	34	Cent Sign
23	35	Pound Sign
24	36	Reserved for Future Use
25	37	Yen Sign
26	38	Reserved for Future Use
27	39	Section Sign
28	40	General Currency Sign
29	41	Copyright Sign
2A	42	Feminine Ordinal Indicator
2B	43	Angle Quotation Mark - Left
2C-2F	44-47	Reserved for Future Use
30	48	Degree Sign
31	49	Plus/Minus Sign
32	50	Superscript 2
33	51	Superscript 3
34	52	Reserved for Future Use
35	53	Micro Sign
36	54	Paragraph Sign (Pilcrow)
37	55	Middle Dot
38	56	Reserved for Future Use
39	57	Superscript 1
3A	58	Masculine Ordinal Indicator
3B	59	Angle Quotation Mark (Right)
3C	60	Fraction One-Quarter Mark
3D	61	Fraction One-Quarter Mark
3E	62	Reserved for Future Use
3F	63	Inverted Question Mark
40	64	Uppercase A with Grave Accent
41	65	Uppercase A with Acute Accent

Table 48 DEC Supplemental Character Set

Hex Value	Decimal Code	Symbol Name
42	66	Uppercase A with Circumflex Accent
43	67	Uppercase A with Tilde
44	68	Uppercase A with Diaeresis
45	69	Uppercase A with Ring
46	70	Uppercase AE Diphthong
47	71	Uppercase C with Cedilla
48	72	Uppercase E with Grave
49	73	Uppercase E with Acute
4A	74	Uppercase E with Circumflex Accent
4B	75	Uppercase E with Diaeresis
4C	76	Uppercase I with Grave
4D	77	Uppercase I with Acute
4E	78	Uppercase I with Circumflex Accent
4F	79	Uppercase I with Diaeresis
50	80	Reserved for Future Use
51	81	Uppercase N with Tilde
52	82	Uppercase O with Grave
53	83	Uppercase O with Acute
54	84	Uppercase O with Circumflex Accent
55	85	Uppercase O with Tilde
56	86	Uppercase O with Diaeresis
57	87	Uppercase OE Ligature
58	88	Uppercase O with Slash
59	89	Uppercase O with Grave
5A	90	Uppercase U with Acute
5B	91	Uppercase U with Circumflex Accent
5C	92	Uppercase U with Diaeresis or Diaeresis
5D	93	Uppercase Y with Diaeresis
5E	94	Reserved for Future Use
5F	95	Sharp S
60	96	Lowercase a with Grave
61	97	Lowercase a with Acute
62	98	Lowercase a with Circumflex Accent
63	99	Lowercase a with Tilde
64	100	Lowercase a with Diaeresis
65	101	Lowercase a with Ring
66	102	Lowercase ae Diphthong

Table 48 DEC Supplemental Character Set

Hex Value	Decimal Code	Symbol Name
67	103	Lowercase c with Cedilla
68	104	Lowercase e with Grave
69	105	Lowercase e with Acute
6A	106	Lowercase e with Circumflex Accent
6B	107	Lowercase e with Diaeresis
6C	108	Lowercase i with Grave
6D	109	Lowercase i with Acute
6E	110	Lowercase i with Circumflex Accent
6F	111	Lowercase i with Diaeresis
70	112	Reserved for Future Use
71	113	Lowercase n with Tilde
72	114	Lowercase o with Grave
73	115	Lowercase o with Acute
74	116	Lowercase o with Circumflex Accent
75	117	Lowercase o with Tilde
76	118	Lowercase o with Diaeresis
77	119	Lowercase oe Ligature
78	120	Lowercase o with Slash
79	121	Lowercase u with Grave
7A	122	Lowercase u with Acute
7B	123	Lowercase u with Circumflex Accent
7C	124	Lowercase u with Diaeresis
7D	125	Lowercase y with Diaeresis
7E	126	Reserved for Future Use
7F	127	Delete

VT100 Graphics Character Set

The VT100 Graphics Character Set contains ASCII and special graphic symbols. Several characters in this set that are also found in the DEC Technical Character Set or the DEC Supplemental Character Set. Line drawing characters are identified in Table 49 by an asterisk after the hex value.

NOTE: This character set is available in DP font 10 CPI pitch only.

NOTE: *Denotes those characters used for line drawing.

¹Denotes characters also found in the DEC Technical Character Set

²Denotes characters also found in the DEC Supplemental Character Set

Table 49 VT100 Graphics Character Set

Hex Value	Decimal Code	Symbol Name
20	32	Space
21	33	Exclamation Point
22	34	Double Quotation Mark
23	35	Number Sign
24	36	Dollar Sign
25	37	Percent Sign
26	38	Ampersand
27	39	Single Quotation Mark
28	40	Open Parenthesis
29	41	Closed Parenthesis
2A	42	Asterisk
2B	43	Plus
2C	44	Comma
2D	45	Hyphen or Minus
2E	46	Period or Decimal Point
2F	47	Slash
30	48	Zero (Not Slashed)
31	49	One
32	50	Two
33	51	Three
34	52	Four
35	53	Five
36	54	Six
37	55	Seven
38	56	Eight
39	57	Nine
3A	58	Colon
3B	59	Semicolon

Table 49 VT100 Graphics Character Set

Hex Value	Decimal Code	Symbol Name
3C	60	Less Than Symbol
3D	61	Equals Symbol
3E	62	Greater Than Symbol
3F	63	Question Mark
40	64	At Sign
41	65	Uppercase A
42	66	Uppercase B
43	67	Uppercase C
44	68	Uppercase D
45	69	Uppercase E
46	70	Uppercase F
47	71	Uppercase G
48	72	Uppercase H
49	73	Uppercase I
4A	74	Uppercase J
4B	75	Uppercase K
4C	76	Uppercase L
4D	77	Uppercase M
4E	78	Uppercase N
4F	79	Uppercase O
50	80	Uppercase P
51	81	Uppercase Q
52	82	Uppercase R
53	83	Uppercase S
54	84	Uppercase T
55	85	Uppercase U
56	86	Uppercase V
57	87	Uppercase W
58	88	Uppercase X
59	89	Uppercase Y
5A	90	Uppercase Z
5B	91	Open Bracket
5C	92	Backslash
5D	93	Closed Bracket
5E	94	Circumflex
5F*	95	Space
60*	96	Solid Diamond

Table 49 VT100 Graphics Character Set

Hex Value	Decimal Code	Symbol Name
61*	97	Solid Box
62*	98	Horizontal Tab
63*	99	Form Feed
64*	100	Carriage Return
65*	101	Line Feed
66*	102	Degree Symbol ²
67*	103	Plus/Minus Sign ²
68*	104	New Line
69*	105	Vertical Tab
6A*	106	Graphics Bar Lower Right Corner
6B*	107	Graphics Bar Upper Right Corner
6C*	108	Graphics Bar Upper Left Corner
6D*	109	Graphics Bar Lower Left Corner
6E*	110	Crossing Lines
6F*	111	Horizontal Line, Scan 1
70*	112	Horizontal Line, Scan 3
71*	113	Horizontal Line, Scan 5
72*	114	Horizontal Line, Scan 7
73*	115	Horizontal Line, Scan 9
74*	116	Left T
75*	117	Right T
76*	118	Bottom T
77*	119	Top T
78*	120	Vertical Bar
79*	121	Less Than or Equal To Sign ¹
7A*	122	Greater Than or Equal To Sign ¹
7B*	123	Lowercase Greek Letter Pi ¹
7C*	124	Not Equal Sign ¹
7D*	125	Pound Sign ²
7E*	126	Big Dot ²
7F	127	Delete

DEC Technical Character Set

The DEC Technical Character Set contains Greek letters, mathematical symbols, and logical symbols. Additionally, it contains characters that may be used to construct larger mathematical symbols on character cell devices, such as large integral and summation signs. Select this character set via the SCS control sequence, as described on page 67.

The technical character set is output to the terminal via software that responds to the ANSI/ISO Single Shift 3 (SS3) non-locking shift control function. SS3 is already terminal-resident--just enter the hex value from Table 50 to produce the appropriate character. The set has no duplicate ASCII or DEC Supplemental characters. Eleven positions are reserved for future standardization, including the corners, hex 20 and hex 7F.

The printer conforms to the following:

- Responds to the escape sequence that determines the DEC Technical Character Set. The printer cannot designate or invoke the DEC Technical Character Set by default.
- Positions reserved for future standardization in the DEC technical set are imaged as the error character (reverse question mark).
- Component characters are imaged so that adjacent component characters form connected lines at all pitches.

Table 50 DEC Technical Character Set

Hex Value	Decimal Code	Symbol Name
Greek:		
44	68	Uppercase Delta
46	70	Uppercase Phi
47	71	Uppercase Gamma
4A	74	Uppercase Theta
4C	76	Uppercase Lambda
50	80	Uppercase Pi
51	81	Uppercase Psi
53	83	Uppercase Sigma
57	87	Uppercase Omega
58	88	Uppercase Ksi
59	89	Uppercase Upsilon
61	97	Lowercase Alpha
62	98	Lowercase Beta
63	99	Lowercase Gamma
64	100	Lowercase Delta
65	101	Lowercase Epsilon
66	102	Lowercase Phi
67	103	Lowercase Gamma
68	104	Lowercase Eta
69	105	Lowercase Iota
6A	106	Lowercase Theta

Table 50 DEC Technical Character Set

Hex Value	Decimal Code	Symbol Name
6B	107	Lowercase Kappa
6C	108	Lowercase Lambda
6E	110	Lowercase Nu
70	112	Lowercase Pi
71	113	Lowercase Psi
72	114	Lowercase Rho
73	115	Lowercase Sigma
74	116	Lowercase Tau
77	119	Lowercase Omega
78	120	Lowercase Ksi
79	121	Lowercase Upsilon
7A	122	Lowercase Zeta
Mathematical:		
3C	60	Less Than or Equal To
3D	61	Not Equal
3E	62	Greater Than or Equal To
3F	63	Integral
41	65	Variation or Proportional To ¹
42	66	Infinity
43	67	Division or Divided By
45	69	Nabla or Del
48	72	Is Approximate To
49	73	Similar or Equal To
4B	75	Times or Cross Product
56	86	Radical
6F	111	Partial Derivative
76	118	Function
7B	123	Left Arrow
7C	124	Upward Arrow
7D	125	Right Arrow
7E	126	Downward Arrow

Table 50 DEC Technical Character Set

Hex Value	Decimal Code	Symbol Name
Logic:		
40	64	Therefore
4D	77	If and Only If
4E	78	Implies
4F	79	Identical To
5A	90	Is Included In
5B	91	Includes
5C	92	Intersection
5D	93	Union
5E	94	Logical And
5F	95	Logical Or
60	96	Logical Not

Table 51 ISO Katakana Character Set

Hex Value	Decimal Code	Symbol Name
21	33	Katakana full stop
22	34	Katakana opening bracket
23	35	Katakana closing bracket
24	36	Katakana comma
25	37	Katakana conjunctive symbol
26	38	Katakana wo
27	39	Katakana small a
28	40	Katakana small i
29	41	Katakana small u
2A	42	Katakana small e
2B	43	Katakana small o
2C	44	Katakana small ya
2D	45	Katakana small yu
2E	46	Katakana small yo
2F	47	Katakana small tsu
30	48	Katakana prolonged sound symbol
31	49	Katakana a
32	50	Katakana i
33	51	Katakana u
34	52	Katakana e

Table 51 ISO Katakana Character Set

Hex Value	Decimal Code	Symbol Name
35	53	Katakana o
36	54	Katakana ka
37	55	Katakana ki
38	56	Katakana ku
39	57	Katakana ke
3A	58	Katakana ko
3B	59	Katakana sa
3C	60	Katakana shi
3D	61	Katakana su
3E	62	Katakana se
3F	63	Katakana so
40	64	Katakana ta
41	65	Katakana chi
42	66	Katakana tsu
43	67	Katakana te
44	68	Katakana to
45	69	Katakana na
46	70	Katakana ni
47	71	Katakana nu
48	72	Katakana ne
49	73	Katakana no
4A	74	Katakana ha
4B	75	Katakana hi
4C	76	Katakana fu
4D	77	Katakana he
4E	78	Katakana ho
4F	79	Katakana ma
50	80	Katakana mi
51	81	Katakana mu
52	82	Katakana me
53	83	Katakana mo
54	84	Katakana ya
55	85	Katakana yu
56	86	Katakana yo
57	87	Katakana ra
58	88	Katakana ri
59	89	Katakana ru

Table 51 ISO Katakana Character Set

Hex Value	Decimal Code	Symbol Name
5A	90	Katakana re
5B	91	Katakana ro
5C	92	Katakana wa
5D	93	Katakana n(m)
5E	94	Katakana voiced sound symbol
5F	95	Katakana semi-voiced sound symbol
60-7E	96-126	(Reserved for future use)

Table 52 7-Bit Hebrew Character Set

Hex Value	Decimal Code	Symbol Name
20	32	Space
21	33	Exclamation Point
22	34	Quotation Marks
23	35	Number Sign
24	36	Dollar Sign
25	37	Percent Sign
26	38	Ampersand
27	39	Apostrophe
28	40	Open Parenthesis
29	41	Closed Parenthesis
2A	42	Asterisk
2B	43	Plus
2C	44	Comma
2D	45	Hyphen or Minus
2E	46	Period or Decimal Point
2F	47	Slash
30	48	Zero (Not Slashed)
31	49	One
32	50	Two
33	51	Three
34	52	Four
35	53	Five
36	54	Six
37	55	Seven
38	56	Eight

Table 52 7-Bit Hebrew Character Set

Hex Value	Decimal Code	Symbol Name
39	57	Nine
3A	58	Colon
3B	59	Semicolon
3C	60	Less Than Symbol
3D	61	Equals Symbol
3E	62	Greater Than Symbol
3F	63	Question Mark
40	64	At Sign
41	65	Uppercase A
42	66	Uppercase B
43	67	Uppercase C
44	68	Uppercase D
45	69	Uppercase E
46	70	Uppercase F
47	71	Uppercase G
48	72	Uppercase H
49	73	Uppercase I
4A	74	Uppercase J
4B	75	Uppercase K
4C	76	Uppercase L
4D	77	Uppercase M
4E	78	Uppercase N
4F	79	Uppercase O
50	80	Uppercase P
51	81	Uppercase Q
52	82	Uppercase R
53	83	Uppercase S
54	84	Uppercase T
55	85	Uppercase U
56	86	Uppercase V
57	87	Uppercase W
58	88	Uppercase X
59	89	Uppercase Y
5A	90	Uppercase Z
5B	91	Open Bracket
5C	92	Backslash
5D	93	Closed Bracket

Table 52 7-Bit Hebrew Character Set

Hex Value	Decimal Code	Symbol Name
5E	94	Circumflex
5F	95	Underline
60	96	Hebrew letter ALEPH
61	97	Hebrew letter BETH
62	98	Hebrew letter GIMMEL
63	99	Hebrew letter DALETH
64	100	Hebrew letter HE
65	101	Hebrew letter WAW
66	102	Hebrew letter ZAYIN
67	103	Hebrew letter HET
68	104	Hebrew letter TETH
69	105	Hebrew letter YOD
6A	106	Hebrew letter KAPH (Final Form)
6B	107	Hebrew letter KAPH
6C	108	Hebrew letter LAMED
6D	109	Hebrew letter MEM (Final Form)
6E	110	Hebrew letter MEM
6F	111	Hebrew letter NUN (Final Form)
70	112	Hebrew letter NUN
71	113	Hebrew letter SAMEKH
72	114	Hebrew letter A'YIN
73	115	Hebrew letter PE (Final Form)
74	116	Hebrew letter PE
75	117	Hebrew letter ZADIK (Final Form)
76	118	Hebrew letter ZADIK
77	119	Hebrew letter KOF/KUF
78	120	Hebrew letter RESH
79	121	Hebrew letter SHIN/SIN
7A	122	Hebrew letter TAF
7B	123	Open Brace
7C	124	Solid Vertical Line
7D	125	Closed Brace
7E	126	Tilde
7F	127	Delete

Table 53 7-Bit Turkish Character Set

Hex Value	Decimal Code	Symbol Name
20	32	Space
21	33	Small Letter i Without Dot
22	34	Quotation Marks
23	35	Number Sign
24	36	Dollar Sign
25	37	Percent Sign
26	38	Small Letter g With Breve
27	39	Apostrophe
28	40	Open Parenthesis
29	41	Closed Parenthesis
2A	42	Asterisk
2B	43	Plus
2C	44	Comma
2D	45	Hyphen or Minus
2E	46	Period or Decimal Point
2F	47	Slash
30	48	Zero (Not Slashed)
31	49	One
32	50	Two
33	51	Three
34	52	Four
35	53	Five
36	54	Six
37	55	Seven
38	56	Eight
39	57	Nine
3A	58	Colon
3B	59	Semicolon
3C	60	Less Than Symbol
3D	61	Equals Symbol
3E	62	Greater Than Symbol
3F	63	Question Mark
40	64	Capital Letter I With Dot Above
41	65	Uppercase A
42	66	Uppercase B
43	67	Uppercase C
44	68	Uppercase D

Table 53 7-Bit Turkish Character Set

Hex Value	Decimal Code	Symbol Name
45	69	Uppercase E
46	70	Uppercase F
47	71	Uppercase G
48	72	Uppercase H
49	73	Uppercase I
4A	74	Uppercase J
4B	75	Uppercase K
4C	76	Uppercase L
4D	77	Uppercase M
4E	78	Uppercase N
4F	79	Uppercase O
50	80	Uppercase P
51	81	Uppercase Q
52	82	Uppercase R
53	83	Uppercase S
54	84	Uppercase T
55	85	Uppercase U
56	86	Uppercase V
57	87	Uppercase W
58	88	Uppercase X
59	89	Uppercase Y
5A	90	Uppercase Z
5B	91	Capital Letter S With Cedilla Below
5C	92	Capital Letter O With Diaeresis
5D	93	Capital Letter C With Cedilla Below
5E	94	Capital Letter U With Diaeresis
5F	95	Underline
60	96	Capital Letter G With Breve
61	97	Lowercase a
62	98	Lowercase b
63	99	Lowercase c
64	100	Lowercase d
65	101	Lowercase e
66	102	Lowercase f
67	103	Lowercase g
68	104	Lowercase h
69	105	Lowercase i

Table 53 7-Bit Turkish Character Set

Hex Value	Decimal Code	Symbol Name
6A	106	Lowercase j
6B	107	Lowercase k
6C	108	Lowercase l
6D	109	Lowercase m
6E	110	Lowercase n
6F	111	Lowercase o
70	112	Lowercase p
71	113	Lowercase q
72	114	Lowercase r
73	115	Lowercase s
74	116	Lowercase t
75	117	Lowercase u
76	118	Lowercase v
77	119	Lowercase w
78	120	Lowercase x
79	121	Lowercase y
7A	122	Lowercase z
7B	123	Small Letter s With Cedilla Below
7C	124	Small Letter o With Diaeresis
7D	125	Small Letter c With Cedilla Below
7E	126	Small Letter u With Diaeresis
7F	127	Delete

Table 54 Greek Supplemental Character Set

Hex Value	Decimal Code	Symbol Name
20	32	Reserved for Future Use
21	33	Inverted Exclamation Point
22	34	Cent Sign
23	35	Pound Sign
24	36	Reserved for Future Use
25	37	Yen Sign
26	38	Reserved for Future Use
27	39	Paragraph Sign
28	40	General Currency Sign
29	41	Copyright Sign
2A	42	Feminine Ordinal Indicator
2B	43	Left Angle Quotation Mark
2C	44	Reserved for Future Use
2D	45	Reserved for Future Use
2E	46	Reserved for Future Use
2F	47	Reserved for Future Use
30	48	Degree Sign
31	49	Plus or Minus Sign
32	50	Superscript Two
33	51	Superscript Three
34	52	Reserved for Future Use
35	53	Micro Sign
36	54	Paragraph Sign, Pilcrow
37	55	Middle Dot (Ano Teleia)
38	56	Reserved for Future Use
39	57	Superscript 1
3A	58	Masculine Ordinal Indicator
3B	59	Right Angle Quotation Mark
3C	60	Fraction One Quarter
3D	61	Vulgar Fraction One-Half
3E	62	Reserved for Future Use
3F	63	Inverted Question Mark
40	64	Small Greek Letter Iota with Diaeresis
41	65	Capital Greek Letter Alpha
42	66	Capital Greek Letter Beta
43	67	Capital Greek Letter Gamma
44	68	Capital Greek Letter Delta

Table 54 Greek Supplemental Character Set

Hex Value	Decimal Code	Symbol Name
45	69	Capital Greek Letter Epsilon
46	70	Capital Greek Letter Zeta
47	71	Capital Greek Letter Eta
48	72	Capital Greek Letter Theta
49	73	Capital Greek Letter Iota
4A	74	Capital Greek Letter Kappa
4B	75	Capital Greek Letter Lamda
4C	76	Capital Greek Letter Mu
4D	77	Capital Greek Letter Nu
4E	78	Capital Greek Letter Ksi
4F	79	Capital Greek Letter Omicron
50	80	Reserved for Future Use
51	81	Capital Greek Letter Pi
52	82	Capital Greek Letter Rho
53	83	Capital Greek Letter Sigma
54	84	Capital Greek Letter Tau
55	85	Capital Greek Letter Upsilon
56	86	Capital Greek Letter Phi
57	87	Capital Greek Letter Khi
58	88	Capital Greek Letter Psi
59	89	Capital Greek Letter Omega
5A	90	Small Greek Letter Alpha with Accent
5B	91	Small Greek Letter Epsilon with Accent
5C	92	Small Greek Letter Eta with Accent
5D	93	Small Greek Letter Iota with Accent
5E	94	Reserved for Future Use
5F	95	Small Greek Letter Omicron with Accent
60	96	Small Greek Letter Upsilon with Diaeresis
61	97	Small Greek Letter Alpha
62	98	Small Greek Letter Beta
63	99	Small Greek Letter Gamma
64	100	Small Greek Letter Delta
65	101	Small Greek Letter Epsilon
66	102	Small Greek Letter Zeta
67	103	Small Greek Letter Eta
68	104	Small Greek Letter Theta
69	105	Small Greek Letter Iota

Table 54 Greek Supplemental Character Set

Hex Value	Decimal Code	Symbol Name
6A	106	Small Greek Letter Kappa
6B	107	Small Greek Letter Lambda
6C	108	Small Greek Letter Mu
6D	109	Small Greek Letter Nu
6E	110	Small Greek Letter Ksi
6F	111	Small Greek Letter Omicron
70	112	Reserved for Future Use
71	113	Small Greek Letter Pi
72	114	Small Greek Letter Rho
73	115	Small Greek Letter Sigma
74	116	Small Greek Letter Tau
75	117	Small Greek Letter Upsilon
76	118	Small Greek Letter Phi
77	119	Small Greek Letter Chi
78	120	Small Greek Letter Psi
79	121	Small Greek Letter Omega
7A	122	Small Greek Letter Zeta
7B	123	Small Greek Letter Upsilon with Accent
7C	124	Small Greek Letter Omega with Accent
7D	125	Accent (Tonos)
7E	126	Reserved for Future Use

Table 55 Hebrew Supplemental Character Set

Hex Value	Decimal Code	Symbol Name
20	32	Space
21	33	Inverted Exclamation Mark
22	34	Cent Sign
23	35	Pound Sign
24	36	Reserved for Future Use
25	37	Yen Sign
26	38	Reserved for Future Use
27	39	Section Sign
28	40	General Currency Sign
29	41	Copyright Sign
2A	42	Feminine Ordinal Indicator
2B	43	Left Angle Quotation Mark
2C-2F	44-47	Reserved for Future Use
30	48	Degree Sign
31	49	Plus or Minus Sign
32	50	Superscript Two
33	51	Superscript Three
34	52	Reserved for Future Use
35	53	Micro Sign
36	54	Paragraph Sign, Pilcrow
37	55	Middle Dot
38	56	Reserved for Future Use
39	57	Superscript 1
3A	58	Masculine Ordinal Indicator
3B	59	Right Angle Quotation Mark
3C	60	Fraction One - Quarter Mark
3D	61	Fraction One - Half Mark
3E	62	Reserved for Future Use
3F	63	Inverted Question Mark
40-5F	64-95	Reserved for Future Use
60	96	Hebrew letter ALEPH
61	97	Hebrew letter BETH
62	98	Hebrew letter GIMMEL
63	99	Hebrew letter DALETH
64	100	Hebrew letter HE
65	101	Hebrew letter WAW
66	102	Hebrew letter ZAYIN

Table 55 Hebrew Supplemental Character Set

Hex Value	Decimal Code	Symbol Name
67	103	Hebrew letter HET
68	104	Hebrew letter TETH
69	105	Hebrew letter YOD
6A	106	Hebrew letter KAPH (Final Form)
6B	107	Hebrew letter KAPH
6C	108	Hebrew letter LAMED
6D	109	Hebrew letter MEM (Final Form)
6E	110	Hebrew letter MEM
6F	111	Hebrew letter NUN (Final Form)
70	112	Hebrew letter NUN
71	113	Hebrew letter SAMEKH
72	114	Hebrew letter A'YIN
73	115	Hebrew letter PE (Final Form)
74	116	Hebrew letter PE
75	117	Hebrew letter ZADIK (Final Form)
76	118	Hebrew letter ZADIK
77	119	Hebrew letter KOF/KUF
78	120	Hebrew letter RESH
79	121	Hebrew letter SHIN/SIN
7A	122	Hebrew letter TAF
7B	123	Reserved for Future Use
7C	124	Reserved for Future Use
7D	125	Reserved for Future Use
7E	126	Reserved for Future Use
7F	127	Delete

Table 56 Turkish Supplemental Character Set

Hex Value	Decimal Code	Symbol Name
20	32	Space
21	33	Inverted Exclamation Mark
22	34	Cent Sign
23	35	Pound Sign
24	36	Reserved for Future Use
25	37	Yen Sign
26	38	Reserved for Future Use
27	39	Section Sign
28	40	General Currency Sign
29	41	Copyright Sign
2A	42	Feminine Ordinal Indicator
2B	43	Angle Quotation Mark - Left
2C	44	Reserved for Future Use
2D	45	Reserved for Future Use
2E	46	Capital Letter I With Dot Above
2F	47	Reserved for Future Use
30	48	Degree Sign
31	49	Plus/Minus Sign
32	50	Superscript 2
33	51	Superscript 3
34	52	Reserved for Future Use
35	53	Micro Sign
36	54	Paragraph Sign (Pilcrow)
37	55	Middle Dot
38	56	Reserved for Future Use
39	57	Superscript 1
3A	58	Masculine Ordinal Indicator
3B	59	Angle Quotation Mark (Right)
3C	60	Fraction One-Quarter Mark
3D	61	Fraction One-Quarter Mark
3E	62	Small Letter i Without Dot
3F	63	Inverted Question Mark
40	64	Uppercase A with Grave Accent
41	65	Uppercase A with Acute Accent
42	66	Uppercase A with Circumflex Accent
43	67	Uppercase A with Tilde
44	68	Uppercase A with Diaeresis

Table 56 Turkish Supplemental Character Set

Hex Value	Decimal Code	Symbol Name
45	69	Uppercase A with Ring
46	70	Uppercase AE Diphthong
47	71	Uppercase C with Cedilla
48	72	Uppercase E with Grave
49	73	Uppercase E with Acute
4A	74	Uppercase E with Circumflex Accent
4B	75	Uppercase E with Diaeresis
4C	76	Uppercase I with Grave
4D	77	Uppercase I with Acute
4E	78	Uppercase I with Circumflex Accent
4F	79	Uppercase I with Diaeresis
50	80	Capital Letter G With Breve
51	81	Uppercase N with Tilde
52	82	Uppercase O with Grave
53	83	Uppercase O with Acute
54	84	Uppercase O with Circumflex Accent
55	85	Uppercase O with Tilde
56	86	Uppercase O with Diaeresis
57	87	Uppercase OE Ligature
58	88	Uppercase O with Slash
59	89	Uppercase O with Grave
5A	90	Uppercase U with Acute
5B	91	Uppercase U with Circumflex Accent
5C	92	Uppercase U with Diaeresis or Diaeresis
5D	93	Uppercase Y with Diaeresis
5E	94	Capital Letter S With Cedilla
5F	95	Sharp S
60	96	Lowercase a with Grave
61	97	Lowercase a with Acute
62	98	Lowercase a with Circumflex Accent
63	99	Lowercase a with Tilde
64	100	Lowercase a with Diaeresis
65	101	Lowercase a with Ring
66	102	Lowercase ae Diphthong
67	103	Lowercase c with Cedilla
68	104	Lowercase e with Grave
69	105	Lowercase e with Acute

Table 56 Turkish Supplemental Character Set

Hex Value	Decimal Code	Symbol Name
6A	106	Lowercase e with Circumflex Accent
6B	107	Lowercase e with Diaeresis
6C	108	Lowercase i with Grave
6D	109	Lowercase i with Acute
6E	110	Lowercase i with Circumflex Accent
6F	111	Lowercase i with Diaeresis
70	112	Small Letter g With Breve
71	113	Lowercase n with Tilde
72	114	Lowercase o with Grave
73	115	Lowercase o with Acute
74	116	Lowercase o with Circumflex Accent
75	117	Lowercase o with Tilde
76	118	Lowercase o with Diaeresis
77	119	Lowercase oe Ligature
78	120	Lowercase o with Slash
79	121	Lowercase u with Grave
7A	122	Lowercase u with Acute
7B	123	Lowercase u with Circumflex Accent
7C	124	Lowercase u with Diaeresis
7D	125	Lowercase y with Diaeresis
7E	126	Small Letter s With Cedilla
7F	127	Delete

Building Large Mathematical Symbols

Table 57 shows how to build large mathematical symbols. The characters are designed to connect to adjacent character cells at 10 cpi and 6 lpi to form technical characters that can occupy several vertically adjacent and/or horizontally adjacent character positions.

To use Table 57, find the character you want to build (along the top of the table). On the left side of the table are various pieces of the characters needed to create the whole. Follow the top row choice, say, Integral, all the way down the table. Designate the hex value called out beside the symbol names. For example, to build an oversize integral, you will need a top integral (hex 24), bottom integral (hex 25), and vertical connector (hex 26).

Table 57 Component Characters

Symbol Name/ Hex Value	Radical	Integral	Square Bracket	Curly Bracket	Parenthesis	Summations
Left Radical 21	X					
Top Left Radical 22	X					
Horizontal Connector 23	X					X
Top Integral 24		X				
Bottom Integral 25		X				
Vertical Connector 26	X	X	X	X	X	
Top Left Square Bracket 27			X			
Bottom Left Square Bracket 28			X			
Top Right Square Bracket 29			X			
Bottom Right Square Bracket 2A			X			
Top Left Parenthesis 2B				X	X	
Bottom Left Parenthesis 2C				X	X	
Top Right Parenthesis 2D				X	X	
Bottom Right Parenthesis 2E				X	X	
Left Middle Curly Brace 2F				X		
Right Middle Curly Brace 30				X		
Top Left Summation 31						X
Bottom Left Summation 32						X

Table 57 Component Characters

Symbol Name/ Hex Value	Radical	Integral	Square Bracket	Curly Bracket	Parenthesis	Summations
Top Vertical Summation Connector 33						X
Bottom Vertical Summation Connector 34						X
Top Right Summation 35						X
Bottom Right Summation 36						X
Right Middle Summation 37						X

4 *Bar Codes*

Bar Codes

A bar code is a graphic representation of alphanumeric characters that can be read by a scanning device. This chapter describes how to print bar codes using LG emulation control codes.

In LG emulation, three escape sequences enable the printer to print bar codes. One escape sequence sets the bar code parameters, another starts bar code production, and the third sequence stops bar code printing.

Select Bar Codes Attributes Sequence (DECSBCA)

ASCII Code ESC [P1; P2;...P9q

Hex Code 1B 5B P1 3B P2 3B...P9 27 71

Dec Code 27 91 P1 59 P2 59...P9 39 113

Purpose Selects bar code type and orientation.

Discussion Once defined, bar code parameters remain in effect until:

- A new bar code select parameter sequence is sent
- A reset command returns settings to default values
- On power-up, the default values are set

Bar code parameters are set according to the following choices:

- P1 defines parameters for the various bar code styles:

P1	Function	P1	Function
0/missing	Code 39 (default)	8	Codabar b/n
1	Interleaved 2 of 5	9	Codabar c/*
2	Code 39	10	Codabar d/e
3	Extended Code 39	11	UPC-A
4	EAN-8	12	UPC-E
5	EAN-13	13	Postnet
6	Code 11	14	Code 128
7	Codabar a/t	15	Code 128- UCC

- P2 sets the width for the narrow bars and spaces in units specified by the SSU code.

Default value = 10 pixels = 12 decipoints

Minimum value = 9 pixels = 11 decipoints

This does not apply to all UPC, EAN, and Postnet bar codes.

- P3 sets the width for the quiet zone. The printer's quiet zone is a constant pixel value of 150 pixels (180 decipoints) or ten times the narrow bar, whichever is greater.

This does not apply to all UPC, EAN, and Postnet bar codes.

- P4 sets the width of the wide bars and wide spaces in units specified by the SSU code.

Default value = 2.5 times the value of P2

Minimum value = 2.4 times the narrow bar when the narrow bar is less than or equal to twelve pixels

This does not apply to all UPC, EAN, Code 11, Code 128, and Postnet bar codes.

- P5 sets the intercharacter gap in units specified by the SSU code.

Default value = 136 pixels

This does not apply to the Interleaved 2 of 5 code, or to all UPC, Code 128, EAN, and Postnet bar codes.

- P6 sets the height of bars in units specified by the SSU code.

Minimum value = 144 pixels = 173 decipoints

Default value = 300 pixels = 360 decipoints

- P7 defines the control character encoding character (CCEC). Any character within a range of 2/0 through 7/15 indicates the start of control character encoding. The CCEC is followed by a two-digit hexadecimal number equal to the ASCII value of the character to be encoded. To bar code the ESC character, enter the CCEC, then the ESC character's hexadecimal format. The default is P7 = 0.

P7	Function
0/missing n	No encoding of control characters The decimal ASCII value representing the control character encoding character.

This only applies to Extended Code 39.

- P8 sets the orientation for the bar codes. Bar codes can be rotated to four different positions, though any characters beneath them are printed only in portrait or landscape orientations. The default is P8 = 0.

P8	Function
0/missing	Same as current page orientation
1	Horizontal (portrait)
2	Vertical, rotation of -90° (landscape)
3	Vertical, rotation of +90° (landscape)
4	Horizontal, upside down, rotation of 180°

P9	Function
0/missing	No human-readable characters printed
1	No human-readable characters printed
2	human-readable characters printed in current font
3	human-readable characters printed in OCR-A
4	human-readable characters printed in OCR-B

NOTE: When printing the human-readable line for any rotations other than zero degrees (horizontal portrait mode), the special bar code font is used regardless of how the P9 parameter is set (2, 3, or 4). OCR-A and OCR-B are available only in portrait orientation.

This does not apply to the Postnet bar code.

IMPORTANT If the printer's logical form-length setting **DECSLPP** or **DECSTBM** (or the control panel form length setting) does not match the physical form length of the paper in use, then bar codes located near (on or across) the logical perforation will not print correctly. Make sure that the forms length setting matches the physical form, and do not print bar codes on or across the perforation.

If an illegal parameter sequence is requested, the sequence is ignored and the last bar code parameter remains unchanged.

Start Bar Coding (DECBARC)

ASCII Code ESC % SP 0

Hex Code 1B 25 20 30

Dec Code 27 37 32 48

Purpose Generates bar codes using data that follow the sequence.

Discussion Bar code parameters are defined by the last DECSBCA sequence. The printer continues to encode bar codes until it receives the Stop Bar Code sequence.

The printer begins to generate a bar code at the upper left- hand corner of the left quiet zone and ends at the lower right- hand corner of the right quiet zone. Bar codes that extend beyond the margins are truncated.

Stop Bar Coding (Return from Other Coding System: ROCS)

ASCII Code ESC % @

Hex Code 1B 25 40

Dec Code 27 37 64

Purpose Stops bar code printing.

Discussion Once bar coding is stopped, the font selection and associated attributes are restored to the conditions prevailing prior to bar code printing.

Bar Code Characteristics

The printer supports fifteen bar code styles:

- Code 39 (default or user-selectable settings)
- Extended Code 39
- Interleaved 2 of 5
- EAN 8
- EAN 13
- Code 11
- Codebar a/t
- Codebar b/n
- Codebar c/*
- Codebar d/e
- UPC-A
- UPC-E
- Postnet
- Code 128 - USS (regular)
- Code 128 - UCC (serial shipping container code)

All bar code styles differ, though the differences can be subtle or obvious. The following subsections discuss bar code characteristics that are pertinent to printing readable bar codes.

Number of Bars per Character

Each bar code style is made up of a specific number of light and dark bars. Dark bars are the inked, machine-readable lines; light bars are the unprinted spaces between the dark bars. Several styles of light and dark bar combinations exist. For example:

- In the Code 39 style, both light and dark bars are encoded to define a single character.
- In the Interleaved 2 of 5 style, the light bars decode one character while the dark bars decode another character.

The light bars and dark bars can also be narrow or wide. These width variations are unique to each bar code style.

Bar Code Character Set

Different bar code styles allow certain parts of the ASCII character set to be used. Some styles allow only the numerals 0 - 9, while others allow the full ASCII character set, and still others allow variations in between.

START, STOP, and CENTER Code Characters

The START/STOP characters identify the beginning and end of the bar code symbol to the bar code reader. The START code is at the left end of the symbol, next to the most significant character. The STOP code is at the right end of the symbol, next to the least significant character.

Some bar code styles have a CENTER character code. This code divides the characters so that a digit that appears on both sides of the CENTER code can have a certain bar pattern on the left side that differs from the pattern on the right side. This is possible because the digits to the left of the CENTER character

code are usually coded in odd parity, while the digits to the right of the CENTER bar are coded in even parity.

Quiet Zone

Both ends of the bar code structure require blank quiet zones. The quiet zones should be at least 0.25 inches wide and completely blank to ensure accurate reading of the START/STOP codes and to prevent adjacent bar codes from overlapping. The operator is responsible for providing sufficient space on the form for the quiet zones.

Intercharacter Gap

The intercharacter gap separates the last bar in one character from the first bar of the next character. The intercharacter gap is required in styles where each character begins and ends with a dark bar.

Number of Characters in a Bar Code

There is no set number of characters for all bar codes. Some styles have a specific number of characters necessary for making individual bar codes (for example, UPC-A uses an 11-character symbol). Code 39, however, uses character symbols of variable length.

Checksums

Checksums can be included within the bar code symbol. If a checksum digit is required for a particular style, it is computed by the user and sent along with the rest of the characters that make up the bar code symbol. The printer automatically computes the check digit and embeds it at the end of the bar code for the UPC, EAN, Code 11, Code 128, and Postnet bar codes.

Parity

You can use odd or even parity to send an individual character in styles EAN-8, EAN-13, UPC-A, and UPC-E. The individual digits (0 through 9, since these are the only allowable characters in these styles) might have different bar patterns, depending on whether the character is coded in odd or even parity.

Multiple Bar Codes

The printer can print multiple bar codes on the same line. To do this, use the following sequence:

POSITION	START	Print	Stop	POSITION	Start next	Print	Stop
(VPA)	bar code	bar code	bar code	(VPA)	bar code	bar code	bar code

The above method prints multiple bar codes on one line by means of multiple passes. For example, the printer will print the first bar code, reverse the paper, then print the next bar code on the same line.

The sequence for printing multiple bar codes is shown below, implemented via control codes described on the indicated pages:

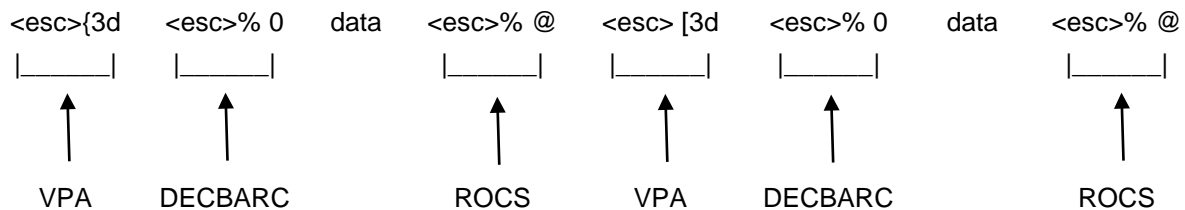

Bar Code Styles

The following sections discuss the bar codes the printer can make. The characteristics of bar code styles, P1 - P9 values, and their defaults are also discussed.

Code 39

In the Code 39 style, there are five dark bars and four light bars for a total of nine bars. Three bars are wide and the other six are narrow. Both light and dark bars are coded to define the character. A narrow light/dark bar is assigned a binary 0 and a wide light/dark bar is assigned a binary 1.

Code 39 has the following characteristics:

- Character set includes ten digits (0 - 9), uppercase letters A - Z, plus eight additional characters (- . \$ / + % SP *)
- START and STOP codes
- No CENTER code
- Definable intercharacter gap
- Variable length characters per complete symbol
- If a checksum is required for bar code readability, you must include it as part of the data.

Extended Code 39

For printable characters, Extended Code 39 prints like Code 39. With control characters, Extended Code 39 decodes and prints the control characters as their combined printable codes. See Table 58 for the Extended Code 39 ASCII character set.

Table 58 Extended Code 39 ASCII Character Set

ASCII	Code 39	ASCII	Code 39	ASCII	Code 39	ASCII	Code 39
NUL	%U	SP	Space	@	%V	`	%W
SOH	\$A	'	/A	A	A	a	+A
STX	\$B		/B	B	B	b	+B
ETX	\$C	#	/C	C	C	c	+C
EOT	\$D	\$	/D	D	D	d	+D
ENQ	\$E	%	/E	E	E	e	+E
ACK	\$F	&	/F	F	F	f	+F
BEL	\$G	'	/G	G	G	g	+G
BS	\$H	(/H	H	H	h	+H
HT	\$I)	/I	I	I	i	I
LF	\$J	*	/J	J	J		+J
VT	\$K	+	/K	K	K	k	+K

Table 58 Extended Code 39 ASCII Character Set

ASCII	Code 39	ASCII	Code 39	ASCII	Code 39	ASCII	Code 39
FF	\$L	,	/L	L	L	l	+L
CR	\$M	--	--	M	M	m	+M
SO	\$N	.	.	N	N	n	+N
SI	\$O	/	/O	O	O	o	+O
DLE	\$P	0	0	P	P	p	+P
DC1	\$Q	1	1	Q	Q	q	+Q
DC2	\$R	2	2	R	R	r	+R
DC3	\$S	3	3	S	S	s	+S
DC4	\$T	4	4	T	T	t	+T
NAK	\$U	5	5	U	U	u	+U
SYN	\$V	6	6	V	V	v	+V
ETB	\$W	7	7	W	W	w	+W
CAN	\$X	8	8	X	X	x	+X
EM	\$Y	9	9	Y	Y	y	+Y
SUB	\$Z	:	/Z	Z	Z	z	+Z
ESC	%A	;	%F	[%K	{	%P
FS	%B	<	%G	\	%L		%Q
GS	%C		%H]	%M	}	%R
RS	%D	>	%I	^	%N	~	%S
US	%E	?	%J	—	%O	DEL	%T %X %Y %Z

Code 11

In the Code 11 style, there are three dark bars and two light bars for a total of five bars. Both light and dark bars are coded to define the character. A narrow light/dark bar is assigned a binary 0 and a wide light/dark bar is assigned a binary 1.

Code 11 has the following characteristics:

- Character set includes ten digits (0 - 9) and the dash (-) character
- START and STOP codes
- No CENTER code
- Definable intercharacter gap
- Variable length characters per complete symbol
- Two checksums are computed automatically and embedded at the end of the bar code. The checksum data is not printed as part of the human- readable data field.

Codabar a/t

Codabar a/t has four dark bars and three light bars for a total of seven bars. Both light and dark bars are coded to define the character. A narrow light/dark bar is assigned a binary 0 and a wide light/dark bar is assigned a binary 1.

Codabar a/t has the following characteristics:

- Character set includes ten digits (0 - 9) plus six characters (- . \$ / + :)
- Illegal characters are not processed and are ignored.
- START and STOP codes
- No CENTER code
- Definable intercharacter gap
- Variable length characters per complete symbol
- If a checksum is required for bar code readability, you must include it as part of the data.

Codabar b/n

Codabar b/n has four dark bars and three light bars for a total of seven bars. Both light and dark bars are coded to define the character. A narrow light/dark bar is assigned a binary 0 and a wide light/dark bar is assigned a binary 1.

Codabar b/n has the following characteristics:

- Character set includes ten digits (0 - 9) plus six characters (: / . + \$ -)
- START and STOP codes
- No CENTER code
- Definable intercharacter gap
- Variable length characters per complete symbol
- If a checksum is required for bar code readability, you must include it as part of the data.

Codabar c/*

Codabar c/* has four dark bars and three light bars for a total of seven bars. Both light and dark bars are coded to define the character. A narrow light/dark bar is assigned a binary 0 and a wide light/dark bar is assigned a binary 1.

Codabar c/* has the following characteristics:

- Character set includes ten digits (0 - 9) plus six characters (: / . + \$ -)
- Illegal characters are not processed and are ignored.
- START and STOP codes
- No CENTER code
- Definable intercharacter gap
- Variable length characters per complete symbol
- If a checksum is required for bar code readability, you must include it as part of the data.

Codabar d/e

Codabar d/e has four dark bars and three light bars for a total of seven bars. Both light and dark bars are coded to define the character. A narrow light/dark bar is assigned a binary 0 and a wide light/dark bar is assigned a binary 1.

Codabar d/e has the following characteristics:

- Character set includes ten digits (0 - 9) plus six characters (: / . + \$ -)
- START and STOP codes
- No CENTER code
- Definable intercharacter gap
- Variable length characters per complete symbol
- If a checksum is required for bar code readability, you must include it as part of the data.

EAN-8

EAN-8 contains two dark bars and two light bars for a total of four bars. Each light and dark bar is 1 - 4 modules wide. A module is the smallest increment that can represent data. Zeros are represented by light modules and ones by dark modules. Each character contains some combination of seven modules that total two dark bars and two light bars.

The above is always true except with the START/STOP and CENTER character codes. The START/STOP character bar pattern consists of two dark bars and one light bar for a total of three bars. The CENTER character bar pattern has two dark bars and three light bars for a total of five bars.

Parameters P2 through P5 and P7 are not applicable and will be ignored. EAN-8 has the following characteristics:

- Ten digit character set (0 - 9)
- START and STOP codes
- CENTER code
- Intercharacter gap not definable

- Fixed length of seven characters per complete symbol. The first digit is the number system code, followed by six digits of data. The printer computes the check digit automatically and embeds it in the bar code as the eighth digit. All eight digits are encoded in the bar code symbol with four digits to the left of the CENTER code in odd parity, and four digits to the right of the CENTER code in even parity.
- If more or less than seven characters are used, or if any of the characters used are illegal, an error message is printed.
- The minimum character height is set at 12 mm, per ISO STD-P6 limitation.

EAN-13

EAN-13 has two dark bars and two light bars for a total of four bars. Each light/dark bar is 1 - 4 modules wide. A module is the smallest increment that can represent data. Zeros are represented by light modules and ones by dark modules. Each character contains some combination of seven modules that total two dark bars and two light bars.

The above is always true except with the START/STOP and CENTER character codes. The START/STOP character bar pattern consists of two dark bars and one light bar for a total of three bars. The CENTER character bar pattern has two dark bars and three light bar for a total of five bars.

Parameters P2 through P5 and P7 are not applicable and will be ignored. EAN-13 has the following characteristics:

- Ten digit character set (0 - 9)
- START and STOP codes
- CENTER code
- Intercharacter gap not definable
- Fixed length of twelve characters per complete symbol. The first digit is the number system code, followed by eleven digits of data, then the check digit. Only twelve of the digits (the second through the thirteenth) are encoded in the bar code symbol with six digits to the left of the CENTER code and six to the right of it. An EAN-13 number can have three different bar patterns depending on its position and number system code. The printer computes the check digit automatically and embeds it in the bar code as the thirteenth digit. All thirteen digits are printable in the human- readable line.
- If more or less than twelve characters are used, or if any of the characters used are illegal, an error message is printed.
- The minimum character height is set at 12 mm, per ISO STD-P6 limitation.

Interleaved 2 of 5

The bar code symbol uses a series of wide and narrow bars and spaces to represent numeric characters. The structure is 2 wide elements (bars or spaces) and 3 narrow elements. In the bar code, two characters are interleaved (paired); bars are used to represent the first character in the pair and spaces are used to represent the second character in the pair.

The above is always true except with the START and STOP character codes. The START character bar pattern consists of two dark bars and two light bars for a total of four bars. The STOP character bar pattern has two dark bars and one light bar for a total of three bars.

This style includes the following characteristics:

- Ten digit character set (0 - 9)
- START and STOP codes

- Illegal characters are not processed and are ignored.
- No CENTER code
- Intercharacter gap not definable
- A variable length of characters per complete symbol. If an odd number of input digits is sent, the printer inserts a leading 0 to the data stream. This encodes in the bar code symbol and prints in the human-readable line.
- If a checksum is required for bar code readability, you must include it as part of the data.

UPC-A

UPC-A has two dark bars and two light bars for a total of four bars. Each light/ dark bar is 1 - 4 modules wide. A module is the smallest increment that can represent data. Zeros are represented by light modules and ones by dark modules. Each character contains some combination of seven modules that total two dark bars and two light bars.

The above is always true except with the START/STOP and CENTER character codes. The START/STOP character bar pattern consists of two dark bars and one light bar for a total of three bars. The CENTER character bar pattern has two dark bars and three light bars for a total of five bars.

Parameters P2 through P5 and P7 are not applicable and are ignored. UCP-A has the following characteristics:

- Ten digit character set (0 - 9)
- START and STOP codes
- CENTER code
- Intercharacter gap not definable
- Fixed length of eleven characters per complete symbol. The first digit is the number system code, usually followed by a five digit vendor number. The next five digits are typically the product number. The printer automatically computes the check digit and embeds it at the end of the bar code. All twelve digits are encoded in the bar code symbol, with six digits to the left of the CENTER code in odd parity and six to the right of the CENTER code with even parity.
- If more or less than eleven characters are used or if any of the characters used are illegal, an error message is printed.

UPC-E

UPC-E has two dark bars and two light bars for a total of four bars. Each light/ dark bar is 1 - 4 modules wide. A module is the smallest increment that can represent data. Zeros are represented by light modules and ones by dark modules. Each character contains some combination of seven modules that total two dark bars and two light bars.

The above is always true except with the START and STOP character codes. The START character bar pattern consists of two dark bars and one light bar for a total of three bars. The STOP character bar pattern has three dark bars and three light bars for a total of six bars.

Parameters P2 through P5 and P7 are not applicable and are ignored. UPC-E has the following characteristics:

- Ten digit character set (0 - 9)
- START and STOP codes
- No CENTER code

- Intercharacter gap not definable
- Fixed length of eleven digits per complete symbol. The first character of the data field is interpreted as the number system code and must always equal 0. The next five digits represent the vendor number and the last five represent the product number.
- If more or less than eleven characters are used or if any of the characters are illegal, an error message is printed.

Six of the eleven digits are encoded into the bar code symbol. These six digits are taken from the eleven digit UPC input code as follows:

- If the vendor number (the first five digits after the number system code) ends in 000, 100, or 200, the product number (the second five digits) must fall between 00000 and 00999. The six digits that make up the bar code symbol are the first two characters of the vendor number, the last three characters of the product number, and the third character of the vendor number, in that order. Therefore, the sequence of digits taken is 1st, 2nd, 8th, 9th, 10th, 3rd.
- If the vendor number ends in 300, 400, 500, 600, 700, 800, or 900, the product number must fall between 00000 and 00099. The six digits that make up the bar code are the first three characters of the vendor number, the last two characters of the product number, then a 3. Therefore, the sequence of digits taken is 1st, 2nd, 3rd, 9th, 10th, 3.
- If the vendor number ends in 10, 20, 30, 40, 50, 60, 70, 80, or 90, the product number must fall between 00000 and 00009. The six digits that make up the bar code symbol are the first four characters of the product number, followed by a 4. Therefore, the sequence of digits taken is 1st, 2nd, 3rd, 4th, 10th, 4.
- If the vendor number does not end in a zero, the product number must fall between 00005 and 00009. The six digits that make up the bar code symbol are all five digits of the vendor number, followed by the product number's last character. Therefore, the sequence of digits taken is 1st, 2nd, 3rd, 4th, 5th, 10th.
- If the digit input does not fall into one of the above four categories, it is considered invalid and an error message is printed.
- The printer computes a modulo 10 checksum digit so that the six digits to be encoded in the bar code symbol are selected correctly. However, the check digit is not encoded as part of the bar code symbol and is not printed in the human-readable line.

Table 59 UPC-E Number Pattern Sequences

If the Vendor Number is:	And the Product Number is:	Then the Encoded UPC-E Bar Code Symbol is:
X X 0 0 0	0 0 0 0 0	X X 0 0 0 0
X X 1 0 0	0 0 0 0 0	X X 0 0 0 1
X X 2 0 0	0 0 9 9 9	X X 9 9 9 2
X X 3 0 0	0 0 0 0 0	X X 3 0 0 3
X X 9 0 0	0 0 0 9 9	X X 9 9 9 3
X X X 1 0	0 0 0 0 0	X X X 1 0 4
X X X 9 0	0 0 0 0 9	X X X 9 9 4
X X X X 1	0 0 0 0 5	X X X X 1 5
X X X X 9	0 0 0 0 9	X X X X 9 9

NOTE: X may range from 0 to 9

Postnet

Print mode text and graphic elements print at different densities. When the two are mixed, a paper reversal can occur because of the different densities.

When the Plot Mode option is set to Enable from the control panel, Postnet barcodes are printed in a Data Processing density (120 x 75 dpi) in the following printing conditions:

1. Printer is currently in print mode.
2. Current density is 120 x 75 dpi.
3. Printer is in the portrait orientation.

Printing in Data Processing density speeds applications which use Postnet barcodes and text. It reduces the chances of reverse motion and improves throughput.

If the Plot Mode option is disabled, Postnet barcodes are printed in a Graphic density (via Plot Mode) as dictated by the DECSGD command.

The Postnet bar code has two tall bars and three short bars for a total of five bars. These five bars represent a numeric digit with valid values from 0 to 9.

The above is always true except with the START/STOP character codes. The START character bar pattern has one tall bar and one space. The STOP character has one space and one tall bar. Parameters P2 through P5, P7, and P9 are not applicable and are ignored. Postnet has the following characteristics:

- Ten digit character set (0 - 9)
- Illegal characters are not processed and are ignored.
- START and STOP codes
- No CENTER code

- Variable length characters per complete symbol
- A checksum is calculated automatically then embedded at the end of the bar code.
- The human-readable data field is not printed.

Code 128 - USS

Code 128 includes three character subsets: A, B, and C. (Code 128-UCC uses subset C only.) All contain the same bar patterns, except for the unique start character that tells the bar code reader which subset is in use. Special characters are available for switching between the subsets in order to generate the shortest possible bar code. (Only subset C is used for 128-UCC, so mode selection is not allowed.)

The Code 128 and 128-UCC structure is shown in and described on the following pages.

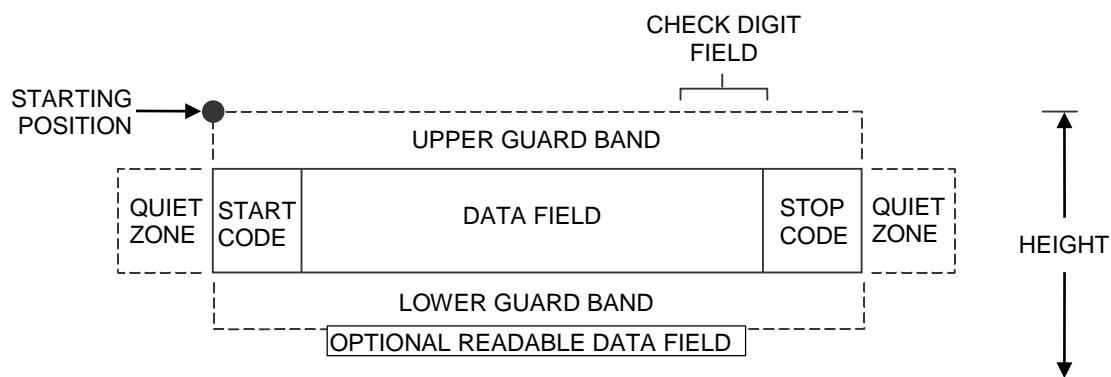

Figure 3 Code 128 Structure

Start/Stop Codes

Code 128 contains special characters which use unique start/stop codes to identify the leading and trailing end of the bar code. In the automatic mode, start and stop codes are generated automatically. In the manual mode, you must supply the start code, but the stop code is generated automatically.

Data Field

Code 128 bar codes support a full ASCII character set: Subset A provides standard alphanumeric keyboard characters, control and special characters; subset B includes all standard alphanumeric keyboard characters, lowercase alphabetical characters, and special characters; subset C provides 100 digit pairs, from 00 to 99 inclusive, plus special characters. Table 60 lists the full Code 128 character set. The “greater than” symbol (>), followed by one of various characters, allows you to manually shift between subsets, specify a particular subset to start with, or to include several non-printable control characters in the data set. (To include the “greater than” symbol itself, you must use >0.) This is described in the Mode Selection section below. The bars and spaces in the printed Code 128 bar code vary in width from 1 to 4 modules. Each character consists of 3 bars and 3 spaces that total 11 modules.

Readable Data

The optional readable data field provides a readable interpretation of the bar code data. Bar code data is printed below the horizontal bar code. The lower guard band is provided when the readable data field is selected. The readable data field is available only in the automatic mode. For 128-UCC, the optional readable data is broken up by spaces to denote 128-UCC data fields.

Check Digit

For Code 128, the modulo-103 check digit is automatically calculated and inserted in the bar code symbol. The check digit verifies accurate scanning. The start code is included in the modulo-103 check digit algorithm.

For 128-UCC, the modulo-10 and 103 check digits are automatically calculated and inserted in the bar code symbol. The check digit verifies accurate scanning.

Code 128 Mode Selection

The printer generates Code 128 bar codes in one of two modes: automatic or manual.

Automatic Mode

The printer creates the shortest possible bar code by automatically sending the subset switch character to switch from subset B into subset C whenever strings of four or more consecutive numeric characters are detected in the input data. As long as the data includes ordinary keyboard characters and no subset switch, the printer switches in and out of subsets B and C automatically before and after numeric character strings. Start codes, stop codes, and check digits are generated automatically.

NOTE: You must use >0 to represent the > character. The printer recognizes >0 as the “greater than” character (>) on a standard ASCII chart.

Manual Mode

Manual mode is selected by inputting a subset switch character (characters preceded by >) anywhere in the bar code data. In the manual mode, you must insert the special codes into the bar code to switch to another subset. When the printer finds a special code in the data, all automatic switching features are suspended, the readable data field option is cancelled, and the printer expects you to provide all special code switching commands. In manual mode, you must supply the start code; if no start code is provided, the printer inserts a subset B start code. Stop codes and check digits are generated automatically in the manual mode. More information about Manual Mode is provided in the following section.

Code 128 Manual Mode Operation

NOTE: In the manual mode, you are responsible for correct implementation of Code 128 in accordance with the Code 128 Standards Manual.

The Code 128 character set is shown in Table 60. The **Alternate** column identifies the special subset switch characters that switch the printer to the manual mode. These > characters are also horizontally aligned with functions also performed in the automatic mode. For example, >/ represents SI in subset A, o in subset B, and value 79 in subset C. Thus, the following commands generate the same bar code using **Alternate** characters, or subsets B or C:

Subset Switch Characters: >7>,>->.>/

Subset C: >576777879

Subset B: >6lmno

Non-ASCII characters are specified by using the subset switch characters (from >1 through >8 in the **Alternate** column on Table 60) which corresponds to your application. The **Value** column is used when manually translating subset B and C bar codes into their briefest form.

NOTE: The subset switch start codes, >5, >6, and >7 have two functions. At the beginning of a line, they start manual mode data in subset C, B, or A, respectively. When these codes are used anywhere in the data other than at the start of a line, they are interpreted as the non-ASCII characters in Table 60.

Subset B and C Switching - In the automatic mode, the printer creates the briefest, most compact bar code by automatically switching from subset B to subset C when necessary. For example, the data LT436682 could be entered directly into a typed bar code command as ESC%0LT436682ESC%@. The printer automatically selects the appropriate start code, and switches to subset C to compact the continuous numeric data characters (436682).

In the manual mode, however, you must specify the start code and all special function codes to switch subsets. For example, to create the same bar code as generated automatically in the previous paragraph (data of LT436682), the subset B start code is entered, followed by the alpha data (LT), and the subset switch character to switch to subset C is entered followed by the continuous numeric characters. A typical bar code command, in the manual mode, for the data is: ESC%0>6LT>5KbrESC%@. The pairs of continuous numeric data were manually translated to subset B, data Kbr, corresponding to the subset C values of 436682, respectively, as shown in Table 60. If the data (LT436682) had been entered directly into the bar code command as ESC%0>6LT>5436682ESC%@ the bar code generated would have been: Start Code B: LT, subset C: 20 19 22 22 24 18, as determined by the value of the individual data characters in Table 60.

NOTE: If a start code is not entered in the manual mode, the printer provides a subset B start code.

Subset A - Subset A operates in the manual mode only. Subset A data characters include mostly normal printable ASCII characters which require no subset switching and can be entered directly. For example, the data ABC123 in subset A is input in the bar code command as: ESC%0>7ABC123ESC%@. Switching to another subset will not generate a shorter bar code.

You can generate non-printable control characters in subset A by:

1. using the subset B lowercase character equivalent from Table 60 (` through ~), which map to NUL through RS; or
2. using the subset switch characters (>1 through >8, or >SP through >/) from the **Alternate** column of Table 60.

Table 60 Code 128 Character Set

Value	Subset A	Subset B	Subset C	Value	Subset A	Subset B	Subset C	Alternate
0	SP	SP	00	54	V	V	54	
1	!	!	01	55	W	W	55	
2	"	"	02	56	X	X	56	
3	#	#	03	57	Y	Y	57	
4	\$	\$	04	58	Z	Z	58	
5	%	%	05	59	[[59	
6	&	&	06	60	\	\	60	
7	'	'	07	61]]	61	
8	((08	62	^	^	62	
9))	09	63	—	—	63	
10	*	*	10	64	NUL	`	64	>SP
11	+	+	11	65	SOH	a	65	>!
12	,	,	12	66	STX	b	66	>"
13	-	-	13	67	ETX	c	67	>#
14	.	.	14	68	EOT	d	68	>\$
15	/	/	15	69	ENQ	e	69	>%
16	0	0	16	70	ACK	f	70	>&
17	1	1	17	71	BEL	g	71	>'
18	2	2	18	72	BS	h	72	>(

Table 60 Code 128 Character Set

Value	Subset A	Subset B	Subset C	Value	Subset A	Subset B	Subset C	Alternate
19	3	3	19	73	HT	i	73	>)
20	4	4	20	74	LF	j	74	>*
21	5	5	21	75	VT	k	75	>+
22	6	6	22	76	FF	l	76	>,
23	7	7	23	77	CR	m	77	>-
24	8	8	24	78	SO	n	78	>.
25	9	9	25	79	SI	o	79	>/
26	:	:	26	80	DLE	p	80	
27	;	;	27	81	DC1	q	81	
28	<	<	28	82	DC2	r	82	
29	=	=	29	83	DC3	s	83	
30	>	>	30	84	DC4	t	84	
31	?	?	31	85	NAK	u	85	
32	@	@	32	86	SYN	v	86	
33	A	A	33	87	ETB	w	87	
34	B	B	34	88	CAN	x	88	
35	C	C	35	89	EM	y	89	
36	D	D	36	90	SUB	z	90	
37	E	E	37	91	ESC	{	91	
38	F	F	38	92	FS		92	
39	G	G	39	93	GS	}	93	
40	H	H	40	94	RS	~	94	
41	I	I	41	95	US	DEL	95	>1
42	J	J	42	96	FNC3	FNC3	96	>2
43	K	K	43	97	FNC2	FNC2	97	>3
44	L	L	44	98	SHIFT	SHIFT	98	>4
45	M	M	45	99	CODE C	CODE C	99	>5
46	N	N	46	100	CODE B	FNC4	CODE B	>6
47	O	O	47	101	FNC4	CODE A	CODE A	>7
48	P	P	48	102	FNC1	FNC1	FNC1	>8
49	Q	Q	49	103	START CODE A*			>7
50	R	R	50	104	START CODE B*			>6
51	S	S	51	105	START CODE C*			>5
52	T	T	52					
53	U	U	53					

* Used at the beginning of manual mode commands.

Code 128 Examples

The following commands generate the horizontal default ratio Code 128 bar code below in the automatic mode. In the Start Bar Code sequence (DECBARC), SP represents the ASCII space character (hex 20).

ESC[14;;;;;;;;;2'q

ESC%SP0ABC123456ESC%@



ABC123456

The following command generated the Code 128 bar code below in the automatic mode using data of 22446688ABC123456. The bar code data begins in subset B and automatically switches to subset C for the numeric data. In the Start Bar Code sequence (DECBARC), SP represents the ASCII space character (hex 20).

ESC[14;;;;;;;;;2'q

ESC%SP022446688ABC123456ESC%@



22446688ABC123456

The command below generates the following vertical Code 128 bar code with data of 123@25% in manual mode, subset A. In the Start Bar Code sequence (DECBARC), SP represents the ASCII space character (hex 20).

ESC[14;;;;;;;;;2;'q

ESC%SP0>7123@25%ESC%@

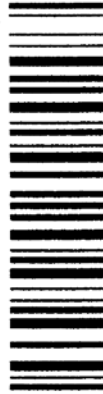

The command below generates the same vertical Code 128 bar code in the automatic mode, subset B. Because less than 4 consecutive numeric digits were provided in the data, no subset switching occurred, and the bar code remained in subset B. In the Start Bar Code sequence (DECBARC), SP represents the ASCII space character (hex 20).

ESC[14;;;;;;;;;2;'q

ESC%SP0123@25%ESC%@



Code 128 - UCC

The 128-UCC Serial Shipping Container Code is a restricted subset of the Code 128-USS standard. It is used as a standard for labeling shipping containers.

The 128-UCC Serial Shipping Container Code has the following parts:

- **Start Code** - The 128-UCC Serial Shipping Container Code consists of numeric data only, so the start code is always Start-C. This is followed by the function code 1 character, which is part of the 128-UCC standard. These are automatically generated by the printer.
- **Qualifier** - This 2-digit number helps identify the symbol as a 128-UCC Serial Shipping Container Code. It is always 00, and uses one character subset C symbol. This is automatically generated by the printer.
- **Data** - 17 numbers you choose to describe a particular shipping container. These are the only numbers that you need to specify; the printer generates the other elements of the bar code automatically.
- **Check Characters** - The 128-UCC Serial Shipping Container Code uses two check characters. The first is a modulo 10 check digit generated from your input data, and printed in human-readable characters. The second is the normal Code 128 modulo 103 check character. The printer calculates both of these numbers automatically.
- **Stop Code** - This is the normal stop code used in the Code 128 bar code. This character is automatically generated by the printer.

Code 128-UCC Example

A Code 128-UCC bar code created on the printer is shown below. The label data are **11223344556677889**. The DESBCA sequence selects UCC-128 with P1 = 15 and P9 = 2 for human readable characters. The DECBARC command starts the bar coding, and ROCS stops the bar coding. Notice that the printer automatically generated the start code, the qualifier, the check digits, and the stop code.

ESC[15;;;;;;;;;;2`q

ESC%SP011223344556677889ESC%@

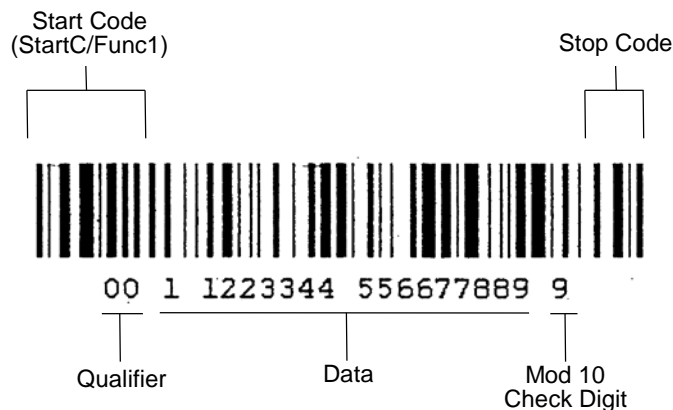

Density and Spacing Between Bar Codes

The following subsections describe the spacing between different combinations of horizontal and vertical spacings between the bar codes.

Horizontal Bar Codes (0 and 180 Degree Rotation)

The width of a horizontal bar code is a function of the number of characters in the bar code symbol, the style of the bar code symbol, and the ratio of wide light/dark bars to narrow light/dark bars. The bar code height is specified as a parameter where the default is 0.75 inches. The human-readable line is not included. If the human-readable line is printed, a gap of 0.1 inch is inserted between the bottom of the bar code symbol and the human-readable line. The human-readable line is printed below the bar code symbol.

Horizontal bar codes (0 and 180 degree rotation), are printed at 100 dots per inch (dpi) horizontally and 100 dpi vertically.

Horizontal Spacing Between Horizontal Bar Codes

A 0.25 inch leading space always appears before a bar code symbol and a 0.25 inch trailing space is inserted after a bar code symbol for a total of 0.5 inches of space between any two bar codes. The leading and trailing spaces are called quiet zones.

Three delimiters are allowed for all bar code styles:

- Space character (20H), except for bar code 39
- Comma character (2CH)
- Horizontal tab character (09H)

The space character adds an extra 0.1 inches of white space between the bar code, the comma adds no extra white space, and the horizontal tab adds the amount set by the tabs. This additional white space is added to the 0.5 inches of the quiet zones that separate the two bar codes.

The horizontal limit is specified by the width of the paper, typically 13.2 inches. Therefore, the width of the encoded bar code symbol plus any spacing between two or more symbols cannot exceed 13.2 inches. If a bar code symbol exceeds the right margin, the printable portion is printed and the remainder is truncated.

Vertical Spacing Between Horizontal Bar Codes

The vertical limit is equal to the maximum allowable height for a bar code symbol: 10 inches. If the human-readable line is printed, then a 0.1 inch gap plus character size is added to compute a total vertical distance.

If the human-readable line is printed, a space the size of the intercharacter gap exists between the human-readable line and the top of the bar code symbol on the next line, plus any linefeeds you have specified.

If there is no human-readable line, the vertical spacing is dependent on the user for how many linefeeds have been specified.

Vertical Bar Codes (90 and 270 Degree Rotation)

The width of the rotated bar code is close in size to the height of the original horizontal bar code (they are not quite the same since the density changes). If the human-readable line is printed, it is accounted for in the total horizontal distance travelled.

The vertical height of the rotated bar code includes the 0.25 inch leading space, the light and dark bars that comprise the bar code symbol, and the 0.25 inch trailing space.

Vertical bar codes are printed with a horizontal density of 100 DPI and a vertical density of 100 DPI.

Horizontal Spacing Between Vertical Bar Codes

The horizontal limit is the width of the paper (or 13.2 inches). The following equation applies with rotated bar codes, where N equals the number of bar code symbols to be printed and HEIGHT equals the height parameter entered for the original bar code:

$(N) * (\text{HEIGHT}) + \text{any spacing between two or more symbols}$ must be less than or equal to 13.2 inches

Ensure proper horizontal spacing between two vertical bar codes. Note that the leading and trailing spaces rotate with the vertical bar codes.

The space character (20H) and the horizontal tab character (09H) produce the white spaces horizontally across the page, just as they do for the horizontal bar codes. The comma delimiter does not separate bar code symbols on the paper. Therefore, if a line of input is rotated with the comma as the delimiter, the bar code symbols are printed one against another. You must use either the space character (20 hex) or the horizontal tab character (09 hex) to keep this from occurring.

If a human-readable line is printed, its 0.1 inch gap is computed into the total horizontal distance.

Vertical Spacing Between Vertical Bar Codes

Vertical spacing is achieved via user-supplied linefeeds.

The vertical limit of any vertical bar code (90 or 270 degree rotation) is the current forms length. The encoded bar code symbols, including quiet zones, must be less than or equal to the current printable forms length for a given line of ASCII input.

If paper length is exceeded during printing, the bar code symbol prints as far as possible, then terminates.

A ***LG Emulation Character Sets***

Introduction

This appendix contains character address charts for the LG emulation which are available with the DEC LG Emulation printer. The first two tables show the character sets available in the Proprinter emulation mode. They can be selected at the control panel or by control codes from the host computer.

These character sets are not available in LG emulation. The LG character sets are available only in LG emulation mode.

The LG Emulation Languages Substitution Table (page 177) identifies specific character substitutions available in the selected language. For example, if you select the U.S. ASCII character set, 023 hex represents the number sign (#). If you then select DEC Dutch, 023 hex represents the English pound symbol (£) instead of the number sign. For each language, only the characters that may differ from the ASCII character set are shown. If a character is not shown on the LG Emulation Languages Substitution Table, it is the same as in the ASCII character set.

LG Emulation Character Set Charts

The following languages comprise the multinational character sets. These languages are only available in the LG emulation. Included are the following:

- U.S. ASCII
- DEC British
- DEC Dutch
- DEC Finnish
- French
- DEC French (Canadian)
- German
- Italian
- JIS Roman
- DEC Norwegian/Danish
- Spanish
- DEC Swedish
- ISO Norwegian/Danish
- DEC Portuguese

The LG Emulation Languages Substitution Table (page 177) identifies specific character substitutions available in the selected language. Hex addresses not shown on the substitution tables use the character in the hex address shown on the standard character set matrix.

US ASCII Character Set

BITS B7 B6 B5 B4 B3 B2 B1	ROW	0 0 0		0 0 1		0 1 0		0 1 1		1 0 0		1 0 1		1 1 0		1 1 1	
		COLUMN		1		2		3		4		5		6		7	
		0	1	2	3	4	5	6	7								
0 0 0 0	0	NUL	0 0 0	DLE	20 16 10	SP	40 32 20	0	60 48 30	@	100 64 40	P	120 80 50	`	140 96 60	p	160 112 70
0 0 0 1	1	SOH	1 1 1	DC1 (XON)	21 17 11	!	41 33 21	1	61 49 31	A	101 65 41	Q	121 81 51	a	141 97 61	q	161 113 71
0 0 1 0	2	STX	2 2 2	DC2	22 18 12	"	42 34 22	2	62 50 32	B	102 66 42	R	122 82 52	b	142 98 62	r	162 114 72
0 0 1 1	3	ETX	3 3 3	DC3 (XOFF)	23 19 13	#	43 35 23	3	63 51 33	C	103 67 43	S	123 83 53	c	143 99 63	s	163 115 73
0 1 0 0	4	EOT	4 4 4	DC4	24 20 14	\$	44 36 24	4	64 52 34	D	104 68 44	T	124 84 54	d	144 100 64	t	164 116 74
0 1 0 1	5	ENQ	5 5 5	NAK	25 21 15	%	45 37 25	5	65 53 35	E	105 69 45	U	125 85 55	e	145 101 65	u	165 117 75
0 1 1 0	6	ACK	6 6 6	SYN	26 22 16	&	46 38 26	6	66 54 36	F	106 70 46	V	126 86 56	f	146 102 66	v	166 118 76
0 1 1 1	7	BEL	7 7 7	ETB	27 23 17	'	47 39 27	7	67 55 37	G	107 71 47	W	127 87 57	g	147 103 67	w	167 119 77
1 0 0 0	8	BS	10 8 8	CAN	30 24 18	(50 40 28	8	70 56 38	H	110 72 48	X	130 88 58	h	150 104 68	x	170 120 78
1 0 0 1	9	HT	11 9 9	EM	31 25 19)	51 41 29	9	71 57 39	I	111 73 49	Y	131 89 59	i	151 105 69	y	171 121 79
1 0 1 0	10	LF	12 10 0A	SUB	32 26 1A	*	52 42 2A	:	72 58 3A	J	112 74 4A	Z	132 90 5A	j	152 106 6A	z	172 122 7A
1 0 1 1	11	VT	13 11 0B	ESC	33 27 1B	+	53 43 2B	;	73 59 3B	K	113 75 4B	[133 91 5B	k	153 107 6B	{	173 123 7B
1 1 0 0	12	FF	14 12 0C	FS	34 28 1C	,	54 44 2C	<	74 60 3C	L	114 76 4C	\	134 92 5C	l	154 108 6C		174 124 7C
1 1 0 1	13	CR	15 13 0D	GS	35 29 1D	-	55 45 2D	=	75 61 3D	M	115 77 4D]	135 93 5D	m	155 109 6D	}	175 125 7D
1 1 1 0	14	SO	16 14 0E	RS	36 30 1E	.	56 46 2E	>	76 62 3E	N	116 78 4E	^	136 94 5E	n	156 110 6E	~	176 126 7E
1 1 1 1	15	SI	17 15 0F	US	37 31 1F	/	57 47 2F	?	77 63 3F	O	117 79 4F	_	137 95 5F	o	157 111 6F	DEL	177 127 7F

Note: The character examples provided herein are representative and not exact replications generated by the printer. All characters are shown in 10 cpi; not all characters are available in all print modes.

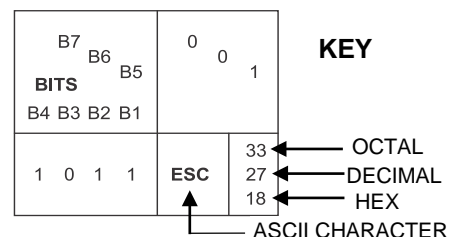

DEC Multinational Character Set

BITS B8 B7 B6 B5 B4 B3B2 B1		7-bit mode or bit 8 set to zero																	
		COLUMN		0		1		2		3		4		5		6		7	
		0	1	0	1	0	1	0	1	0	1	0	1	0	1	0	1	0	1
ROW	0	1	2	3	4	5	6	7	8	9	10	11	12	13	14	15			
0 0 0 0	0	NUL			SP			0	@	P	,	p							
0 0 0 1	1		DC1 (XON)	!			1	A	Q	a	q								
0 0 1 0	2			"			2	B	R	b	r								
0 0 1 1	3		DC3 (XOFF)	#			3	C	S	c	s								
0 1 0 0	4	EOT		\$			4	D	T	d	t								
0 1 0 1	5			%			5	E	U	e	u								
0 1 1 0	6			&			6	F	V	f	v								
0 1 1 1	7			'			7	G	W	g	w								
1 0 0 0	8	BS	CAN	(8	H	X	h	x								
1 0 0 1	9	HT)			9	I	Y	i	y								
1 0 1 0	10	LF	SUB	*	:		J	Z	j	z									
1 0 1 1	11	VT	ESC	+	;		K	[k	{									
1 1 0 0	12	FF		,	<		L	\	l										
1 1 0 1	13	CR		-	=		M]	m	}									
1 1 1 0	14	SO		.	>		N	^	n	~									
1 1 1 1	15	SI		/	?		O	_	o	DEL									

Note: The character examples provided herein are representative and not exact replications generated by the printer. All characters are shown in 10 cpi; not all characters are available in all print modes.

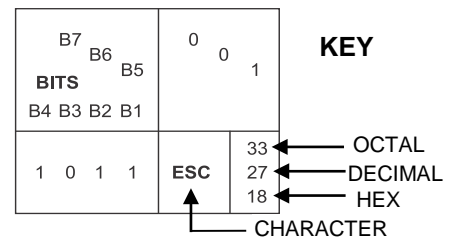

Columns 8 and 9 can be converted to 7-bit Escape sequences. Columns 10 thru 15 are only accessed in 8-bit mode.

1 0 0 0		1 0 0 1		1 0 1 0		1 0 1 1		1 1 0 0		1 1 0 1		1 1 1 0		1 1 1 1	
8		9		10		11		12		13		14		15	
	200 128 80	DCS	220 144 90	(Not Used)	240 160 A0	5	260 176 B0	À	300 192 C0		320 208 D0	à	340 224 E0		360 240 F0
	201 129 81		221 145 91	ì	241 161 A1	±	261 177 B1	Á	301 193 C1	Ñ	321 209 D1	á	341 225 E1	ñ	361 241 F1
	202 130 82		222 146 92	ç	242 162 A2	2	262 178 B2	Â	302 194 C2	Ò	322 210 D2	â	342 226 E2	ò	362 242 F2
	203 131 83		223 147 93	£	243 163 A3	3	263 179 B3	Ã	303 195 C3	Ó	323 211 D3	ã	343 227 E3	ó	363 243 F3
IND	204 132 84		224 148 94		244 164 A4		264 180 B4	Ä	304 196 C4	Ô	324 212 D4	ä	344 228 E4	ô	364 244 F4
NEL	205 133 85		225 149 95	¥	245 165 A5	μ	265 181 B5	Å	305 197 C5	Õ	325 213 D5	å	345 229 E5	õ	365 245 F5
	206 134 86		226 150 96		246 166 A6	¶	266 182 B6	Æ	306 198 C6	Ö	326 214 D6	æ	346 230 E6	ö	366 246 F6
	207 135 87		227 151 97	§	247 167 A7	w	267 183 B7	Ç	307 199 C7	*	327 215 D7	ç	347 231 E7	*	367 247 F7
HTS	210 136 88		230 152 98	ª	250 168 A8		270 184 B8	È	310 200 C8	Ø	330 216 D8	è	350 232 E8	ø	370 248 F8
	211 137 89		231 153 99	W	251 169 A9	1	271 185 B9	É	311 201 C9	Ù	331 217 D9	é	351 233 E9	ù	371 249 F9
VTS	212 138 8A		232 154 9A	a	252 170 AA	o	272 186 BA	Ê	312 202 CA	Ú	332 218 DA	ê	352 234 EA	ú	372 250 FA
PLD	213 139 8B	CSI	233 155 9B	<<	253 171 AB	>>	273 187 BB	Ë	313 203 CB	Û	333 219 DB	ë	353 235 EB	û	373 251 FB
PLU	214 140 8C	ST	234 156 9C		254 172 AC	¼	274 188 BC	Ì	314 204 CC	Ü	334 220 DC	ì	354 236 EC	ü	374 252 FC
RI	215 141 8D		235 157 9D		255 173 AD	½	275 189 BD	Í	315 205 CD	Ý	335 221 DD	í	355 237 ED	ÿ	375 253 FD
SS2	216 142 8E		236 158 9E		256 174 AE		276 190 BE	Î	316 206 CE		336 222 DE	î	356 238 EE		376 254 FE
SS3	217 143 8F		237 159 9F		257 175 AF	¿	277 191 BF	Ï	317 207 CF	β	337 223 DF	ï	357 239 EF	(Not Used)	377 255 FF

← Additional Control Codes → ← DEC SUPPLEMENTAL CHARACTER SET →

Note: The character examples provided herein are representative and not exact replications generated by the printer. all characters are shown in 10 cpi; not all characters are available in all print modes.

Each shaded box will print as a reverse question mark ¿

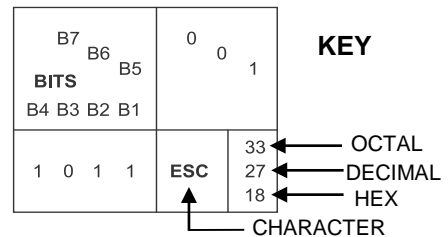

LG Emulation Languages Substitution Table

Hex Address												
LANGUAGE	0023	0040	005B	005C	005D	005E	005F	0060	007B	007C	007D	007E
U.S. ASCII	#	@	[\]	^	-	`	{		}	~
Great Britain	£	@	[\]	^	-	`	{		}	~
French	£	à	5	ç	§	^	-	`	é	ù	è	..
German	#	§	Ä	Ö	Ü	^	-	`	ä	ö	ü	ß
Italian	£	§	5	ç	é	^	-	ù	à	ò	è	ì
JIS Roman	#	@	[¥]	^	-	`	{		}	~
Spanish	£	§	i	Ñ	¿	^	-	`	5	ñ	ç	~
Digital Dutch	£	¼	ÿ	½		^	-	`	..	*	¼	`
Digital Finnish	#	@	Ä	Ö	Å	Ü	-	é	ä	ö	å	ü
Digital French Canadian	#	à	â	ç	ê	î	-	ô	é	ù	è	û
Digital Norwegian/Danish	#	Ä	Æ	Ø	Å	Ü	-	ä	æ	ø	å	ü
Digital Portuguese	#	@	Ã	Ç	Õ	^	-	`	ã	ç	õ	~
Digital Swiss	ù	à	é	ç	ê	î	è	ô	ä	ö	ü	û
Digital Swedish	#	É	Ä	Ö	Å	Ü	-	é	ä	ö	å	ü
ISO Norwegian/Danish	#	@	Æ	Ø	Å	^	-	`	æ	ø	å	~

LG Emulation 94-Character Sets

The following pages show the 94-Character Set charts (also referred to as code pages) for the LG emulation. The character sets are shown in Near Letter Quality (NLQ) print mode. These character sets may be selected using the configuration menus, described in the *Setup Guide*.

U.S. ASCII

U.S. ASCII									
	GL	0	1	2	3	4	5	6	7
	GR	8	9	A	B	C	D	E	F
0					0	@	P	`	p
1				!	1	A	Q	a	q
2				"	2	B	R	b	r
3				#	3	C	S	c	s
4				\$	4	D	T	d	t
5				%	5	E	U	e	u
6				&	6	F	V	f	v
7				'	7	G	W	g	w
8				(8	H	X	h	x
9)	9	I	Y	i	y
A				*	:	J	Z	j	z
B				+	;	K	[k	{
C				,	<	L	\	l	
D				-	=	M]	m	}
E				.	>	N	^	n	~
F				/	?	O	_	o	

DEC Finnish

DEC Finnish									
	GL	0	1	2	3	4	5	6	7
	GR	8	9	A	B	C	D	E	F
0					0	@	P	é	p
1				!	1	A	Q	a	q
2				“	2	B	R	b	r
3				#	3	C	S	c	s
4				\$	4	D	T	d	t
5				%	5	E	U	e	u
6				&	6	F	V	f	v
7				´	7	G	W	g	w
8				(8	H	X	h	x
9)	9	I	Y	i	y
A				*	:	J	Z	j	z
B				+	;	K	Ä	k	ä
C				,	<	L	Ö	l	ö
D				-	=	M	Å	m	á
E				.	>	N	Ü	n	ü
F				/	?	O	_	o	

French

French									
	GL	0	1	2	3	4	5	6	7
	GR	8	9	A	B	C	D	E	F
0					0	à	P	`	p
1				!	1	A	Q	a	q
2				“	2	B	R	b	r
3				£	3	C	S	c	s
4				\$	4	D	T	d	t
5				%	5	E	U	e	u
6				&	6	F	V	f	v
7				´	7	G	W	g	w
8				(8	H	X	h	x
9)	9	I	Y	i	y
A				*	:	J	Z	j	z
B				+	;	K	°	k	é
C				,	<	L	Ç	l	ù
D				-	=	M	§	m	è
E				.	>	N	^	n	“
F				/	?	O	_	o	

DEC French Canadian

DEC French Canadian									
	GL	0	1	2	3	4	5	6	7
	GR	8	9	A	B	C	D	E	F
0					0	à	P	ô	p
1				!	1	A	Q	a	q
2				“	2	B	R	b	r
3				#	3	C	S	c	s
4				\$	4	D	T	d	t
5				%	5	E	U	e	u
6				&	6	F	V	f	v
7				´	7	G	W	g	w
8				(8	H	X	h	x
9)	9	I	Y	i	y
A				*	:	J	Z	j	z
B				+	;	K	â	k	é
C				,	<	L	ç	l	ù
D				-	=	M	ê	m	è
E				.	>	N	î	n	û
F				/	?	O	_	o	

German

German									
	GL	0	1	2	3	4	5	6	7
	GR	8	9	A	B	C	D	E	F
0					0	§	P	`	p
1				!	1	A	Q	a	q
2				“	2	B	R	b	r
3				#	3	C	S	c	s
4				\$	4	D	T	d	t
5				%	5	E	U	e	u
6				&	6	F	V	f	v
7				´	7	G	W	g	w
8				(8	H	X	h	x
9)	9	I	Y	i	y
A				*	:	J	Z	j	z
B				+	;	K	Ä	k	ä
C				,	<	L	Ö	l	ö
D				-	=	M	Ü	m	ü
E				.	>	N	^	n	ß
F				/	?	O	_	o	

Italian

Italian									
	GL	0	1	2	3	4	5	6	7
	GR	8	9	A	B	C	D	E	F
0					0	§	P	ù	p
1				!	1	A	Q	a	q
2				“	2	B	R	b	r
3				£	3	C	S	c	s
4				\$	4	D	T	d	t
5				%	5	E	U	e	u
6				&	6	F	V	f	v
7				´	7	G	W	g	w
8				(8	H	X	h	x
9)	9	I	Y	i	y
A				*	:	J	Z	j	z
B				+	;	K	°	k	à
C				,	<	L	Ç	l	ò
D				-	=	M	é	m	è
E				.	>	N	^	n	ì
F				/	?	O	_	o	

JIS Roman

JIS Roman									
	GL	0	1	2	3	4	5	6	7
	GR	8	9	A	B	C	D	E	F
0					0	@	P	`	p
1				!	1	A	Q	a	q
2				“	2	B	R	b	r
3				#	3	C	S	c	s
4				\$	4	D	T	d	t
5				%	5	E	U	e	u
6				&	6	F	V	f	v
7				´	7	G	W	g	w
8				(8	H	X	h	x
9)	9	I	Y	i	y
A				*	:	J	Z	j	z
B				+	;	K	[k	{
C				,	<	L	¥	l	
D				-	=	M]	m	}
E				.	>	N	^	n	~
F				/	?	O	_	o	

DEC Norwegian/Danish

DEC Norwegian/Danish									
	GL	0	1	2	3	4	5	6	7
	GR	8	9	A	B	C	D	E	F
0					0	Ä	P	ä	p
1				!	1	A	Q	a	q
2				"	2	B	R	b	r
3				#	3	C	S	c	s
4				\$	4	D	T	d	t
5				%	5	E	U	e	u
6				&	6	F	V	f	v
7				'	7	G	W	g	w
8				(8	H	X	h	x
9)	9	I	Y	i	y
A				*	:	J	Z	j	z
B				+	;	K	Æ	k	æ
C				,	<	L	Ø	l	ø
D				-	=	M	Å	m	å
E				.	>	N	Ü	n	ü
F				/	?	O	_	o	

Spanish

Spanish									
	GL	0	1	2	3	4	5	6	7
	GR	8	9	A	B	C	D	E	F
0					0	§	P	`	p
1				!	1	A	Q	a	q
2				“	2	B	R	b	r
3				£	3	C	S	c	s
4				\$	4	D	T	d	t
5				%	5	E	U	e	u
6				&	6	F	V	f	v
7				´	7	G	W	g	w
8				(8	H	X	h	x
9)	9	I	Y	i	y
A				*	:	J	Z	j	z
B				+	;	K	i	k	°
C				,	<	L	Ñ	l	ñ
D				–	=	M	¿	m	ç
E				.	>	N	^	n	~
F				/	?	O	_	o	

DEC Swedish

DEC Swedish									
	GL	0	1	2	3	4	5	6	7
	GR	8	9	A	B	C	D	E	F
0					0	É	P	é	p
1				!	1	A	Q	a	q
2				“	2	B	R	b	r
3				#	3	C	S	c	s
4				\$	4	D	T	d	t
5				%	5	E	U	e	u
6				&	6	F	V	f	v
7				´	7	G	W	g	w
8				(8	H	X	h	x
9)	9	I	Y	i	y
A				*	:	J	Z	j	z
B				+	;	K	Ä	k	ä
C				,	<	L	Ö	l	ö
D				-	=	M	Å	m	å
E				.	>	N	Ü	n	ü
F				/	?	O	_	o	

DEC Great Britain

DEC Great Britain									
	GL	0	1	2	3	4	5	6	7
	GR	8	9	A	B	C	D	E	F
0					0	@	P	`	p
1				!	1	A	Q	a	q
2				"	2	B	R	b	r
3				£	3	C	S	c	s
4				\$	4	D	T	d	t
5				%	5	E	U	e	u
6				&	6	F	V	f	v
7				'	7	G	W	g	w
8				(8	H	X	h	x
9)	9	I	Y	i	y
A				*	:	J	Z	j	z
B				+	;	K	[k	{
C				,	<	L	\	l	
D				-	=	M]	m	}
E				.	>	N	^	n	~
F				/	?	O	_	o	

ISO Norwegian/Danish

ISO Norwegian/Danish									
	GL	0	1	2	3	4	5	6	7
	GR	8	9	A	B	C	D	E	F
0					0	@	P	`	p
1				!	1	A	Q	a	q
2				"	2	B	R	b	r
3				#	3	C	S	c	s
4				\$	4	D	T	d	t
5				%	5	E	U	e	u
6				&	6	F	V	f	v
7				'	7	G	W	g	w
8				(8	H	X	h	x
9)	9	I	Y	i	y
A				*	:	J	Z	j	z
B				+	;	K	Æ	k	æ
C				,	<	L	Ø	l	ø
D				-	=	M	Å	m	å
E				.	>	N	^	n	~
F				/	?	O	_	o	

DEC Dutch

DEC Dutch									
	GL	0	1	2	3	4	5	6	7
	GR	8	9	A	B	C	D	E	F
0					0	¼	P	`	p
1				!	1	A	Q	a	q
2				“	2	B	R	b	r
3				£	3	C	S	c	s
4				\$	4	D	T	d	t
5				%	5	E	U	e	u
6				&	6	F	V	f	v
7				´	7	G	W	g	w
8				(8	H	X	h	x
9)	9	I	Y	i	y
A				*	:	J	Z	j	z
B				+	;	K	ÿ	k	“
C				,	<	L	½	l	<i>f</i>
D				–	=	M		m	¼
E				.	>	N	^	n	´
F				/	?	O	_	o	

DEC Swiss

DEC Swiss									
	GL	0	1	2	3	4	5	6	7
	GR	8	9	A	B	C	D	E	F
0					0	à	P	ô	p
1				!	1	A	Q	a	q
2				“	2	B	R	b	r
3				ù	3	C	S	c	s
4				\$	4	D	T	d	t
5				%	5	E	U	e	u
6				&	6	F	V	f	v
7				´	7	G	W	g	w
8				(8	H	X	h	x
9)	9	I	Y	i	y
A				*	:	J	Z	j	z
B				+	;	K	é	k	ä
C				,	<	L	ç	l	ö
D				-	=	M	ê	m	ü
E				.	>	N	î	n	û
F				/	?	O	è	o	

DEC Portuguese

DEC Portuguese									
	GL	0	1	2	3	4	5	6	7
	GR	8	9	A	B	C	D	E	F
0					0	@	P	`	p
1				!	1	A	Q	a	q
2				"	2	B	R	b	r
3				#	3	C	S	c	s
4				\$	4	D	T	d	t
5				%	5	E	U	e	u
6				&	6	F	V	f	v
7				'	7	G	W	g	w
8				(8	H	X	h	x
9)	9	I	Y	i	y
A				*	:	J	Z	j	z
B				+	;	K	Ã	k	ã
C				,	<	L	Ç	l	ç
D				-	=	M	Õ	m	õ
E				.	>	N	^	n	~
F				/	?	O	_	o	

VT100 Graphics

VT100 Graphics									
	GL	0	1	2	3	4	5	6	7
	GR	8	9	A	B	C	D	E	F
0					0	@	P	◆	-
1				!	1	A	Q	■	-
2				"	2	B	R	♣	-
3				#	3	C	S	♠	-
4				\$	4	D	T	♣	†
5				%	5	E	U	♣	†
6				&	6	F	V	°	⊥
7				'	7	G	W	±	⊤
8				(8	H	X	♣	
9)	9	I	Y	♣	≤
A				*	:	J	Z	⊥	≥
B				+	;	K	[⊤	π
C				,	<	L	\	⊤	≠
D				-	=	M]	⊥	£
E				.	>	N	^	†	•
F				/	?	O		-	

DEC Supplemental

DEC Supplemental									
	GL	0	1	2	3	4	5	6	7
	GR	8	9	A	B	C	D	E	F
0					°	À	¿	à	?
1				ı	±	Á	Ñ	á	ñ
2				¢	²	Â	ò	ã	ó
3				£	³	Ã	ó	ä	ô
4				¤	¸	Ä	ô	å	õ
5				¥	µ	Å	ö	ä	ö
6				¦	¶	Æ	ð	æ	ö
7				§	•	Ç	É	ç	œ
8				¨	¸	È	Ø	è	ø
9				©	ı	É	Ù	é	ù
A				ª	º	Ê	Ú	ê	ú
B				«	»	Ë	Ó	ë	û
C				¸	¼	Ì	Ü	ì	ü
D				¸	½	Í	Ý	í	ý
E				¸	¸	Î	İ	î	ı
F				¸	¸	Ï	ß	ï	ı

DEC Technical

DEC Technical									
	GL	0	1	2	3	4	5	6	7
	GR	8	9	A	B	C	D	E	F
0					†	∴	Π	¬	π
1				↓	∠	α	Ψ	α	ψ
2				∫	∠	∞	∫	β	ρ
3				—	∖	+	Σ	χ	σ
4				∫	/	Δ	∫	δ	τ
5				∫	¬	∇	∫	ε	∫
6				∫	∫	Φ	√	Φ	f
7				∫	>	Γ	Ω	γ	ω
8				∫	∫	~	Ξ	η	ξ
9				∫	∫	≈	Τ	∫	∫
A				∫	∫	⊖	∫	∫	ζ
B				∫	∫	×	∫	κ	←
C				∫	≤	∧	∫	λ	↑
D				∫	≠	∫	∫	∫	→
E				∫	≥	⇒	∧	∫	↓
F				∫	∫	≡	∫	∫	∫

ISO Katakana

ISO Katakana									
	GL	0	1	2	3	4	5	6	7
	GR	8	9	A	B	C	D	E	F
0					ー	夕	ヰ	ㇰ	ㇱ
1				。	ア	チ	ㇲ	ㇰ	ㇱ
2				「	イ	ツ	メ	ㇰ	ㇱ
3				」	ウ	テ	モ	ㇰ	ㇱ
4				、	エ	ト	ヤ	ㇰ	ㇱ
5				・	オ	ナ	ユ	ㇰ	ㇱ
6				ヲ	カ	ニ	ヨ	ㇰ	ㇱ
7				ァ	キ	ヌ	ラ	ㇰ	ㇱ
8				ィ	ク	ネ	リ	ㇰ	ㇱ
9				ゥ	ケ	ノ	ル	ㇰ	ㇱ
A				ェ	コ	ハ	レ	ㇰ	ㇱ
B				ォ	サ	ヒ	ロ	ㇰ	ㇱ
C				ャ	シ	フ	ワ	ㇰ	ㇱ
D				ュ	ス	ヘ	ン	ㇰ	ㇱ
E				ョ	セ	ホ	”	ㇰ	ㇱ
F				ヅ	ソ	マ	。	ㇰ	ㇱ

7-Bit Hebrew

7-Bit Hebrew									
	GL	0	1	2	3	4	5	6	7
	GR	8	9	A	B	C	D	E	F
0					0	@	P	א	ב
1				!	1	A	Q	ב	ד
2			"	2	B	R	א	ב	ד
3			#	3	C	S	ד	ה	ו
4			\$	4	D	T	ה	ו	ז
5			%	5	E	U	ו	ז	ח
6			&	6	F	V	ז	ח	ט
7			'	7	G	W	ח	ט	י
8			(8	H	X	ט	י	כ
9)	9	I	Y	י	כ	ל
A			*	:	J	Z	י	כ	ל
B			+	;	K	[כ	ל	מ
C			,	<	L	\	ל	מ	נ
D			-	=	M]	מ	נ	ס
E			.	>	N	^	נ	ס	ע
F			/	?	O	_	ע	פ	צ

7-Bit Turkish

7-Bit Turkish									
	GL	0	1	2	3	4	5	6	7
	GR	8	9	A	B	C	D	E	F
0					0	ı	P	ğ	p
1				ı	1	A	Q	a	q
2				"	2	B	R	b	r
3				#	3	C	S	c	s
4				\$	4	D	T	d	t
5				%	5	E	U	e	u
6				ğ	6	F	V	f	v
7				'	7	G	W	g	w
8				(8	H	X	h	x
9)	9	I	Y	i	y
A				*	:	J	Z	j	z
B				+	;	K	Ş	k	ş
C				,	<	L	Ü	l	ü
D				-	=	M	Ç	m	ç
E				.	>	N	Ü	n	ü
F				/	?	O	_	o	

Greek Supplemental

Greek Supplemental									
	GL	0	1	2	3	4	5	6	7
	GR	8	9	A	B	C	D	E	F
0					°	ι	ς	ϋ	ς
1				ι	±	Α	Π	α	π
2				ϕ	²	Β	Ρ	β	ρ
3				£	³	Γ	Σ	γ	σ
4				ς	ς	Δ	Τ	δ	τ
5				¥	μ	Ε	Υ	ε	υ
6				ς	¶	Ζ	Φ	ζ	φ
7				§	•	Η	Χ	η	χ
8				¤	ς	Θ	Ψ	θ	ψ
9				€	ι	Ι	Ω	ι	ω
A				≡	Ω	Κ	α	κ	ς
B				«	»	Λ	έ	λ	ύ
C				ς	¼	Μ	ή	μ	ώ
D				ς	½	Ν	ι	ν	΄
E				ς	ς	Ξ	ς	ξ	ς
F				ς	¿	Ο	ο	ο	

Hebrew Supplemental

Hebrew Supplemental									
	GL	0	1	2	3	4	5	6	7
	GR	8	9	A	B	C	D	E	F
0					°	?	?	ח	י
1				i	±	?	?	ב	ב
2				¢	²	?	?	ג	ג
3				£	³	?	?	ד	ד
4				?	?	?	?	ה	ה
5				¥	μ	?	?	ו	ו
6				?	¶	?	?	ז	ז
7				§	•	?	?	ח	ח
8				¤	?	?	?	ט	ט
9				©	ı	?	?	י	י
A						?	?	כ	כ
B				«	»	?	?	ל	?
C				?	¼	?	?	מ	?
D				?	½	?	?	נ	?
E				?	?	?	?	ס	?
F				?	¿	?	?	ע	

Turkish Supplemental

Turkish Supplemental									
	GL	0	1	2	3	4	5	6	7
	GR	8	9	A	B	C	D	E	F
0					°	À	Ǻ	À	Ǻ
1				ı	±	Á	Ñ	á	ñ
2			ϕ	²	À	ò	à	ò	
3			£	³	Ã	ó	ã	ó	
4			¿	¿	Ä	ô	ä	ö	
5			¥	µ	Å	õ	å	õ	
6			¿	¶	Æ	ü	æ	ö	
7			§	•	Ç	œ	ç	œ	
8			¤	¿	È	ø	è	ø	
9			€	ı	É	ú	é	ú	
A			à	ó	Ê	û	ê	û	
B			«	»	Ë	ü	ë	ü	
C			¿	¼	İ	Û	ı	Û	
D			¿	½	ı	Ý	ı	ÿ	
E			ı	ı	İ	Ş	ı	ş	
F			¿	¿	İ	ß	ı		

LG Emulation 96-Character Sets

The following pages show the 96-Character Set charts (also referred to as code pages) for the LG emulation. The character sets are shown in Near Letter Quality (NLQ) print mode. These character sets may be selected using the configuration menus, described in the *Setup Guide*.

ISO Latin 1									
	GL	0	1	2	3	4	5	6	7
	GR	8	9	A	B	C	D	E	F
0					°	À	Ð	à	ð
1				í	±	Á	Ñ	á	ñ
2				¢	²	Â	ò	â	ó
3				£	³	Ã	ó	ã	ô
4				¤	´	Ä	ô	ä	õ
5				¥	µ	Å	ö	å	ø
6				¦	¶	Æ	ù	æ	ö
7				§	•	Ç	×	ç	÷
8				¨	,	È	Ø	è	ø
9				©	¡	É	Ù	é	ù
A				ª	º	Ê	Ú	ê	ú
B				«	»	Ë	Û	ë	û
C				¬	¼	Ì	Ü	ì	ü
D				–	½	Í	Ý	í	ý
E				®	¾	Î	Þ	î	þ
F				—	¿	Ï	ß	ï	ÿ

ISO Latin 2

ISO Latin 2									
	GL	0	1	2	3	4	5	6	7
	GR	8	9	A	B	C	D	E	F
0					°	Ř	Đ	ř	đ
1				Ą	ą	Á	Ñ	á	ñ
2				˘	˙	À	Ń	à	ń
3				Ł	ł	Å	Ó	å	ó
4				Ø	’	Ä	Ô	ä	ô
5				Ł	Ÿ	Ł	Ø	ı	ö
6				Ś	ś	Ć	Ď	ć	ď
7				Ş	˘	Ç	×	ş	+
8				“	”	Č	Ř	č	ř
9				Š	š	Ě	Ů	ě	ů
A				Ş	ş	Ě	Ů	ş	ů
B				Ŧ	ŧ	Ě	Ů	ě	ů
C				Ž	ž	Ě	Ů	ě	ů
D				–	”	ı	Ÿ	ı	ÿ
E				Ž	ž	ı	Ÿ	ı	ÿ
F				ž	z	Đ	β	đ	·

ISO Latin 5

ISO Latin 5									
	GL	0	1	2	3	4	5	6	7
	GR	8	9	A	B	C	D	E	F
0					°	À	Á	Â	Ë
1				Ì	Í	Ā	Ñ	ã	ñ
2			Φ	²	Â	ò	ã	ò	
3			£	³	Ã	ó	ä	ó	
4			¤	'	Ä	ô	ä	ô	
5			¥	µ	Å	õ	å	õ	
6			¦	¶	Æ	ö	æ	ö	
7			§	•	Ç	×	ç	÷	
8			"	,	È	Ø	è	ø	
9			©	ı	É	Ú	é	ù	
A			â	ó	Ê	Û	ê	ú	
B			«	»	Ë	Ô	ë	û	
C			¬	¼	Ī	Ü	ı	ü	
D			–	½	İ	ı	ı	ı	
E			®	¾	İ	Ş	î	ş	
F			–	¿	İ	ß	ï	ÿ	

ISO Latin 9

ISO Latin 9									
	GL	0	1	2	3	4	5	6	7
	GR	8	9	A	B	C	D	E	F
0					°	À	Ð	à	ð
1				ı	±	Á	Ñ	á	ñ
2				¢	²	Â	Ò	â	ò
3				£	³	Ã	Ó	ã	ó
4				€	ˆ	Ä	Ô	ä	ô
5				¥	µ	Å	Õ	å	õ
6				§	¶	Æ	Ü	æ	ü
7				§	•	Ç	×	ç	+
8				§	ˆ	È	Ø	è	ø
9				©	ı	É	Ú	é	ú
A				®	®	Ê	Û	ê	û
B				«	»	Ë	Ü	ë	ü
C				¬	®	İ	ı	ı	ı
D				–	®	ı	Y	ı	y
E				®	Y	ı	Þ	ı	þ
F				–	ı	ı	ß	ı	ÿ

ISO Cyrillic

ISO Cyrillic									
	GL	0	1	2	3	4	5	6	7
	GR	8	9	A	B	C	D	E	F
0					А	Р	а	р	№
1				Ё	Б	С	б	с	ё
2				Ѡ	В	Т	в	т	ѡ
3				Ґ	Г	У	г	у	ѓ
4				Є	Д	Ф	д	ф	є
5				Ѕ	Е	Х	е	х	ѕ
6				І	Ж	Ц	ж	ц	і
7				Ї	Э	Ч	э	ч	ї
8				Ј	И	Ш	и	ш	ј
9				Љ	И	Щ	й	щ	љ
A				Њ	К	Ъ	к	ъ	њ
B				Ѣ	Л	Ы	л	ы	ѣ
C				К	М	Ь	м	ь	к
D				–	Н	Э	н	э	ѝ
E				Ў	О	Ю	о	ю	ў
F				Ў	П	Я	п	я	џ

ISO Greek

ISO Greek									
	GL	0	1	2	3	4	5	6	7
	GR	8	9	A	B	C	D	E	F
0					°	ı	Π	Û	π
1				´	±	Α	Ρ	α	ρ
2				˘	²	Β	ς	β	ς
3				£	³	Γ	Σ	γ	σ
4				ς	´	Δ	Τ	δ	τ
5				ς	˙	Ε	Υ	ε	υ
6				ı	Α	Ζ	Φ	ζ	φ
7				ς	•	Η	Χ	η	χ
8				"	Ε	Θ	Ψ	θ	ψ
9				⊙	Η	Ι	Ω	ι	ω
A				ς	Ι	Κ	ı	κ	ı
B				«	»	Λ	Υ	λ	υ
C				¬	Ό	Μ	α	μ	ό
D				—	½	Ν	έ	ν	ύ
E				ς	Υ	Ξ	ή	ξ	ώ
F				—	Ω	Ο	ι	ο	ς

ISO Hebrew

ISO Hebrew									
	GL	0	1	2	3	4	5	6	7
	GR	8	9	A	B	C	D	E	F
0					°	@	P	κ	ן
1				?	±	A	Q	י	ו
2				φ	²	B	R	λ	מ
3				£	³	C	S	τ	ף
4				¤	'	D	T	η	צ
5				¥	μ	E	U	ι	ץ
6				¦	¶	F	V	ς	ץ
7				§	•	G	W	π	ק
8				"	,	H	X	σ	ך
9				©	ı	I	Y	ι	ש
A				×	÷	J	Z	γ	ת
B				«	»	K	[κ	ף
C				¬	¼	L	\	λ	ף
D				-	½	M]	μ	ף
E				®	¾	N	^	ν	ף
F				-	?	O	=	ξ	ף

B *Interface Configuration with the VMS Operating System*

Parallel Interface

When using the parallel interface with the VMS operating system, configure the printer with the SET PRINTER command, as shown below:

Printer LCA0:, device type unknown, is on-line, allocated record-oriented device, carriage control, device is spooled through an intermediate device, error logging is enabled.

Error count	0
Owner process	"SYMBIONT_0001"
Owner process ID	00000087
Reference Count	2
Page width	132
Carriage return	Formfeed
No passall	No Wrap
No Fallback	Tab
Intermediate device:	DUA1
Associated queue:	LCA0
Operations completed	1
Owner UIC	[0, 0]
Dev Prot	S:RWLP, 0:RWLP, W:RWLP
Default buffer size	132
Page length	66
Lowercase Printall	
No Truncate	

Serial Interface

When using the serial interface with the VMS operating system, configure the terminal characteristics with the SET TERM command, as shown below:

Terminal: _TXA3: Device_Type: Unknown Owner: SYMBIONT_0001
Username: SYSTEM

Input: 9600* LFill: 0 Width: 132 Parity: None

Output: 9600* CRfill: 0 Page: 66

Terminal Characteristics:

Interactive	Echo	Type_ahead	No_Escape
No_Hostsync	TTsync	Lowercase	Tab
No_Wrap	Scope	No_Remote	No_Eightbit
No_Broadcast	No_Readsync	Form	Fulldup
No_Modem	No_Local_echo	No_Autobaud	No_Hangup
No_Brdcstambx	No_DMA	No_Altypeahd	Set_speed
Line_Editing	Overstrike_editing	No_Fallback	No_Dialup
No_Secure_server	No_Disconnect	No_Pasthru	No_Syspassword
No_SIXEL_Graphics	No_Soft_Characters	No_Printer_Port	Numeric_Keypad
No_ANSI_CRT	No_Regis	No_Block_mode	No_Advanced_video
No_Edit_mode	No_DEC_CRT	No_DEC_CRT	

Device spooled to _DUAL:

* Match baud rate to printer settings.

C *Type Family IDs, Font IDs, Font File IDs*

“Built-In” Font File IDs

This appendix explains the values used in the font file identification strings (IDs) for the font files stored in the printer. It also lists all the font file IDs available in LG emulation mode.

The Font File ID Field Definitions table on page 212 lists and defines all the values in a font file ID. The values are based on 36 possible values (0-9, A-Z). The table shows the relationship between type family IDs, font IDs, and font file IDs.

Notice, for example, that the 31-character **font file ID** also contains the type family ID and font ID. The **type family ID** is field 1 (the first 7 characters) of the 31-character font file ID. The **font ID** consists of fields 1 through 7 (the first 16 characters) of the 31-character font file ID.

Font File ID Field Definitions

	Field	Bytes	Field Name	Value	Meaning
Font ID	1	1 to 7	Type family ID	R	Registered internationally or in the public domain
				D	DIGITAL reserved
	2	8	Spacing	E	5 pitch
				I	6 pitch
				G	7 pitch
				W	8.33 pitch
				J	10 pitch
				2	10.3 pitch
				L	12 pitch
				4	13.3 pitch
				1	13.6 pitch
				O	15 pitch
	3	9 to 11	Type Size	5	16.7 pitch
				02S	10 point
				03C	12 point
				050	18 point
				4	12
	5	13 to 14	Style	00	Normal
				01	Italic
	6	15	Weight	G	Regular
	7	16	Proportion	G	Regular
	8	17 to 18	Rotation	00	No rotation
	9	19 to 21	Character Set	01C	VT100
				01O	DEC Supplemental
				01Q	DEC Technical
				01U	U.S. ASCII
				GDE	ISO Latin 2
				GDI	ISO Greek
				GDK	ISO Hebrew
				GDO	ISO Cyrillic
				GDP	ISO Latin 5
24D				7-Bit Hebrew	
242				7-Bit Turkish	
1TR				Greek Supplemental	
1TG				Hebrew Supplemental	
240	Turkish Supplemental				
10	22 to 25	Character	ZZZZ	Full character set subset	
11	26 to 27	File encoding	02	Binary (See NOTE below.)	
			B	100 dots per inch	
12	28	Resolution	D	200 dots per inch	
			Z	Other	
13	29	Reserved	0	Reserved	
14	30	Reserved	0	Reserved	
15	31	Reserved	0	Reserved	

NOTE: This field is used only for the file name and not to distinguish between a sixel file and a binary file.

Type Family IDs

The type families available in LG emulation mode have the following names and identification strings:

Type Family Name	Identification String (ID)
Compressed Print	DCMPRSS
Correspondence Plot	DCRRSPL
Correspondence Print	DCRRSPN
Data Processing	DBULTN1
Draft Plot	DDRAFT0
High Speed Draft Print	DDRAFT1
LG Near Letter Quality	DLGNRLQ
Low Density Plot	DLODENS
OCR A	ROCRA00
OCR B	ROCRB00

The D in the ID string for DCRRSPN means the name Correspondence Print is registered with Compaq, but is not registered internationally. The R in the ID strings for OCR A and OCR B means these names are registered internationally or are in the public domain.

Font File IDs

This section lists all type family names, type family IDs, font IDs, and font file IDs available in LG emulation mode.

The 31-character **font file ID** also contains the type family ID and font ID. The **type family ID** is the first 7 characters of the font file ID. The **font ID** is the first 16 characters of the 31-character font file ID.

Pitch	Type Size	Character Set	Font File ID (entire string) Font ID (First 16 characters)
1.		Type Family Name: DEC Built-in 1 (Data Processing)	Type Family ID: DBULTN1
5	12	U.S. ASCII	DBULTN1 E 03C K 00GG 00 01U ZZZZ 02Z000
5	12	DEC Supp.	DBULTN1 E 03C K 00GG 00 01O ZZZZ 02Z000
5	12	DEC Tech.	DBULTN1 E 03C K 00GG 00 01Q ZZZZ 02Z000
5	12	ISO Latin 2	DBULTN1 E 03C K 00GG 00 GDE ZZZZ 02Z000
5	12	ISO Cyrillic	DBULTN1 E 03C K 00GG 00 GDO ZZZZ 02Z000
5	12	ISO Greek	DBULTN1 E 03C K 00GG 00 GDI ZZZZ 02Z000
5	12	ISO Hebrew	DBULTN1 E 03C K 00GG 00 GDK ZZZZ 02Z000
5	12	ISO Latin 5	DBULTN1 E 03C K 00GG 00 GDP ZZZZ 02Z000
5	12	VT 100	DBULTN1 E 03C K 00GG 00 01C ZZZZ 02Z000
5	12	7-Bit Hebrew	DBULTN1 E 03C K 00GG 00 24D ZZZZ 02Z000
5	12	7-Bit Turkish	DBULTN1 E 03C K 00GG 00 242 ZZZZ 02Z000
5	12	Greek Suppl.	DBULTN1 E 03C K 00GG 00 1TR ZZZZ 02Z000
5	12	Hebrew Suppl.	DBULTN1 E 03C K 00GG 00 1TG ZZZZ 02Z000
5	12	Turkish Suppl.	DBULTN1 E 03C K 00GG 00 240 ZZZZ 02Z000
6	12	U.S. ASCII	DBULTN1 I 03C K 00GG 00 01U ZZZZ 02Z000
6	12	DEC Supp.	DBULTN1 I 03C K 00GG 00 01O ZZZZ 02Z000
6	12	DEC Tech.	DBULTN1 I 03C K 00GG 00 01Q ZZZZ 02Z000
6	12	ISO Latin 2	DBULTN1 I 03C K 00GG 00 GDE ZZZZ 02Z000
6	12	ISO Cyrillic	DBULTN1 I 03C K 00GG 00 GDO ZZZZ 02Z000
6	12	ISO Greek	DBULTN1 I 03C K 00GG 00 GDI ZZZZ 02Z000
6	12	ISO Hebrew	DBULTN1 I 03C K 00GG 00 GDK ZZZZ 02Z000
6	12	ISO Latin 5	DBULTN1 I 03C K 00GG 00 GDP ZZZZ 02Z000
6	12	VT 100	DBULTN1 I 03C K 00GG 00 01C ZZZZ 02Z000
6	12	7-Bit Hebrew	DBULTN1 E 03C K 00GG 00 24D ZZZZ 02Z000
6	12	7-Bit Turkish	DBULTN1 E 03C K 00GG 00 242 ZZZZ 02Z000
6	12	Greek Suppl.	DBULTN1 E 03C K 00GG 00 1TR ZZZZ 02Z000
6	12	Hebrew Suppl.	DBULTN1 E 03C K 00GG 00 1TG ZZZZ 02Z000
6	12	Turkish Suppl.	DBULTN1 E 03C K 00GG 00 240 ZZZZ 02Z000
10	12	U.S. ASCII	DBULTN1 J 03C K 00GG 00 01U ZZZZ 02Z000
10	12	DEC Supp.	DBULTN1 J 03C K 00GG 00 01O ZZZZ 02Z000
10	12	DEC Tech.	DBULTN1 J 03C K 00GG 00 01Q ZZZZ 02Z000
10	12	ISO Latin 2	DBULTN1 J 03C K 00GG 00 GDE ZZZZ 02Z000
10	12	ISO Cyrillic	DBULTN1 J 03C K 00GG 00 GDO ZZZZ 02Z000
10	12	ISO Greek	DBULTN1 J 03C K 00GG 00 GDI ZZZZ 02Z000
10	12	ISO Hebrew	DBULTN1 J 03C K 00GG 00 GDK ZZZZ 02Z000
10	12	ISO Latin 5	DBULTN1 J 03C K 00GG 00 GDP ZZZZ 02Z000
10	12	VT 100	DBULTN1 J 03C K 00GG 00 01C ZZZZ 02Z000
10	12	7-Bit Hebrew	DBULTN1 E 03C K 00GG 00 24D ZZZZ 02Z000
10	12	7-Bit Turkish	DBULTN1 E 03C K 00GG 00 242 ZZZZ 02Z000
10	12	Greek Suppl.	DBULTN1 E 03C K 00GG 00 1TR ZZZZ 02Z000
10	12	Hebrew Suppl.	DBULTN1 E 03C K 00GG 00 1TG ZZZZ 02Z000
10	12	Turkish Suppl.	DBULTN1 E 03C K 00GG 00 240 ZZZZ 02Z000

continued on next page

NOTE: The font file IDs are spaced for clarity. The spaces are not part of the actual ID string

Pitch	Type Size	Character Set	Font File ID (entire string) Font ID (First 16 characters)
DEC Built-in 1 continued			Type Family ID: DBULTN1
(Data Processing)			
12	12	U.S. ASCII	DBULTN1 L 03C K 00GG 00 01U ZZZZ 02Z000
12	12	DEC Supp.	DBULTN1 L 03C K 00GG 00 01O ZZZZ 02Z000
12	12	DEC Tech.	DBULTN1 L 03C K 00GG 00 01Q ZZZZ 02Z000
12	12	ISO Latin 2	DBULTN1 L 03C K 00GG 00 GDE ZZZZ 02Z000
12	12	ISO Cyrillic	DBULTN1 L 03C K 00GG 00 GDO ZZZZ 02Z000
12	12	ISO Greek	DBULTN1 L 03C K 00GG 00 GDI ZZZZ 02Z000
12	12	ISO Hebrew	DBULTN1 L 03C K 00GG 00 GDK ZZZZ 02Z000
12	12	ISO Latin 5	DBULTN1 L 03C K 00GG 00 GDP ZZZZ 02Z000
12	12	VT 100	DBULTN1 L 03C K 00GG 00 01C ZZZZ 02Z000
12	12	7-Bit Hebrew	DBULTN1 E 03C K 00GG 00 24D ZZZZ 02Z000
12	12	7-Bit Turkish	DBULTN1 E 03C K 00GG 00 242 ZZZZ 02Z000
12	12	Greek Suppl.	DBULTN1 E 03C K 00GG 00 1TR ZZZZ 02Z000
12	12	Hebrew Suppl.	DBULTN1 E 03C K 00GG 00 1TG ZZZZ 02Z000
12	12	Turkish Suppl.	DBULTN1 E 03C K 00GG 00 240 ZZZZ 02Z000
15	10	U.S. ASCII	DBULTN1 O 02S K 00GG 00 01U ZZZZ 02Z000
15	10	DEC Supp.	DBULTN1 O 02S K 00GG 00 01O ZZZZ 02Z000
15	10	DEC Tech.	DBULTN1 O 02S K 00GG 00 01Q ZZZZ 02Z000
15	10	ISO Latin 2	DBULTN1 O 02S K 00GG 00 GDE ZZZZ 02Z000
15	10	ISO Cyrillic	DBULTN1 O 02S K 00GG 00 GDO ZZZZ 02Z000
15	10	ISO Greek	DBULTN1 O 02S K 00GG 00 GDI ZZZZ 02Z000
15	10	ISO Hebrew	DBULTN1 O 02S K 00GG 00 GDK ZZZZ 02Z000
15	10	ISO Latin 5	DBULTN1 O 02S K 00GG 00 GDP ZZZZ 02Z000
15	10	VT 100	DBULTN1 O 02S K 00GG 00 01C ZZZZ 02Z000
15	10	7-Bit Hebrew	DBULTN1 E 03C K 00GG 00 24D ZZZZ 02Z000
15	10	7-Bit Turkish	DBULTN1 E 03C K 00GG 00 242 ZZZZ 02Z000
15	10	Greek Suppl.	DBULTN1 E 03C K 00GG 00 1TR ZZZZ 02Z000
15	10	Hebrew Suppl.	DBULTN1 E 03C K 00GG 00 1TG ZZZZ 02Z000
15	10	Turkish Suppl.	DBULTN1 E 03C K 00GG 00 240 ZZZZ 02Z000

NOTE: The font file IDs are spaced for clarity. The spaces are not part of the actual ID string

Pitch	Type Size	Character Set	Font File ID (entire string) Font ID (First 16 characters)
2.		Type Family Name: Correspondence Print	Type Family ID: DCRRSPN
5	10	U.S. ASCII	DCRRSPN E 02S K 00GG 00 01U ZZZZ 02Z000
5	10	DEC Supp.	DCRRSPN E 02S K 00GG 00 01O ZZZZ 02Z000
5	10	DEC Tech.	DCRRSPN E 02S K 00GG 00 01Q ZZZZ 02Z000
5	10	ISO Latin 2	DCRRSPN E 02S K 00GG 00 GDE ZZZZ 02Z000
5	10	ISO Cyrillic	DCRRSPN E 02S K 00GG 00 GDO ZZZZ 02Z000
5	10	ISO Greek	DCRRSPN E 02S K 00GG 00 GDI ZZZZ 02Z000
5	10	ISO Hebrew	DCRRSPN E 02S K 00GG 00 GDK ZZZZ 02Z000
5	10	ISO Latin 5	DCRRSPN E 02S K 00GG 00 GDP ZZZZ 02Z000
5	10	VT 100	DCRRSPN E 02S K 00GG 00 01C ZZZZ 02Z000
5	10	7-Bit Hebrew	DCRRSPN E 02S K 00GG 00 24D ZZZZ 02Z000
5	10	7-Bit Turkish	DCRRSPN E 02S K 00GG 00 242 ZZZZ 02Z000
5	10	Greek Suppl.	DCRRSPN E 02S K 00GG 00 1TR ZZZZ 02Z000
5	10	Hebrew Suppl.	DCRRSPN E 02S K 00GG 00 1TG ZZZZ 02Z000
5	10	Turkish Suppl.	DCRRSPN E 02S K 00GG 00 240 ZZZZ 02Z000
6	10	U.S. ASCII	DCRRSPN I 02S K 00GG 00 01U ZZZZ 02Z000
6	10	DEC Supp.	DCRRSPN I 02S K 00GG 00 01O ZZZZ 02Z000
6	10	DEC Tech.	DCRRSPN I 02S K 00GG 00 01Q ZZZZ 02Z000
6	10	ISO Latin 2	DCRRSPN I 02S K 00GG 00 GDE ZZZZ 02Z000
6	10	ISO Cyrillic	DCRRSPN I 02S K 00GG 00 GDO ZZZZ 02Z000
6	10	ISO Greek	DCRRSPN I 02S K 00GG 00 GDI ZZZZ 02Z000
6	10	ISO Hebrew	DCRRSPN I 02S K 00GG 00 GDK ZZZZ 02Z000
6	10	ISO Latin 5	DCRRSPN I 02S K 00GG 00 GDP ZZZZ 02Z000
6	10	VT 100	DCRRSPN I 02S K 00GG 00 01C ZZZZ 02Z000
6	10	7-Bit Hebrew	DCRRSPN E 02S K 00GG 00 24D ZZZZ 02Z000
6	10	7-Bit Turkish	DCRRSPN E 02S K 00GG 00 242 ZZZZ 02Z000
6	10	Greek Suppl.	DCRRSPN E 02S K 00GG 00 1TR ZZZZ 02Z000
6	10	Hebrew Suppl.	DCRRSPN E 02S K 00GG 00 1TG ZZZZ 02Z000
6	10	Turkish Suppl.	DCRRSPN E 02S K 00GG 00 240 ZZZZ 02Z000
10	10	U.S. ASCII	DCRRSPN J 02S K 00GG 00 01U ZZZZ 02Z000
10	10	DEC Supp.	DCRRSPN J 02S K 00GG 00 01O ZZZZ 02Z000
10	10	DEC Tech.	DCRRSPN J 02S K 00GG 00 01Q ZZZZ 02Z000
10	10	ISO Latin 2	DCRRSPN J 02S K 00GG 00 GDE ZZZZ 02Z000
10	10	ISO Cyrillic	DCRRSPN J 02S K 00GG 00 GDO ZZZZ 02Z000
10	10	ISO Greek	DCRRSPN J 02S K 00GG 00 GDI ZZZZ 02Z000
10	10	ISO Hebrew	DCRRSPN J 02S K 00GG 00 GDK ZZZZ 02Z000
10	10	ISO Latin 5	DCRRSPN J 02S K 00GG 00 GDP ZZZZ 02Z000
10	10	VT 100	DCRRSPN J 02S K 00GG 00 01C ZZZZ 02Z000
10	10	7-Bit Hebrew	DCRRSPN E 02S K 00GG 00 24D ZZZZ 02Z000
10	10	7-Bit Turkish	DCRRSPN E 02S K 00GG 00 242 ZZZZ 02Z000
10	10	Greek Suppl.	DCRRSPN E 02S K 00GG 00 1TR ZZZZ 02Z000
10	10	Hebrew Suppl.	DCRRSPN E 02S K 00GG 00 1TG ZZZZ 02Z000
10	10	Turkish Suppl.	DCRRSPN E 02S K 00GG 00 240 ZZZZ 02Z000

continued on next page

NOTE: The font file IDs are spaced for clarity. The spaces are not part of the actual ID string

Pitch	Type Size	Character Set	Font File ID (entire string) Font ID (First 16 characters)
Correspondence Print continued			Type Family ID: DCRRSPN
12	10	U.S. ASCII	DCRRSPN L 02S K 00GG 00 01U ZZZZ 02Z000
12	10	DEC Supp.	DCRRSPN L 02S K 00GG 00 01O ZZZZ 02Z000
12	10	DEC Tech.	DCRRSPN L 02S K 00GG 00 01Q ZZZZ 02Z000
12	10	ISO Latin 2	DCRRSPN L 02S K 00GG 00 GDE ZZZZ 02Z000
12	10	ISO Cyrillic	DCRRSPN L 02S K 00GG 00 GDO ZZZZ 02Z000
12	10	ISO Greek	DCRRSPN L 02S K 00GG 00 GDI ZZZZ 02Z000
12	10	ISO Hebrew	DCRRSPN L 02S K 00GG 00 GDK ZZZZ 02Z000
12	10	ISO Latin 5	DCRRSPN L 02S K 00GG 00 GDP ZZZZ 02Z000
12	10	VT 100	DCRRSPN L 02S K 00GG 00 01C ZZZZ 02Z000
12	10	7-Bit Hebrew	DCRRSPN E 02S K 00GG 00 24D ZZZZ 02Z000
12	10	7-Bit Turkish	DCRRSPN E 02S K 00GG 00 242 ZZZZ 02Z000
12	10	Greek Suppl.	DCRRSPN E 02S K 00GG 00 1TR ZZZZ 02Z000
12	10	Hebrew Suppl.	DCRRSPN E 02S K 00GG 00 1TG ZZZZ 02Z000
12	10	Turkish Suppl.	DCRRSPN E 02S K 00GG 00 240 ZZZZ 02Z000
15	10	U.S. ASCII	DCRRSPN O 02S K 00GG 00 01U ZZZZ 02Z000
15	10	DEC Supp.	DCRRSPN O 02S K 00GG 00 01O ZZZZ 02Z000
15	10	DEC Tech.	DCRRSPN O 02S K 00GG 00 01Q ZZZZ 02Z000
15	10	ISO Latin 2	DCRRSPN O 02S K 00GG 00 GDE ZZZZ 02Z000
15	10	ISO Cyrillic	DCRRSPN O 02S K 00GG 00 GDO ZZZZ 02Z000
15	10	ISO Greek	DCRRSPN O 02S K 00GG 00 GDI ZZZZ 02Z000
15	10	ISO Hebrew	DCRRSPN O 02S K 00GG 00 GDK ZZZZ 02Z000
15	10	ISO Latin 5	DCRRSPN O 02S K 00GG 00 GDP ZZZZ 02Z000
15	10	VT 100	DCRRSPN O 02S K 00GG 00 01C ZZZZ 02Z000
15	10	7-Bit Hebrew	DCRRSPN E 02S K 00GG 00 24D ZZZZ 02Z000
15	10	7-Bit Turkish	DCRRSPN E 02S K 00GG 00 242 ZZZZ 02Z000
15	10	Greek Suppl.	DCRRSPN E 02S K 00GG 00 1TR ZZZZ 02Z000
15	10	Hebrew Suppl.	DCRRSPN E 02S K 00GG 00 1TG ZZZZ 02Z000
15	10	Turkish Suppl.	DCRRSPN E 02S K 00GG 00 240 ZZZZ 02Z000

NOTE: The font file IDs are spaced for clarity. The spaces are not part of the actual ID string

Pitch	Type Size	Character Set	Font File ID (entire string) Font ID (First 16 characters)
3.		Type Family Name: OCR A	Type Family ID: ROCRA00
10	10	U.S. ASCII	ROCRA00 J 02S K 00GG 00 01U ZZZZ 02Z000
4.		Type Family Name: OCR B	Type Family ID: ROCRB00
10	10	U.S. ASCII	ROCRB00 J 02S K 00GG 00 01U ZZZZ 02Z000
5.		Type Family Name: Compressed Print	Type Family ID: DCMPRSS
6.67	10	U.S. ASCII	DCMPRSS I 02S K 00GG 00 01U ZZZZ 02Z000
6.67	10	DEC Supp.	DCMPRSS I 02S K 00GG 00 01O ZZZZ 02Z000
6.67	10	Dec Tedh.	DCMPRSS I 02S K 00GG 00 01Q ZZZZ 02Z000
6.67	10	ISO Latin 2	DCMPRSS I 02S K 00GG 00 GDE ZZZZ 02Z000
6.67	10	ISO Cyrillic	DCMPRSS I 02S K 00GG 00 GDO ZZZZ 02Z000
6.67	10	ISO Greek	DCMPRSS I 02S K 00GG 00 GDI ZZZZ 02Z000
6.67	10	ISO Hebrew	DCMPRSS I 02S K 00GG 00 GDK ZZZZ 02Z000
6.67	10	ISO Latin 5	DCMPRSS I 02S K 00GG 00 GDP ZZZZ 02Z000
6.67	10	VT 100	DCMPRSS 4 02S K 00GG 00 01C ZZZZ 02Z000
6.67	10	7-Bit Hebrew	DCMPRSS I 02S K 00GG 00 24D ZZZZ 02Z000
6.67	10	7-Bit Turkish	DCMPRSS I 02S K 00GG 00 242 ZZZZ 02Z000
6.67	10	Greek Suppl.	DCMPRSS I 02S K 00GG 00 1TR ZZZZ 02Z000
6.67	10	Hebrew Suppl.	DCMPRSS I 02S K 00GG 00 1TG ZZZZ 02Z000
6.67	10	Turkish Suppl.	DCMPRSS 4 02S K 00GG 00 240 ZZZZ 02Z000
8.33	10	U.S. ASCII	DCMPRSS W 02S K 00GG 00 01U ZZZZ 02Z000
8.33	10	DEC Supp.	DCMPRSS W 02S K 00GG 00 01O ZZZZ 02Z000
8.33	10	DEC Tech.	DCMPRSS W 02S K 00GG 00 01Q ZZZZ 02Z000
8.33	10	ISO Latin 2	DCMPRSS W 02S K 00GG 00 GDE ZZZZ 02Z000
8.33	10	ISO Cyrillic	DCMPRSS W 02S K 00GG 00 GDO ZZZZ 02Z000
8.33	10	ISO Greek	DCMPRSS W 02S K 00GG 00 GDI ZZZZ 02Z000
8.33	10	ISO Hebrew	DCMPRSS W 02S K 00GG 00 GDK ZZZZ 02Z000
8.33	10	ISO Latin 5	DCMPRSS W 02S K 00GG 00 GDP ZZZZ 02Z000
8.33	10	VT 100	DCMPRSS 4 02S K 00GG 00 01C ZZZZ 02Z000
8.33	10	7-Bit Hebrew	DCMPRSS I 02S K 00GG 00 24D ZZZZ 02Z000
8.33	10	7-Bit Turkish	DCMPRSS I 02S K 00GG 00 242 ZZZZ 02Z000
8.33	10	Greek Suppl.	DCMPRSS I 02S K 00GG 00 1TR ZZZZ 02Z000
8.33	10	Hebrew Suppl.	DCMPRSS I 02S K 00GG 00 1TG ZZZZ 02Z000
8.33	10	Turkish Suppl.	DCMPRSS 4 02S K 00GG 00 240 ZZZZ 02Z000

continued on next page

NOTE: The font file IDs are spaced for clarity. The spaces are not part of the actual ID string

Pitch	Type Size	Character Set	Font File ID (entire string) Font ID (First 16 characters)
Compressed Print continued			Type Family ID: DCMPRSS
13.3	10	U.S. ASCII	DCMPRSS 4 02S K 00GG 00 01U ZZZZ 02Z000
13.3	10	DEC Supp.	DCMPRSS 4 02S K 00GG 00 01O ZZZZ 02Z000
13.3	10	DEC Tech.	DCMPRSS 4 02S K 00GG 00 01Q ZZZZ 02Z000
13.3	10	ISO Latin 2	DCMPRSS 4 02S K 00GG 00 GDE ZZZZ 02Z000
13.3	10	ISO Cyrillic	DCMPRSS 4 02S K 00GG 00 GDO ZZZZ 02Z000
13.3	10	ISO Greek	DCMPRSS 4 02S K 00GG 00 GDI ZZZZ 02Z000
13.3	10	ISO Hebrew	DCMPRSS 4 02S K 00GG 00 GDK ZZZZ 02Z000
13.3	10	ISO Latin 5	DCMPRSS 4 02S K 00GG 00 GDP ZZZZ 02Z000
13.3	10	VT 100	DCMPRSS 4 02S K 00GG 00 01C ZZZZ 02Z000
13.3	10	7-Bit Hebrew	DCMPRSS I 02S K 00GG 00 24D ZZZZ 02Z000
13.3	10	7-Bit Turkish	DCMPRSS I 02S K 00GG 00 242 ZZZZ 02Z000
13.3	10	Greek Suppl.	DCMPRSS I 02S K 00GG 00 1TR ZZZZ 02Z000
13.3	10	Hebrew Suppl.	DCMPRSS I 02S K 00GG 00 1TG ZZZZ 02Z000
13.3	10	Turkish Suppl.	DCMPRSS 4 02S K 00GG 00 240 ZZZZ 02Z000
16.7	10	U.S. ASCII	DCMPRSS 5 02S K 00GG 00 01U ZZZZ 02Z000
16.7	10	DEC Supp.	DCMPRSS 5 02S K 00GG 00 01O ZZZZ 02Z000
16.7	10	DEC Tech.	DCMPRSS 5 02S K 00GG 00 01Q ZZZZ 02Z000
16.7	10	ISO Latin 2	DCMPRSS 5 02S K 00GG 00 GDE ZZZZ 02Z000
16.7	10	ISO Cyrillic	DCMPRSS 5 02S K 00GG 00 GDO ZZZZ 02Z000
16.7	10	ISO Greek	DCMPRSS 5 02S K 00GG 00 GDI ZZZZ 02Z000
16.7	10	ISO Hebrew	DCMPRSS 5 02S K 00GG 00 GDK ZZZZ 02Z000
16.7	10	ISO Latin 5	DCMPRSS 5 02S K 00GG 00 GDP ZZZZ 02Z000
16.7	10	VT 100	DCMPRSS 5 02S K 00GG 00 01C ZZZZ 02Z000
16.7	10	7-Bit Hebrew	DCMPRSS I 02S K 00GG 00 24D ZZZZ 02Z000
16.7	10	7-Bit Turkish	DCMPRSS I 02S K 00GG 00 242 ZZZZ 02Z000
16.7	10	Greek Suppl.	DCMPRSS I 02S K 00GG 00 1TR ZZZZ 02Z000
16.7	10	Hebrew Suppl.	DCMPRSS I 02S K 00GG 00 1TG ZZZZ 02Z000
16.7	10	Turkish Suppl.	DCMPRSS 4 02S K 00GG 00 240 ZZZZ 02Z000
6.	Type Family Name: High Speed Draft Print		Type Family ID: DDRAFT1
10	12	U.S. ASCII	DDRAFT1 J 03C K 00GG 00 01U ZZZZ 02Z000
10	12	DEC Supp.	DDRAFT1 J 03C K 00GG 00 01O ZZZZ 02Z000

NOTE: The font file IDs are spaced for clarity. The spaces are not part of the actual ID string

Pitch	Type Size	Character Set	Font File ID (entire string) Font ID (First 16 characters)
7.		Type Family Name: LG Near Letter Quality	Type Family ID: DLGNRLQ
7	18	U.S. ASCII	DLGNRLQ G 050 K 00 G G 00 01U ZZZZ 02 D000
7	18	DEC Supp.	DLGNRLQ G 050 K 00 G G 00 01O ZZZZ 02 D000
7	18	VT100	DLGNRLQ G 050 K 00 G G 00 01C ZZZZ 02 D000
7	18	ISO Latin 1	DLGNRLQ G 050 K 00 G G 00 6DD ZZZZ 02 D000
10	12	U.S. ASCII	DLGNRLQ J 03C K 00 G G 00 01U ZZZZ 02 D000
10	12	DEC Supp.	DLGNRLQ J 03C K 00 G G 00 01O ZZZZ 02 D000
10	12	DEC Tech.	DLGNRLQ J 03C K 00 G G 00 01Q ZZZZ 02 D000
10	12	VT100	DLGNRLQ J 03C K 00 G G 00 01C ZZZZ 02 D000
10	12	ISO Latin 1	DLGNRLQ J 03C K 00 G G 00 6DD ZZZZ 02 D000
10	12	VT100 Italic	DLGNRLQ J 03C K 00 G G 01 01C ZZZZ 02 D000
10	12	ASCII Italic	DLGNRLQ J 03C K 00 G G 01 01U ZZZZ 02 D000
10	12	DEC Supp. Italic	DLGNRLQ J 03C K 00 G G 01 01O ZZZZ 02 D000
10	12	ISO Latin 1 Ital.	DLGNRLQ J 03C K 00 G G 01 6DD ZZZZ 02 D000
14.1	5	VT100	DLGNRLQ N 01N K 00 G G 00 01C ZZZZ 02 D000
14.1	5	DEC Supp.	DLGNRLQ N 01N K 00 G G 00 01O ZZZZ 02 D000
14.1	5	U.S. ASCII	DLGNRLQ N 01N K 00 G G 00 01U ZZZZ 02 D000
14.1	5	ISO Latin 1	DLGNRLQ N 01N K 00 G G 00 6DD ZZZZ 02 D000
8.		Type Family Name: Draft Plot	Type Family ID: DDRAFT0
10	12	U.S. ASCII	DDRAFT0 J 03C K 00 G G 00 01U ZZZZ 02 B000
10	12	DEC Supp.	DDRAFT0 J 03C K 00 G G 00 01O ZZZZ 02 B000
10	12	DEC Tech.	DDRAFT0 J 03C K 00 G G 00 01Q ZZZZ 02 B000
10	12	VT100	DDRAFT0 J 03C K 00 G G 00 01C ZZZZ 02 B000
10	12	ISO Latin 1	DDRAFT0 J 03C K 00 G G 00 6DD ZZZZ 02 B000
9.		Type Family Name: Low Density Plot	Type Family ID: DLODENS
10	10	U.S. ASCII	DLODENS J 03C K 00 G G 00 01U ZZZZ 02 Z0000
10.		Type Family Name: Correspondence Plot	Type Family ID: DCRRSPL
10	10	U.S. ASCII	DCRRSPL J 02S K 00 G G 00 01U ZZZZ 02 D000
10	10	DEC Supp.	DCRRSPL J 02S K 00 G G 00 01O ZZZZ 02 D000
10	10	VT100	DCRRSPL J 02S K 00 G G 00 01C ZZZZ 02 D000
10	10	ISO Latin 1	DCRRSPL J 02S K 00 G G 00 6DD ZZZZ 02 D000
10	10	VT100 Italic	DCRRSPL J 02S K 00 G G 01 01C ZZZZ 02 D000
10	10	DEC Supp. Ital.	DCRRSPL J 02S K 00 G G 01 01O ZZZZ 02 D000
10	10	ASCII Italic	DCRRSPL J 02S K 00 G G 01 01U ZZZZ 02 D000
10	10	ISO Latin 1 Ital.	DCRRSPL J 02S K 00 G G 01 6DD ZZZZ 02 D000

NOTE: The font file IDs are spaced for clarity. The spaces are not part of the actual ID string

D *Print Samples*

Introduction

This appendix contains sample programs that illustrate how to use LG control sequences and bar code control sequences in applications.

LG control sequences are described in Chapter 2, LG Emulation Control Codes Bar code control sequences are described in Chapter 4, Bar Codes

NOTE: The print samples in this appendix were printed on a DEC LG Emulation printer.

Creating Block Characters

The block character examples use the following escape sequences:

ESC[P1;P2'r Set Block Character Parameters (DECBCS)

ESC%SP1Start Block Character Mode (DECBLOCKC)

ESC%@Stop Block Character Mode

The following command sequences create the block characters shown in Figure 4:

Black Characters, White Background

CSI3;3;0;0;0'r

ESC% 1BLOCK CHARACTERSESC%@

White Characters, Black Background

CSI4;2;1;0;0'r

ESC% 1BLACK BACKGROUNDSESC%@

Landscape Character Orientation

CSI2;4;0;0;2'r

ESC% 1LANDSCAPESESC%@

BLOCK CHARACTERS

BLACK BACKGROUND

LANDSCAPE

Figure 4 Block Characters

Bar Codes

Bar code escape sequences determine the type of bar code, its attributes, and start and stop bar code printing. Bar code escape sequences are defined in Chapter 4.

The bar code examples in this section use the following escape sequences:

CSIP1;P2; ... P9'q Select Bar Code Attributes (DECSBCA)

ESC%SP0 Start Bar Coding (DECBARC)

ESC%@ Stop Bar Coding

Interleaved 2 of 5

The following command sequences create the bar code shown in Figure 5. The bar code is oriented portrait and coded to include human-readable characters in the OCR-A font.

CSI1;;;;;;;;;3'q

ESC% 00123456789ESC%@



Figure 5 Interleaved 2 of 5 Bar Code

Code 39

The following command sequences create the bar code shown in Figure 6. This bar code is rotated -90 degrees for landscape orientation and is coded to include human-readable characters in the currently active font.

CSI2;;;;;;;;;2;2'q

ESC% 00123456789ABCDEESC%@

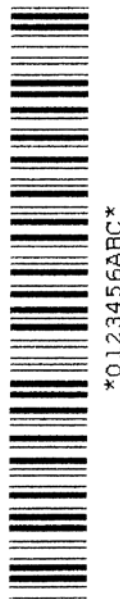

Figure 6 Code 39 Bar Code

Logos

The following command sequences create the logo graphic shown in Figure 7:

```
DCS0;1&t400016Square00086
250;1;1500\
333;1;250;1000;250\
333;1;250;333;333;250\
333;1;250;1000;250\
250;1;1500\
ST
CSI1&}
```

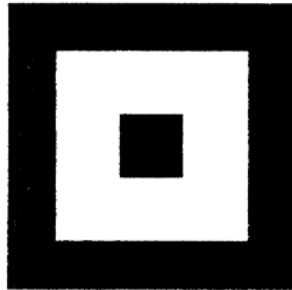

Figure 7 Box Logo

Sixel Graphics

The command sequences listed below create the sixel graphics output shown in Figure 8:

```
ESCP;;6q
!200~!200?!200~-
!200~!200?!200~-
!200~!200?!200~-
!200?!200~!200?-
!200?!200~!200?-
!200?!200~!200?-
!200?!200~!200?-
!200~!200?!200~-
!200~!90?~!18^~!90?!200~-
!200~!200?!200~-
!200?!200~!200?-
!200?!200~!200?-
!200?!200~!200?-
!200~!200?!200~-
!200~!200?!200~-
!200~!200?!200~-
ST
```



Figure 8 Sixel Graphic

Forms

The memo form shown in Figure 9 was created with the program illustrated below.

```
ESCcDCS0;3&p04Memo%00234
%1B[2g%1B[111%1B[5;127s%1B[2;66r%1B[45u
*****%0D%0A
* d i g i t a l *%09INTEROFFICE MEMO%0D%0A
*****%0D%0A%0A

TO:@%09DATE:@
%09FROM:@
%09DEPT:@
%09EXT: @
%09LOC/MAIL STOP:@
%09ENG.NET.:%1B[ 2e
SUBJECT:@%0D%1B[ 2e
@ST

DCS0;64&rMemoSTTest and Verification@20 March 1995
@Jane Doe
@Engineering
@555-0009
@ENG/HDO
@NOED: : SMITHDCS0&qMemoST
@LG PERFORMANCE ANALYSIS
@Please do a performance analysis on the following
functions.
ESC# 1
```

* d i g i t a l *

INTEROFFICE MEMO

TO: Test and Verification

DATE: 20 March 1995
FROM: Jane Doe
DEPT: Engineering
EXT: 555-0009
LOC/MAIL STOP: ENG/HDO
ENG. NET.: NODE::SMITH

SUBJECT: LG04 PERFORMANCE ANALYSIS

Please do a performance analysis on the following functions.

Figure 9 Memo Form

The payroll deduction form shown in Figure 10 was created with the program illustrated below.

CSI 300 ; 5000s CSI300;6300r

DCS 0 ; 3&p07Payroll^~01367
^1B [11h^1B [7 l

^1B [0 ; 200 ; 1100 ; 4600 ; 5!
^1B [0 ; 4800 ; 1100 ; 5000 ; 5!
^1B [0 ; 200 ; 6100 ; 4605 ; 5!
^1B [0 ; 200 ; 1100 ; 5000 ; 5!

^1B [300 ` ^1B [1300d ^1B [3&}
^1B [2 ; 2 ; 0 ; 0 ; 0 ` r
^1B [300 ` ^1B [1500d^09^09^09^1B [2 ; 2 ; 0 ; 0 ; 0 'r ^1B% 1PAYROLL
DEDUCTIONS^1B%@
^1B [0 ; 300 ; 1900 ; 4400 ; 10!
^1B [0 ; 300 ; 2600 ; 4400 ; 10!
^1B [1600 ` ^1B [2000d ^1B [2 ; 1 ; 0 ; 0 ; 0 ' r ^1B% 1INSTRUCTIONS
^1B%@
^1B [300 ` ^1B [2300d1. Complete the Appropriate section(s) below.
^1B [300 ` ^1B [2400d2. Be sure to sign,date and write your employee number
^1B [300 ` ^1B [2500d in each section you complete.
^1B [600 ` ^1B [2700d^1B% 1EMPLOYEE'S WITHHOLDING EXEMPTION^1B%@

^1B [0 ; 300 ; 2900 ; 2000 ; 10!
^1B [0 ; 300 ; 4300 ; 2000 ; 10!
^1B [0 ; 300 ; 2900 ; 1400 ; 10!
^1B [0 ; 2300 ; 2900 ; 1400 ; 10!
^1B [0 ; 300 ; 3100 ; 2000 ; 10!

^1B [0 ; 420 ; 3300 ; 200 ; 10!
^1B [0 ; 420 ; 3500 ; 200 ; 10!
^1B [1 ; 420 ; 3300 ; 200 ; 10!
^1B [1 ; 620 ; 3300 ; 200 ; 10!

^1B [0 ; 420 ; 3600 ; 200 ; 10!
^1B [0 ; 420 ; 3800 ; 200 ; 10!
^1B [1 ; 420 ; 3600 ; 200 ; 10!
^1B [1 ; 620 ; 3600 ; 200 ; 10!

^1B [0;420;3900;200;10!
^1B [0;420;4100;200;10!
^1B [1;420;3900;200;10!
^1B [1;620;3900;200;10!

^1B [0 ; 300 ; 4800 ; 2000 ; 10!
^1B [2300 ` ^1B[4790d Date
^1B [0 ; 2600 ; 4800 ; 1000 ; '10!

^1B [1050 `^1B [3050dTax Status
^1B [650 `^1B [3400dSingle
^1B [650 `^1B [3700dMarried
^1B [650 `^1B [4000dMarried/higher single rate
^1B [300 `^1B[5200dEmployee Signature

^1B [0 ; ; ; ; ; 1 ; 2 'q
^1B [2400 ` ^ 1B [5500d
^1B% 00123456789 ^1B% @

^1B [470 ` ^1B [3350d ^1B% 1~ ^1B% @
^1B [470 ` ^1B [3650d ^1B% 1~ ^1B% @
^1B [470 `^1B [3950d ^1B% 1~^1B% @
^1B [300 ` ^1B [4790d~
^1B [2700`^1B [4790d~
^0

ST

CSI 18m CSI 70h

DCS0;126&rPayroll STX~~~John Q.Smith~Jan28, 1995 ESC#1

PAYROLL DEDUCTIONS

INSTRUCTIONS

1. Complete the Appropriate section(s) below.
2. Be sure to sign, date and write your employee number in each section you complete.

EMPLOYEE'S WITHHOLDING EXEMPTION

Tax Status	
<input checked="" type="checkbox"/>	Single
<input type="checkbox"/>	Married
<input type="checkbox"/>	Married/higher single rate

John Q. Smith Date Jan 28, 1995

Employee Signature



0123456789

Figure 10 Payroll Deduction form

Vertical Format Unit (VFU)

The following command sequences create the vertical formatting shown in Figure 11:

```
ESC[<1hA@@@@@B@@@@@D@@@@` ESC[<1l  
ESC[002&y ESC[5`Channel 3 line 7  
ESC[900&y ESC[5`TOF line 1  
ESC[002&y ESC[25`Channel 3 line 7  
ESC[901&y ESC[25`Channel 2 line 4  
ESC[011&y ESC[5`Bottom of form  
CR FF
```

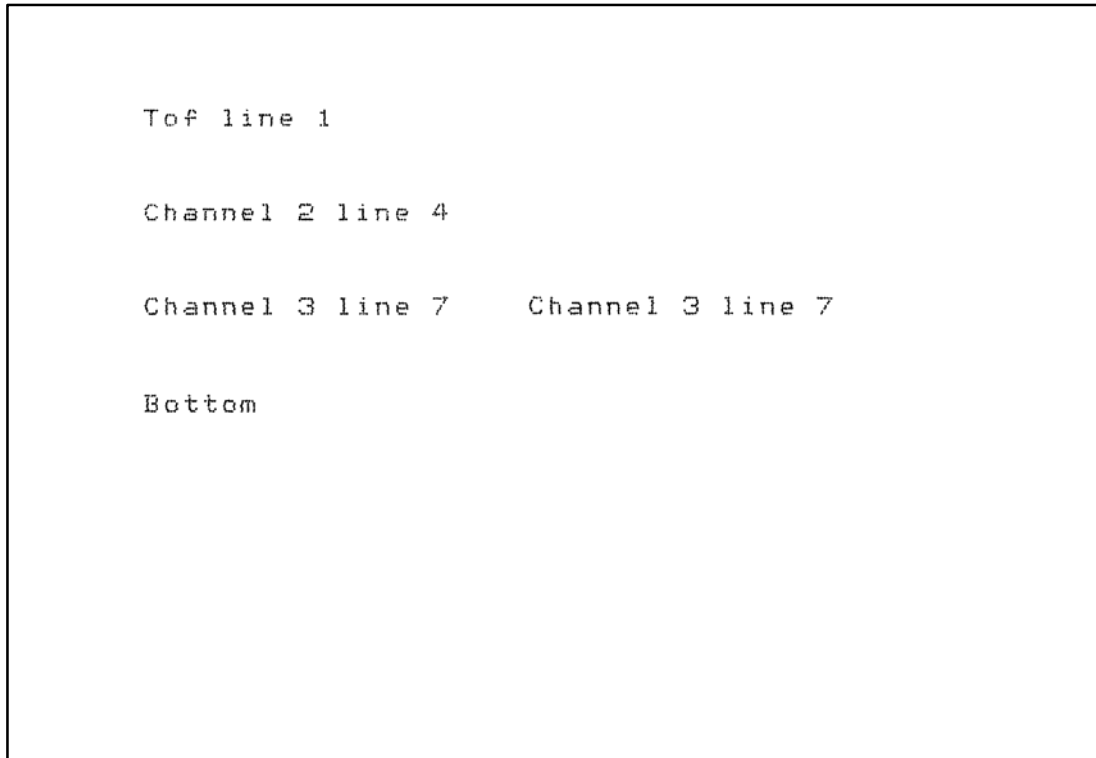

Figure 11 Vertical Format Unit (VFU)

E *Glossary*

A

active column	The horizontal location on the paper where the next character will print. After printing a character, the printer advances the active column.
active line	The vertical location on the paper where the next character will print. After printing a line, the printer advances the active line.
active position	The position on the paper where the next character will print. The active position is defined by the horizontal position (active column) and the vertical position (active line).
ASCII	<i>Abbrev.</i> for American Standard Code for Information Interchange.
attributes, print	Operations performed on text that alter its appearance but do not change the font. Examples: underlining, superscripting, bold, etc.

B

bar code	A printed code consisting of parallel bars of varied width and spacing and designed to be read by a one- dimensional scanning device.
baud	A unit of speed that measures the rate at which information is transferred. Baud rate is the reciprocal of the length in seconds of the shortest pulse used to carry data. For example, a system in which the shortest pulse is 1/1200 second operates at 1200 baud. On RS- 232 serial lines, the baud rate equals the data flow rate in bits per second (bps). To communicate properly, a printer must be configured to operate at the same baud rate as its host computer.
bit	<i>Contraction of binary digit.</i> A digit in the binary (base 2) number system: 0 or 1. A bit is the smallest unit of storage in a digital computer, where 0 and 1 are represented by different voltages. Groups of bits form other units of storage called <i>nibbles, bytes, and words.</i>
bold	A dark thick character weight produced by a double strike print method. <i>See also</i> shadow printing, character weight.
Boot-up	The start-up procedure which causes a computer

operating system to be loaded into main memory.

buffer A reserved area in printer memory that data is written to and read from during data transfers.

C

character cell The invisible rectangular space occupied by a character, including the white space around the character. Used as a unit of spacing. The height of a cell is equal to the current line spacing, and the width of a cell is equal to the current character spacing.

character proportion The ratio of character height to character width. See also *compressed and expanded*.

character set Instructions telling the printer how to construct a related group of printable characters, including symbols, punctuation, numbers, diacritical markings, and alphabet characters. Each character in a set is assigned a unique address in memory.

character weight The degree of lightness and thickness of printed text. For example: Bold refers to a heavy or thick character weight. Medium, normal, or book weight refer to the character weight used in this sentence.

control sequence Two or more bytes that instruct the printer to perform a special function. A control sequence begins with the control sequence introducer, CSI, in an 8-bit data environment. A control sequence can also be an escape sequence, however, because the 8-bit CSI control character can be represented by the 7-bit escape sequence, ESC [.

compressed Refers to a typeface with a smaller than normal character width, but no change to character height.

cpi *Abbrev. for* characters per inch: a measurement of monospaced fonts indicating the horizontal character density. For example, 10 cpi is 10 characters produced in a one-inch (horizontal) space.

CSI *Abbrev. for* Control Sequence Introducer: A non-printing control character (decimal 155, hex 9B) that is always the first byte of a control sequence in an 8-bit data environment. See also Control sequence.

D

data bits Binary information sent to the printer; a character set grouping containing letters, digits, and punctuation marks to be printed, or control codes to move paper or position the text on the page.

decipoint One tenth of a point. A unit of measurement equal to 1/ 720 inch. See *also* point.

default A value, parameter, attribute, or option assigned by a program or system when another is not specified by the user.

diagnostic	Pertains to the detection and isolation of printer malfunctions or mistakes.
DIP	Dual In-line Package: a method of packaging semiconductor components in rectangular cases with parallel rows of electrical contacts.
DIP switch	A DIP equipped with toggle switches.
disable	To deactivate or set to OFF.
DP	<i>Abbrev. for data processing font (see HS).</i>

E

EIA/TIA	<i>Abbrev. for Electronics Industries Association.</i>
Elite	A name indicating a monospaced font with 12 cpi pitch (and usually 10 points in height).
Em	A font width term equal to the maximum character width obtainable in a given font. (Derived from the width of an uppercase M, usually the widest character in a set.)
emulation	Refers to the ability of a printer to execute the commands of another printer language or protocol.
En	A font width term equal to one half em.
enable	To activate or set to ON.
escape sequence	Two or more bytes that describe a specific printer control function. In an escape sequence, the first byte is always the ASCII ESC character (decimal 27, hex 1B). <i>See also control sequence.</i>
expanded	Refers to larger-than-normal character width with no change in character height.

F

false	Off or zero. <i>Compare true.</i>
family (or type)	A set of all variations and sizes of a type style.
fixed-pitch fonts	<i>See font, monospaced.</i>
font	The complete set of a given size of type, including characters, symbols, figures, punctuation marks, ligatures, signs, and accents. To fully describe a font, seven characteristics are usually specified: <ol style="list-style-type: none"> 1) Type family 2) Spacing (proportional or monospaced) 3) Type size (12 point, 14 point, etc.) 4) Scale factor (character height/width ratio) 5) Type style 6) Character weight 7) Character proportion (normal, condensed, expanded).
font name	<i>See typeface.</i>

font pattern	A font pattern is the matrix of pels which represents a character, symbol, or image.
font, landscape	A font printed parallel to the long edge of a page, or a font capable of being produced on a landscape page orientation.
font, monospaced	Also called fixed-pitch fonts. Every character, regardless of actual horizontal size, occupies the same amount of font pattern space. All monospaced fonts use specific pitch size settings. Monospaced fonts are sometimes used when strict character alignment is desired (tables, charts, spreadsheets, etc.).
font, portrait	A font printed parallel to the short edge of a page.
font, proportional	A font in which the width of the character cell varies with the width of the character. For example, "i" takes less space to print than "m." Using proportional fonts generally increases the readability of printed documents, giving text a typeset appearance. This manual is printed in proportional fonts.
font weight	<i>See character weight.</i>
font width	The measurement of the width of a character cell in dots.

G

GL Characters	Graphic left: Graphic left characters map half of the character set table. The GL characters reside at 0 - 127 hex and comprise the ASCII portion of the table.
GR Characters	Graphic right: Graphic right characters map half of the character set table. The GR characters reside at 128 - 255 hex and comprise the LG portion of the table.

H

hex codes	Codes based on a numeral system with a radix of 16.
hex dump	A hex dump is a translation of all host interface data to its hexadecimal equivalent. A hex dump is a printer self-test typically used to troubleshoot printer data reception problems.
HGS	<i>Abbrev. for Horizontal Grid Size</i>
host computer	The host computer stores, processes, and sends data to be printed, and which communicates directly with the printer. The term host indicates the controlling computer, since modern printers are themselves microprocessor-controlled computer systems.
Hz	<i>Abbrev. for Hertz. Cycles per second, a measure of frequency.</i>

I

IGP	Intelligent Graphics Processor. An interface that converts graphics commands received from the host computer to binary plot data that is usable by the printer.
-----	-----------------------------------------------------------------------------------------------------------------------------------------------------------------

interface	The hardware components used to link two devices by common physical interconnection, signal, and functional characteristics. <i>See also Printer Interface.</i>
invoke	To put into effect or operation.
ipm	<i>Abbrev. for inches per minute: The speed at which graphics are plotted.</i>
italic	A type style in which the characters are slanted. <i>This sentence is set in italics. Compare Roman.</i>

L

landscape	Printed perpendicular to the paper motion.
LCD	<i>Abbrev. for liquid-crystal display.</i> The LCD is located on the control panel. Its purpose is to communicate information to the operator concerning the operating state of the printer.
LED	<i>Abbrev. for light-emitting diode.</i> The printer control panel has LEDs that indicate the status of the printer to the operator.
logical link	The parameters that specify data transfer, control, or communication operations.
lpi	<i>Abbrev. for lines per inch.</i> A measurement indicating the vertical spacing between successive lines of text. For example, 8 lpi means eight lines of text for every vertical inch.
lpm	<i>Abbrev. for lines per minute.</i> A measurement of the print speed of a line printer printing in text print mode.

M

macro	A macro is a collection of control codes, escape sequences, and data whose execution can be initiated by using a single command. This information is downloaded into the printer.
memory	<i>See RAM.</i>
monospaced	<i>See font, monospaced.</i>

N

NLQ	<i>Abbrev. for near letter quality font.</i>
non impact	Printing which does not result from any mechanical impact onto the paper. Example: an electrophotographic printer.
nonvolatile memory	Nonvolatile memory stores variables that must be preserved when the printer is turned off, such as configuration parameters and printer usage statistics. Nonvolatile memory is preserved by means of an independent, battery-operated power supply. When printer power is turned off, the battery supplies the power needed to keep stored data active.

NOVRAM *Acronym for nonvolatile random access memory. See also nonvolatile memory.*

O

OCR Optical Character Recognition is the process by which a machine reads characters printed in a special standardized font. Data are read by a photoelectric optical scanner and recorded on magnetic tape or disk. OCR-A and OCR-B are two widely used fonts.

off-line The non-printing operational state of the printer. When the printer is off-line, communication between the printer and the host computer is temporarily stopped and the message "Off-line/Emulation" appears on the display. Non-printing operations, such as printer configuration, paper loading, changing the ribbon, etc., are done with the printer off-line.

on-line The printing state. When the printer is on-line, it is ready to receive data and control commands from the host computer, and prints the data immediately. "On- line" appears on the message display and the control panel status lamps illuminate continuously.

ON LINE A switch on the operator control panel that toggles the printer between the on-line and off-line states.

P

parity (check) Parity checking is the addition of non-data bits to data, resulting in the number of 1 bits being either always even or always odd. Parity is used to detect transmission errors. Parity represents the value in the check digit of the received or transmitted data.

parsing Parsing is the process of separating a programming statement into basic units that can be translated into machine instructions. A printer can recover from an erroneous code sequence by performing as much of the function as possible or, parsing the valid parameter from the invalid.

PCBA *Abbrev. for printed circuit board assembly.*

pel *See pixel.*

PI Paper instruction: A signal from the host with the same timing and polarity as the data lines.

Pica A name indicating a monospaced font with a pitch of 10 cpi and usually a 12 point height. Pica is also used in typography as a unit of measurement: 1 pica = 1/6 inch.

pin configuration Establishes the physical attachment and protocol conversion connections for the host interface.

pitch The number of text characters printed per horizontal inch. Specified in characters per inch or cpi.

pixel	Acronym of picture element or picture cell. Also called a pel. The smallest displayable picture element on a video monitor or printable unit in a printer.
point	A unit of measure in printing and typography, used to specify type sizes, heights of font characters, etc. There are 72 points in a vertical inch; thus, one point equals 1/72 inch, or approximately 0.0138 inch. Examples: This is 6 point type. This is 11 point type. This is 16 point type.
port	A channel used for receiving data from or transmitting data to one or more external devices.
printer configuration	The operating properties that define how the printer responds to signals and commands received from the host computer. These properties are set to match the operating characteristics of the host computer system.
printer interface	The point where the data line from the host computer plugs into the printer.
protocol	A set of rules or conventions governing the exchange of information between computer systems. For computer printers, a protocol is the coding convention used to convey and print data. A printer protocol includes character codes, printer function codes, and machine-to-machine communication codes.

R

RAM	Acronym for random-access memory. Also called “main memory” or “working memory.” RAM is the active memory of a printer, into which programs are loaded. This memory can be read from or written to at any time. RAM is also termed “volatile” because whatever information is in RAM is lost when power is turned off or interrupted. See also ROM .
read	To retrieve data from memory or mass storage (hard disk, floppy diskette, RAM, etc.).
reset	To turn off, deactivate, disable, or return to a previous state.
resolution	A measure expressing the number of component units in a given range used to create an image; in printing, expressed as the number of dots per inch (dpi) horizontally and vertically.
ROCS	Return from Other Coding System: A control sequence that allows you to return the printer to the previous emulation from any point in the printer's configuration.
ROM	<i>Acronym for read-only memory.</i> Programs, instructions, and routines permanently stored in the printer. Information in ROM is not lost when power is turned off. ROM cannot be written to—hence the term “read-only.” See also RAM.

roman A type style in which characters are upright. This sentence is printed in a roman type style. *Compare Italic.*

S

sans serif A typeface or font in which the characters do not have serifs. This font is sans serif.

serial communications The sequential transmission of data, in which each element (bit) is transferred in succession.

serial matrix Refers to the manner in which text characters are printed. In a serial matrix printer, a moving printhead uses pins to form whole characters one at a time and one after the other. The pins print dots according to programmed matrix patterns. Although data are sent to the printer interface either a serially or in parallel, the printhead receives the data serially in order to form each character. The DEC LG Emulation printer also forms characters with dots in matrix patterns, but it feeds print data in parallel to many hammers mounted on a rapidly oscillating shuttle. The hammers fire simultaneously to print entire lines at a time.

serif A short line stemming from and at an angle to the upper or lower end of the stroke of a letter or number character.

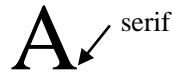

set To turn on, activate, invoke, or enable.

SFCC *Abbrev. for special function control character.* The first character in a printer command sequence. In P-Series emulation mode, you can select one of five characters as the SFCC. In Epson FX and Proprinter emulation mode, the SFCC must always be the ASCII ESC character. See also **command sequence** and **escape sequence**.

shadow printing A typeface with a heavy line thickness produced by doublestriking. The printer forms a character, then prints it again, but fractionally offset from the first position. See also *bold, character weight*.

sixel A vertical column consisting of six pixels and treated as a unit in graphics applications.

size, type See *point*.

slewing Rapid vertical paper movement.

SOCS Select Other Coding System: A control sequence that allows you to enable another emulation.

spacing See *font, proportional and font, monospaced*.

SSCC *Abbrev. for SuperSet Control Code. It is of the form | } ; and is used to execute superset commands.*

start bit	In serial data transfer, a signal indicating the beginning of a character or data element.
stop bit	In serial data transfer, a signal indicating the end of a character or data element.
string	Two or more bytes of data or code treated as a unit.
style, type	See <i>type style</i> .
superset commands	Commands which are an extension to the base LinePrinter+ printer protocol, such as the bar code commands for the Epson FX protocol.
symbol set	See <i>character set</i> .

T

type family	See typeface .
type size	See point .
type style	Refers to either the upright or italic character style in a specific font family. Roman is upright, <i>italic is slanted</i> .
typeface	A descriptive name or brand name that identifies a particular design of type. Examples are: Courier, Helvetica, and Swiss. Also called type family.
typographic font	See font, proportional .

V

VFU	<i>Abbrev. for vertical format unit.</i>
-----	------------------------------------------

W

weight	See <i>character weight</i> .
write	To store data to memory (RAM) or to mass storage (hard disk, floppy diskette, etc.).

X

X-off	A character transmitted by the printer announcing that the printer is off-line or the buffer is almost full (DC3 - 13 Hex).
X-on	A character transmitted by the printer announcing that the printer is on-line or the buffer is almost empty (DC1 - 11 Hex).

F *Contact Information*

Printronix Customer Support Center

IMPORTANT Please have the following information available prior to calling the Printronix Customer Support Center:

- Model number
- Serial number (located on the back of the printer)
- Installed options (i.e., interface and host type if applicable to the problem)
- Configuration printout: (See "Printing A Configuration") in your printers Administrator's manual.
- Is the problem with a new install or an existing printer?
- Description of the problem (be specific)
- Good and bad samples that clearly show the problem (faxing or emailing of these samples may be required)

Americas	(714) 368-2686
Europe, Middle East, and Africa	(31) 24 6489 311
Asia Pacific	(65) 6548 4114
China	(86) 800-999-6836

<http://www.printronix.com/support.aspx>

Printronix Supplies Department

Contact the Printronix Supplies Department for genuine Printronix supplies.

Americas	(800) 733-1900
Europe, Middle East, and Africa	(33) 1 46 25 19 07
Asia Pacific	(65) 6548 4100
China	(86) 400-886-5598
India	1800 102 7869

<http://www.printronix.com/supplies-parts.aspx>

Corporate Offices

Printronic, LLC.
6440 Oak Canyon RD, Suite 200
Irvine, CA 92618
U.S.A.
Phone: (714) 368-2300
Fax: (714) 368-2600

Printronic LLC.
c/o Printronix Nederland BV
Bijsterhuizen 11-38
6546 AS Nijmegen
The Netherlands
Phone: (31) 24 6489489
Fax: (31) 24 6489499

Printronic Schweiz GmbH
3 Changi Business Park Vista
#04-05 AkzoNobel House
Singapore 486051
Phone: (65) 6548 4100
Fax: (65) 6548 4111

Printronic Commercial (Shanghai) Co. Ltd.
Room 903, 9th Floor
No. 199, North Xizang Road
200070 Shanghai P.R. China
Phone: (86) 400 886 5598
Fax: (8621) 61171256

Printronic India Pvt Ltd
B-808/809, BSEL Tech Park
8th Floor, Sector 30A
Vashi Navi Mumbai 400705
India
Toll Free No.: 1800 102 7896
Fax: (9122) 4158 5555

Visit the Printronix web site at www.primtronix.com