

# PRINTRONIX®

---

Line Printer Plus®  
*Programmer's Reference Manual*

---

*Line Matrix Series Printers*

# Trademark Acknowledgements

IBM and Proprinter are registered trademarks of the International Business Machines Corp.

IGP, LinePrinter Plus, PGL and Printronix are registered trademarks of Printronix, LLC.

Code V is a trademark of Quality Micro Systems, Inc.

HP is a registered trademark of Hewlett-Packard Company. Epson is a registered trademark of Seiko Epson Corporation.

Dataproducts is a registered trademark of Dataproducts Corporation. Centronics is a registered trademark of Genicom Corporation.

This product uses Intellifont Scalable typefaces and Intellifont technology. Intellifont is a registered trademark of Agfa Division, Miles Incorporated (Agfa).

CG, Garth Graphic, Intellifont, and Type Director are registered trademarks, and Shannon and CG Triumvirate are trademarks of Agfa Division, Miles Incorporated (Agfa). CG Bodoni, CG Century Schoolbook, CG Goudy Old Style, CG Melliza, Microstyle, CG Omega, and CG Palacio are products of Agfa Corporation. CG Times, based on Times New Roman under license from The Monotype Corporation Plc is a product of Agfa.

Univers is a registered trademark of Linotype AG and/or its subsidiaries.

Letraset is a registered trademark, and Aachen, Revue and University Roman are trademarks of Esselte Pendaflex Corporation.

Futura is a registered trademark of Fundición Tipográfica Neufville, S.A.

ITC Avant Garde Gothic, ITC Benguiat, ITC Bookman, ITC Century, ITC Cheltenham, ITC Clearface, ITC Galliard, ITC Korinna, ITC Lubalin Graph, ITC Souvenir, ITC Tiepolo, ITC Zapf Chancery, and ITC Zapf Dingbats are registered trademarks of International Typeface Corporation.

Albertus, Gill Sans, and Times New Roman are registered trademarks, and Monotype Baskerville is a trademark of The Monotype Corporation Plc, registered in the U.S. Pat. and TM office and elsewhere.

Hiroshige and Marigold are trademarks of AlphaOmega Typography, Inc.

Printronix, LLC. makes no representations or warranties of any kind regarding this material, including, but not limited to, implied warranties of merchantability and fitness for a particular purpose. Printronix, LLC. shall not be held responsible for errors contained herein or any omissions from this material or for any damages, whether direct, indirect, incidental or consequential, in connection with the furnishing, distribution, performance or use of this material. The information in this manual is subject to change without notice.

This document contains proprietary information protected by copyright. No part of this document may be reproduced, copied, translated or incorporated in any other material in any form or by any means, whether manual, graphic, electronic, mechanical or otherwise, without the prior written consent of Printronix, LLC.

COPYRIGHT © 2007, 2013, PRINTRONIX, LLC.

All rights reserved.

# Table of Contents

1	Introduction .....	13
	About this Manual .....	13
	Warnings And Special Information .....	14
2	IBM Proprinter III XL Emulation .....	15
	Overview .....	15
	Proprinter III XL Emulation Default Settings .....	15
	Configuring the Proprinter III XL Emulation with Control Codes .....	17
	Format for Control Code Descriptions .....	17
	Escape Control Codes Overview .....	17
	Graphics Control Codes Overview .....	18
	The Control Codes .....	19
	Backspace .....	22
	Bell .....	22
	Bit Image Mode, Single Density (Normal Speed) .....	22
	Bit Image Mode, Double Density (Half Speed) .....	23
	Bit Image Mode, Double Density (Normal Speed) .....	23
	Bit Image Mode, Quadruple Density (Half Speed) .....	23
	Bold Printing .....	24
	Bold Printing, Cancel .....	24
	Cancel .....	25
	Carriage Return .....	25
	Carriage Return Set .....	25
	Character Pitch 12 cpi .....	26
	Character Set Select: Set 1 (A) .....	26
	Character Set Select: Set 2 (B) .....	26
	Condensed Print .....	26
	Condensed Print Cancel .....	27
	Deselect Printer .....	27
	Double Wide Print .....	28
	Double Wide Print (One Line Only) .....	29
	Double Wide Print (One Line Only) Cancel .....	29
	Emphasized Print .....	29
	Emphasized Print Cancel .....	30
	Form Feed .....	30
	Forms Length Set in Inches .....	30
	Forms Length Set in Lines .....	31
	Initialize Parameters .....	31
	Line Feed .....	33
	Line Feed $n/216$ Inch (One Line Only) .....	33

Line Spacing 1/8 Inch (8 lpi) .....	34
Line Spacing 7/72 Inch (10.3 lpi) .....	34
Line Spacing <i>n</i> /72 Inch (Executes) .....	35
Line Spacing <i>n</i> /72 Inch (Storage) .....	35
Line Spacing <i>n</i> /216 Inch .....	36
Margin, Bottom .....	36
Margin, Bottom (Cancel) .....	37
Margins, Horizontal .....	37
Overscoring .....	37
Print All Characters .....	38
Print Next Character .....	38
Print Mode .....	38
Print Quality .....	39
Proportional Spacing .....	40
Select Attributes .....	40
Superscript/Subscript Printing .....	41
Superscript/Subscript Printing, Cancel .....	42
Super-Set Commands .....	42
Set Top-of-Form .....	42
Tab, Horizontal .....	43
Tab Set/Clear, Horizontal .....	43
Tab, Vertical .....	44
Tab Set/Clear, Vertical .....	44
Tabs, Clear All (Return to default) .....	45
Underline .....	45
Unidirectional Printing .....	45
<b>3 Epson FX-1050 Emulation .....</b>	<b>47</b>
Overview .....	47
Default Values and States .....	47
Epson Emulation Exceptions and Differences .....	48
Epson Character Sets .....	49
Configuring the Epson FX-1050 Emulation with Control Codes .....	50
Format for Control Code Descriptions .....	50
Escape Sequences .....	50
Set and Reset Codes .....	50
NUL Code .....	51
Print Modes Supported for Character Sets .....	51
The Control Codes .....	53
Backspace .....	55
Bell .....	56
Cancel Line .....	56

Carriage Return.....	56
Character Pitch 10 CPI.....	56
Character Pitch 12 CPI.....	57
Character Pitch 15 CPI.....	57
Character Set Select: International Languages .....	57
Clear Bit 7 of Incoming Data Bytes to 0 .....	58
Condensed Print .....	59
Condensed Print Reset .....	59
Cut-Sheet / Paper Feed Control.....	60
Define a Download Character .....	60
Delete Character .....	60
Double High Print, Set/Reset.....	60
Double Strike.....	61
Double Strike, Cancel .....	61
Double Wide Print .....	61
Double Wide Print (1 Line) .....	62
Double Wide Print (1 Line), Cancel.....	62
Emphasized Print.....	63
Emphasized Print, Cancel.....	63
Enable Printing Hex Codes 00-1F and 80-9F .....	63
Form Feed.....	64
Graphics, Standard Density .....	66
Graphics, Double Density .....	66
Graphics, Double Density Double Speed.....	67
Graphics, Quadruple Density .....	67
Half Speed Mode, On/Off.....	68
Horizontal Tab Execute .....	68
Horizontal Tab Set/Release.....	68
Initialize Printer.....	69
Italic Printing.....	69
Italic Printing, Cancel.....	69
Line Feed .....	69
Line Feed $n/216$ Inch .....	70
Line Spacing 1/6 Inch (6 lpi).....	70
Line Spacing 1/8 Inch (8 lpi).....	71
Line Spacing 7/72 Inch .....	71
Line Spacing $n/216$ Inch .....	71
Line Spacing $n/72$ Inch .....	72
Make Hex 80-9F Control Codes.....	72
Make Hex 80-9F Printable .....	73
Master Print Select.....	75
Paper Out Detection, Enable .....	75
Paper Out Detection, Disable.....	75

Pass Bit 7 from Host .....	76
Printer Select.....	76
Printer Deselect.....	76
Reassign Graphics Mode.....	76
Remove Downloaded Characters .....	77
Reverse Line Spacing n/216 Inch .....	77
Select Graphics Mode .....	77
Select Italic Character Set .....	78
Select 9-Pin Graphics Mode .....	79
Select Print Quality .....	79
Select/Deselect Proportional Spacing.....	79
Select Serif or Sans Serif Font .....	80
Select User-Defined Font.....	80
Select Vertical Tab Channel.....	80
Set Absolute Horizontal Print Position in 1/60 Inch .....	80
Set Bit 7 of Incoming Data Bytes to 1 .....	81
Set Relative Horizontal Print Position in 1/120 Inch .....	81
Set Intercharacter Spacing in 1/120 Inch .....	81
Set Margin, Left.....	81
Set Margin, Right .....	82
Set Forms Length by Lines.....	82
Set Form Length in Inches .....	83
Set Vertical Tabs in Channels .....	83
Skip Over Perforation .....	84
Skip Over Perforation, Cancel.....	84
Superscript/Subscript Printing .....	84
Superscript/Subscript Printing, Cancel.....	85
Super-Set Commands.....	85
Underline.....	85
Unidirectional Printing, 1 Line .....	86
Unidirectional Printing, Set/Reset.....	86
Vertical Tab, Execute.....	86
Vertical Tab, Set/Clear.....	87
<b>4 P-Series Printer Emulation .....</b>	<b>89</b>
Overview.....	89
P-Series Default Values and States .....	89
Configuring the P-Series Emulation with Control Codes .....	91
Format for Control Code Descriptions.....	91
Special Function Control Code (SFCC) Header .....	92
The Control Codes.....	95
Backspace.....	97
Bell.....	97

Bold Print.....	97
Bold Print Reset .....	98
Carriage Return.....	98
Character Set Select.....	99
Characters 80-9F (Control Codes) .....	101
Characters 80-9F (Printable Symbols).....	101
Character Set Select: ECMA 94 Latin 1 Extended .....	101
Character Set Select: International Languages .....	103
Elongated (Double High) Print, 1 Line Only .....	104
Elongated (Double High) Print, Set/Reset.....	105
Emphasized Print.....	105
Emphasized Print Reset .....	106
Emulation Reset.....	106
Expanded Print (Double Wide).....	106
Expanded Print (Double Wide), 1 Line Only .....	107
Extended Character Set .....	107
Extended Character Set Cancel (Primary Set Select) .....	108
Form Feed.....	108
Forms Length Set (Inches) .....	109
Forms Length Set (Lines) .....	109
Line Feed .....	110
Line Spacing 1/6 Inch (6 lpi).....	110
Line Spacing 1/8 Inch (8 lpi).....	111
Line Spacing 8 or 10.3 lpi (1 Line Only).....	111
Line Spacing 7/72 Inch .....	112
Line Spacing $n/72$ Inch .....	112
Line Spacing $n/216$ Inch .....	113
Overscoring.....	113
Plot, Even Dot (P-Series High Density Graphics) .....	114
Plot, Odd Dot (P-Series Normal Density Graphics) .....	114
Print Mode/Pitch Selection.....	114
Reverse.....	117
Select Attributes .....	117
Superscript/Subscript Printing .....	118
Superscript/Subscript Printing Reset.....	119
Super-Set Commands.....	119
Underline.....	119
VFU Commands (P-Series).....	120
Vertical Tab .....	120
<b>5 Serial Matrix Printer Emulation .....</b>	<b>121</b>
Overview.....	121
Serial Matrix Default Values and States.....	121

Configuring the Serial Matrix Emulation with Control Codes.....	123
Format for Control Code Descriptions.....	123
Special Function Control Code (SFCC) .....	124
Attribute Set and Reset Codes.....	124
NUL Code .....	124
Print Modes Supported for Character Sets .....	124
The Control Codes.....	127
Backspace.....	129
Bell.....	129
Bit Image Mode, Single Density .....	129
Bit Image Mode, Double Density.....	130
Bit Image Mode, Double Density Double Speed .....	130
Bit Image Mode, Quadruple Density .....	130
Bold Print Set .....	131
Bold Print Reset .....	131
Cancel .....	132
Carriage Return.....	132
Character Pitch 10 CPI .....	133
Character Pitch 12 CPI .....	133
Character Set Select.....	133
Characters 80-9F (Control Codes) .....	135
Characters 80-9F (Printable Symbols).....	135
Characters 80-9F (Printable Symbols).....	135
Character Set Select: International Languages .....	136
Condensed Print .....	137
Condensed Print Reset .....	137
Delete .....	137
Elongated (Double High) Print (One Line Only) .....	138
Elongated (Double High) Print, Set/Reset.....	138
Emphasized Print.....	139
Emphasized Print Reset .....	139
Emulation Reset.....	139
Expanded (Double Wide) Print .....	140
Expanded (Double Wide) Print (One Line Only) .....	140
Extended Character Set .....	141
Extended Character Set Cancel (Primary Character Set Select) .....	141
Form Feed.....	141
Forms Length Set (Inches) .....	142
Forms Length Set (Lines) .....	142
Horizontal Tab .....	143
Horizontal Tab Set .....	143
Line Feed .....	144
Line Feed $n/216$ Inch (One Line Only) .....	144



Line Spacing 1/6 Inch (6 lpi).....	145
Line Spacing 1/8 Inch (8 lpi).....	145
Line Spacing 7/72 Inch.....	146
Line Spacing $n/72$ Inch.....	146
Line Spacing $n/216$ Inch.....	147
Overscoring.....	147
Print Mode/Pitch Selection.....	148
Printer Select.....	150
Printer Deselect.....	150
Reverse.....	150
Skip-Over Perforation.....	151
Skip-Over Perforation Cancel.....	151
Superscript/Subscript Printing.....	151
Superscript/Subscript Printing Reset.....	152
Super-Set Commands.....	152
Underline.....	153
Vertical Tab.....	153
Vertical Tab, Set/Clear.....	154
<b>6 P-Series XQ Variant Printer Emulation.....</b>	<b>155</b>
Overview.....	155
P-Series XQ Variant Default Values and States.....	155
Configuring the XQ Variant Emulation with Control Codes.....	157
Format for Control Code Descriptions.....	157
Edit Mode.....	157
NUL Code.....	158
The Control Codes.....	158
Alternate Character Set Deselect (Shift In).....	159
Alternate Character Set Select (Shift Out).....	159
Carriage Return.....	160
Compressed Print.....	160
Delete.....	161
Electronic Vertical Format Unit (EVFU).....	161
Elongated Characters (Double High Print).....	162
Form Feed.....	162
Line Feed.....	163
Line Spacing (8 or 10.3 LPI).....	163
Plot, Even Dot (P-Series XQ High Density Graphics).....	164
Plot, Odd Dot (P-Series XQ Normal Density Graphics).....	164
Select Draft Print.....	165
Space.....	165
Underline.....	165
Vertical Tab.....	166

<b>7 Super-Set Programming.....</b>	<b>167</b>
Introduction .....	167
Using the Super-Set Commands .....	167
Character Sets .....	167
Character Set Selection (UTF8) .....	171
Character Spacing <i>n/240</i> Inch .....	171
Font Selection .....	171
TrueType Font Selection.....	175
Line Spacing <i>n/288</i> Inch .....	175
Printer Protocol Select.....	175
Barcodes.....	176
Barcode Format .....	178
Codabar.....	181
Code 39.....	183
Code 93.....	185
Code 128.....	187
EAN 8.....	191
EAN 13.....	192
FIM .....	193
Intelligent Mail 4-State Barcode.....	195
Interleaved 2/5 (I-2/5) and German I-2/5.....	196
MSI .....	197
PDF 417 .....	198
PostBar and Royal Mail.....	199
POSTNET .....	200
Telepen .....	202
UCC/EAN-128.....	203
UPC-A .....	207
UPC-E .....	208
UPC Shipping.....	211
UPS 11 .....	212
<b>8 Graphics .....</b>	<b>214</b>
Overview.....	214
Bit Image Graphics .....	214
Designing a Bit Image Pattern .....	215
Bit Image Density .....	216
Plot Mode.....	218
Plot Density .....	218
Plot Data Byte Format.....	219
Plot Data Line Format .....	220
Plotting the Data.....	222
Exiting from P-Series/P-Series XQ Variant Plot Mode .....	223

Plot Data Byte Dot Patterns.....	224
<b>9 Vertical Page Formatting .....</b>	<b>226</b>
Overview.....	226
Planning a Vertical Page Format.....	226
VFU Characteristics .....	226
Vertical Tab Table for Proprinter, Epson, and Serial Matrix.....	227
Executing Vertical Tabs.....	227
Vertical Tab Positions .....	227
EVFU for P-Series and P-Series XQ Variant Emulations.....	228
Start Load Code - Hex 1E Or 6E.....	228
Channel Assignment.....	228
End Load - Hex 1F or 6F .....	229
Using the EVFU .....	229
Clearing the EVFU Memory.....	231
Relative Line Slewing.....	231
DVFU: Dataproducts Direct Access Vertical Format Unit.....	233
Start Load Code - Hex 6C, 6D, or 6E .....	233
Channel Assignments .....	233
End Load Code - Hex 6F.....	233
Using the DVFU .....	234
Clearing the DVFU Memory.....	234
Relative Line Slewing.....	235
CVFU: Centronics Vertical Format Unit.....	236
Start Load Code - Hex 1D .....	236
Channel Assignments .....	236
End Load Code - Hex 1E .....	236
Using the CVFU - Hex 1F.....	237
Clearing the CVFU Memory.....	238
Relative Line Slewing.....	238
<b>10 Downloading Characters .....</b>	<b>240</b>
Downloading Character (P-Series and Serial Matrix Only) .....	240
Procedure.....	240
Examples.....	243
Downloaded Fonts and Character Sets.....	249
Download a Character Set Overlay .....	250
<b>11 Indian Font Printing .....</b>	<b>254</b>
<b>A ASCII Character Set .....</b>	<b>256</b>
<b>B PTX_SETUP Commands .....</b>	<b>258</b>
Overview.....	258
The PTX_SETUP Commands.....	258

General Commands .....	258
Line Matrix Commands .....	263
<b>C Character Library .....</b>	<b>266</b>
<b>D Glossary.....</b>	<b>272</b>
<b>E Contact Information .....</b>	<b>284</b>
Printronix Customer Support Center.....	284
Printronix Supplies Department .....	284
Corporate Offices .....	285

# 1 *Introduction*

## About this Manual

This manual is designed so that you can quickly find the information you need to program the LinePrinter Plus<sup>®</sup> emulations provided with your printer. The following five LinePrinter Plus emulations (or protocols) are provided as part of the default configuration for your printer:

- IBM<sup>®</sup> Proprinter<sup>®</sup> III XL emulation
- Epson<sup>®</sup> FX-1050 emulation
- Printronix<sup>®</sup> P-Series emulation
- Serial Matrix emulation
- Printronix P-Series XQ Variant emulation

Each emulation may be configured and programmed by sending emulation control codes from an attached host computer to the printer. The control codes for each emulation are described in this book. You may also configure many parameters using the printer's control panel, as described in the *Administrator's Manual*.

Brief descriptions follow for each chapter in this book:

**Chapter 1, Introduction.** Provides an overview of this book, printer features, and line matrix printing technology.

**Chapter 2, IBM Proprinter III XL Emulation.** Describes the Proprinter XL control code commands that you can send to the printer through the host data stream. These commands allow you to send instructions to the printer and configure many Proprinter III XL emulation parameters.

**Chapter 3, Epson FX-1050 Emulation.** Explains the Epson control code commands that you can send to the printer through the host data stream. These commands allow you to send instructions to the printer and configure many Epson FX emulation parameters.

**Chapter 4, P-Series Printer Emulation.** Covers the P-Series control code commands that you can send to the printer through the host data stream. These commands allow you to send instructions to the printer and configure many P-Series emulation parameters.

**Chapter 5, Serial Matrix Printer Emulation.** Describes the Serial Matrix control code commands that you can send to the printer through the host data stream. These commands allow you to send instructions to the printer and configure many Serial Matrix emulation parameters.

**Chapter 6, P-Series XQ Variant Printer Emulation.** Covers the P-Series XQ Variant control code commands that you can send to the printer through the host data stream. These commands allow you to send instructions to the printer and configure many XQ emulation parameters.

**Chapter 7, Super-Set Programming.** Describes the super-set commands that are available to enhance the LinePrinter Plus emulations. The superset commands allow you to select character sets and draw barcodes.

**Chapter 8, Graphics.** Information about bit image graphics printing and programming. Descriptions are provided for designing a bit image pattern, using control codes to set bit image density, and issuing commands for bit image programming. A bit image sample program is included.

**Chapter 9, Vertical Page Formatting.** Information on programming and using vertical format unit (VFU) programs that regulate vertical paper movement and vertical tabs for printing forms.

**Chapter 10, Downloading Characters.** Information on saving, restoring, and deleting downloaded characters and character sets.

## **Warnings And Special Information**

Read and comply with all information highlighted under special headings:

**WARNING**        **Conditions that could harm you as well as damage the equipment.**

**CAUTION**        **Conditions that could damage the printer or related equipment.**

**IMPORTANT**     **Information vital to proper operation of the printer.**

**NOTE:** Information affecting printer operation.

# 2 *IBM Proprinter III XL Emulation*

## Overview

This chapter describes the Proprinter III XL emulation host control codes. “Emulation” refers to the ability of a printer to execute the commands of a particular printer control language. A printer control language is the coding system used to convey, manipulate, and print data. It contains character codes and command sequences that configure the emulation. In this manual, the terms “emulation,” “printer protocol,” and “printer control language” are synonymous.

In the Proprinter III XL emulation mode, your printer can print files coded for the Proprinter III XL printer control language. To select the Proprinter emulation as the active printer emulation, select LinePrinter+ from the EMULATION menu and Proprinter III XL from the Printer Protocol menu, as described in the *Administrator's Manual*.

The Proprinter III XL emulation provides many configurable parameters. The default parameter values for this emulation are shown in Table 1. You can modify these parameter values in two ways:

- **The Proprinter III XL host control codes.** An extensive set of Proprinter III XL control code commands can be sent to the printer from an attached host computer via the host data stream. Most of this chapter is devoted to describing the Proprinter III XL control code commands.
- **The printer configuration menus.** You can modify a subset of the Proprinter III XL emulation parameters using the printer configuration menus, control panel keys, and LCD, as described in the *Administrator's Manual*.

Control codes sent from a host system generally override previous settings that result from the configuration menus.

**NOTE:** Configuration values selected from the menus or via host control codes can be saved to the printer's NVRAM memory so that they will not be lost when you power off the printer or reset it to the factory default configuration. The menu selection for saving a configuration to memory is described in the *Administrator's Manual*. Refer to Appendix B, PTX\_SETUP Commands to save the configuration using host control codes.

## Proprinter III XL Emulation Default Settings

The factory settings for the Proprinter III XL emulation menu options are shown in Table 1. Table 2 lists additional factory settings for parameters provided by the LinePrinter+ formatting menus. (The EMULATION menu options are described in the *Administrator's Manual*). Host control codes can override many of the settings for these menu options.

**Table 1 Proprinter III XL Menu Option Factory Setting**

<b>Characteristic</b>	<b>Default Setting</b>
Define CR Code	CR = CR
Auto LF	Enable
Define LF Code	LF = LF
FF Valid at TOF	Enable
Character Set	Code Page 437
Alt. Char Set	Set 1
20 CPI Condensed	Enable

**Table 2 LinePrinter+ Menu Option Factory Settings**

<b>Characteristic</b>	<b>Default Setting</b>
CPI	10.0
LPI	6.0
Host Command	Enable
Typeface	Data Processing
Proportional Spacing	Disable
Bold Print	Disable
Italic Print	Disable
Slashed Zero	Disable
Text Position	Top of Line
Left Margin	0 columns
Right Margin	0 columns
Bottom Margin	0 lines
Perforation Skip	Disable
Form Length	11.0 inches 279.4 millimeters 66 lines
Form Width	13.6 inches 345.4 millimeters 136 characters
Reset Cmd CFG Ld	Disable



# Configuring the Proprinter III XL Emulation with Control Codes

The remainder of this chapter describes the Proprinter printer control language codes that may be sent from a host computer attached to the printer, in order to configure numerous Proprinter III XL emulation parameters.

## Format for Control Code Descriptions

In this chapter, the following information is listed for each control code (where applicable):

<b>Name</b>	The title or function of the command.
<b>ASCII Code</b>	The ASCII mnemonic for the command is shown. Command sequences are in 7-bit (ASCII) form.
<b>Hex Code</b>	The code or command sequence in hexadecimal numbers.
<b>Dec Code</b>	The code or command sequence in decimal numbers.
<b>Purpose</b>	The function(s) of the control code.
<b>Discussion</b>	A discussion of the uses of the code or command sequence, including exceptions or limitations to its use.
<b>Example</b>	A sample is provided when it is possible to illustrate the effect of a control code or if a specific syntax is required.

**NOTE:** If you specify any parameters for a control code other than the ones that are defined in the control code description, unpredictable results may occur. The PI line is never recognized in Proprinter III XL Emulation mode.

## Escape Control Codes Overview

Printer capability is greatly increased by the use of escape control code sequences. Escape sequences always begin with the ASCII escape sequence introducer, ESC (hex 1B). Many of the ASCII control codes described in this chapter are escape sequences.

**IMPORTANT** An Escape code can occur anywhere in the datastream and is acted upon immediately if it precedes a valid command.

An ESC sequence introducer in the data stream signals the printer to wait for special instructions, even if it is ready and printing. The character codes following the ESC character tell the printer what to do.

**NOTE:** For readability, code sequences appear in this manual with spaces inserted between command elements. Do not insert spaces between code characters when you are programming unless the ASCII space character (SP) is part of a code sequence. For example, a code sequence printed in this manual as ESC [ 1 is programmed as ESC[1.

An escape sequence uses two or more bytes to define a specific printer control function. The format for an escape sequence is:

<b>ASCII</b>	ESC	X	<i>n</i>
<b>Hex</b>	1B	00-7F	0-FF
	Escape Sequence Introducer	Character(s)	Numerical parameter(s)

After the ESC character are one or more characters which indicate the action of the control code. One or more numerical parameters may in turn follow these characters. For example, the sequence ESC S *n* tells the printer to begin the superscript print attribute if *n* is an even number, or to begin the subscript attribute if *n* is an odd number.

If the characters following the ESC code are not within the defined ranges, or if they are within the defined ranges but not recognized as a function of this printer, the entire sequence is ignored.

## Graphics Control Codes Overview

The individual control codes that set graphics print quality are described starting on page 19. Some additional background information about graphics printing for the Proprinter III XL emulation is provided here.

The Proprinter III XL emulation provides one data protocol for printing graphics information; the Bit Image graphics protocol allows an image block to be printed. When using the Bit Image protocol, you can mix text and graphics on the same line.

### Setting Bit Image Modes via Control Codes

Control codes select bit image modes. The following bit image modes can be mixed on the same line as text characters:

**Table 3 Bit Image Modes**

Control Code	Bit Image Mode
ESC K <i>n1 n2 data</i>	Normal Density
ESC L <i>n1 n2 data</i>	Double Density
ESC Y <i>n1 n2 data</i>	Double Density, Double Speed
ESC Z <i>n1 n2 data</i>	Quadruple Density

Parameters *n1* and *n2* together represent a 16-bit (hexadecimal) unsigned number of the quantity ( $n1 + 256n2$ ), which equals the number of bit image characters (i.e. data bytes) to follow. If *n1* and *n2* are programmed so that data extends past the last character position, the data is truncated at the last character position. If *n1* and *n2* are both zero, the ESC sequence is ignored.

See Chapter 8 for details on bit image graphics.

### Dot Density versus Printing Speed

When you select ESC K (normal density), the dot columns are printed at 60 dots per inch (dpi) horizontally and 72 dpi vertically. This does not decrease printing speed.

If ESC L (double density) is selected, the dot columns are printed at 120 dpi horizontally and 72 dpi vertically. Double density reduces printing speed by one half.

With ESC Y (double density, double speed), dot columns are printed at 120 dpi horizontally and 72 dpi vertically, but adjacent dots are not printed. Double density, double speed does not decrease printing speed.

When ESC Z (quadruple density) is selected, the dot columns are printed at 240 dpi horizontally and 72 dpi vertically. Quadruple density reduces printing speed by one half.

All line-by-line character print attributes are ignored in Bit Image graphics. The most significant bit for each data character is the uppermost dot position in the vertical dot image pattern. A bit value of 1 indicates a dot; a value of 0 indicates a blank. In 7-bit RS-232E serial interface protocol, the most significant bit (bit 8) is cleared to 0.

## Code Page and Character Set Control Codes

A code page is a set of symbols consisting of letters, numbers, and graphic elements. For the Proprinter III XL emulation, your printer supports characters from IBM's Code Page 0437 and Code Page 0850, among an extensive array of different print quality and print language sets. The print language sets are selected using the Print Language configuration menu option, which is described in detail in your *Administrator's Manual*.

Two columns of characters, hex 80 through 9F, may be configured as either control codes or printable symbols. Control code ESC 7 selects Character Set 1 (hex 80-9F configured as control codes). Control code ESC 6 selects Character Set 2 (hex 80-9F configured as printable symbols).

## Ignored Codes

The control codes recognized by the Proprinter III XL emulation software are described in this chapter. Control codes not described in this chapter are undefined and ignored. In addition, codes that represent printable characters (hex 10, 11, 15, 21-7E, and 80-FF) are not available as Proprinter III XL control codes.

**NOTE:** Entering control codes that are not defined in this chapter may produce unpredictable results.

The ASCII control code ETX (hex code 03 or 1B 03) is ignored as a Proprinter III XL control code, but is valid for the Serial Interface Protocol.

## Reserved Codes

The Download Characters control code (ASCII code ESC =, hex code 1B 3D) is a reserved code. It is not implemented at this time. When implemented, this code is usually followed by large blocks of data. The Proprinter III XL emulation will currently ignore this control code and any data applicable to it.

## The Control Codes

This index lists each printer command by function, ASCII mnemonic, and the page where the command is explained in detail. "N/A" means not applicable. The rest of this chapter defines the control code functions for Proprinter III XL emulation mode. The commands are listed in alphabetical order.

† = Produces non-Printer behavior in your printer.

<b>FUNCTION</b>	<b>ASCII CODE</b>	<b>PAGE</b>
<b>Paper Motion</b>		
Form Feed	FF	30
Line Feed	LF	33
Line Feed <i>n</i> /216" (One Line Only)	ESC J <i>n</i>	33
Tab, Vertical	VT	44
Tab Set/Clear, Vertical	ESC B <i>n1 n2 ... nk</i> NUL	44
Tabs, Clear All (Return to default)	ESC R	45
<b>Format</b>		
† Backspace	BS	22
Cancel	CAN	25
Carriage Return	CR	25
Carriage Return Set	ESC 5 <i>n</i>	25
Forms Length Set in Inches	ESC C NUL <i>n</i>	30
Forms Length Set in Lines	ESC C <i>n</i>	31
Margin, Bottom	ESC N <i>n</i>	36
Margin, Bottom (Cancel)	ESC O	37
Margins, Horizontal	ESC X <i>n m</i>	37
Set Top-of-Form	ESC 4	42
Tab, Horizontal	HT	43
Tab Set/Clear, Horizontal	ESC D <i>n1 n2 nk</i> NUL	43
Tabs, Clear All (Return to default)	ESC R	45
<b>Line Spacing</b>		
Line Spacing 1/8 Inch (8 lpi)	ESC 0	34
Line Spacing 7/72 Inch (10.3 lpi)	ESC 1	34
Line Spacing <i>n</i> /72 Inch (Executes)	ESC 2	35
Line Spacing <i>n</i> /72 Inch (Storage)	ESC A <i>n</i>	35
Line Spacing <i>n</i> /216 Inch	ESC 3 <i>n</i>	36
<b>Selection of Character Set</b>		
Character Set Select: Set 1 (A)	ESC 7	26
Character Set Select: Set 2 (B)	ESC 6	26
<b>Print Quality</b>		
† Bold Printing	ESC G	24
Bold Printing, Cancel	ESC H	24
† Character Pitch 12 cpi	ESC :	26
† Condensed Print	SI	26
Condensed Print Cancel	DC2	27
† Double Wide Print	ESC W <i>n</i>	28
† Double Wide Print (One Line Only)	SO	29
Double Wide Print (One Line Only) Cancel	DC4	29
† Emphasized Print	ESC E	29
Emphasized Print Cancel	ESC F	30
† Overscoring	ESC _ <i>n</i>	37
† Print Mode	ESC I <i>n</i>	38
† Print Quality	ESC x <i>n</i>	39
† Proportional Spacing	ESC P <i>n</i>	40
† Select Attributes	ESC [ @ <i>n1</i> NUL NUL NUL <i>n2 n3</i>	40

<b>FUNCTION</b>	<b>ASCII CODE</b>	<b>PAGE</b>
† Superscript/Subscript Printing	ESC S <i>n</i>	41
Superscript/Subscript Printing, Cancel	ESC T	42
† Underline	ESC – <i>n</i>	45
<b>Bit Image</b>		
Bit Image, Single Density (Normal Speed)	ESC K <i>n1 n2</i>	22
Bit Image, Double Density (Half Speed)	ESC L <i>n1 n2</i>	23
Bit Image, Double Density, (Normal Speed)	ESC Y <i>n1 n2</i>	23
Bit Image, Quadruple Density, (Half Speed)	ESC Z <i>n1 n2</i>	23
<b>Other Functions</b>		
Bell	BEL	22
Deselect Printer	ESC Q 22	27
Escape Sequence	ESC	17
Initialize Parameters	ESC [ K <i>n1</i> NUL <i>n2 n3 n4 n5</i>	31
Print All Characters	ESC \ <i>n1 n2</i>	38
Print Next Character	ESC ^ <i>n</i>	38
Super-Set Commands	ESC   } ;	42
Unidirectional Printing	ESC U <i>n</i>	45

## Backspace

**ASCII** BS

**Hex** 08

**Dec** 08

**Purpose** Moves the logical print head to the left one character space toward the first character column.

**Discussion** BS moves the character position indicator (the logical print head position) one character space to the left at the current character pitch setting. This code is ignored if the logical print head is positioned at the first character column.

When the backspace code is received, printing speed will be reduced. If the printer is in double width mode, the backspace code moves the print head left two normal character spaces.

**Example** If you were to print five "T" characters, then two BS commands, then two "=" characters, the output would look like the sample below:

```
TTTT=
```

## Bell

**ASCII** BEL

**Hex** 07

**Dec** 07

**Purpose** Sounds a buzzer/beeper.

**Discussion** The BEL function will sound the buzzer/beeper for 0.2 seconds upon receipt of this command.

## Bit Image Mode, Single Density (Normal Speed)

**ASCII** ESC K *n1 n2*

**Hex** 1B 4B *n1 n2*

**Dec** 27 75 *n1 n2*

**Purpose** Selects single (normal) density bit image graphics.

**where:** *n1 + 256n2* defines the number of data bytes to follow.

DATA = ASCII characters for the dot pattern bytes.

**Discussion** This code prints specified data as bit image graphics at normal density, 60 dots per inch horizontally and 72 dots per inch vertically. For more information, see Graphics Control Codes Overview on page 18 and Bit Image Graphics on page 214.

**Example** The following example produces a pattern of Single Density Bit Image graphics. The 9-byte bit pattern is repeated 27 times. Compare this example to the double density and quadruple density examples.

```
Single Density Bit Image Graphics
NNNNNNNNNNNNNNNNNNNNNNNNNNNNNNNN
```







## Cancel

**ASCII** CAN

**Hex** 18

**Dec** 24

**Purpose** Clears the print buffer of all symbols since the last paper motion command was received.

**Discussion** The CAN command cancels all characters sent to the printer after the last paper motion command.

This command will cancel the double wide attribute if set by SO. No other print attributes are affected.

## Carriage Return

**ASCII** CR

**Hex** 0D

**Dec** 13

**Purpose** Returns the logical print head to the first character column (resets the pointer to the first character position). May be configured to include a line feed.

**Discussion** The CR code is configured via the ESC 5 code or via the operator panel menus (described in the *Administrator's Manual*). The CR = CR configuration causes the character position indicator to be positioned at character column one; subsequent printable data preceding a paper motion command overstrikes previously printed data. The CR = CR + LF configuration causes the CR code to perform a carriage return plus a line feed.

The CR code also cancels expanded (double wide) print when set by code SO (single line printing attribute).

## Carriage Return Set

**ASCII** ESC 5 *n*

**Hex** 1B 35 *n*

**Dec** 27 53 *n*

**Purpose** Defines the result from the Carriage Return (CR) code.

**where:** *n* may range from 0 through 255

If *n* = 0, 2, 4 ... (any even value), then CR = CR (the default).

If *n* = 1, 3, 5 ... (any odd value), then CR = CR + LF.

**Discussion** This command overrides the configuration menu setting.

- CR = CR (default) configuration causes the character position indicator to be positioned at character column one. Subsequent printable data preceding a paper motion command overstrikes previous printable data.
- CR = CR + LF configuration causes the CR code to perform a carriage return plus a line feed.

## Character Pitch 12 cpi

<b>ASCII</b>	ESC :
<b>Hex</b>	1B 3A
<b>Dec</b>	27 58
<b>Purpose</b>	Sets character pitch to 12 cpi.
<b>Discussion</b>	An ESC: code overrides any operator panel setting.

## Character Set Select: Set 1 (A)

<b>ASCII</b>	ESC 7
<b>Hex</b>	1B 37
<b>Dec</b>	27 55
<b>Purpose</b>	Selects hex codes 80 through 9F in the character sets as control codes. Cancels the command ESC 6.
<b>Discussion</b>	This control code overrides the operator panel setting (described in the <i>Administrator's Manual</i> ).

## Character Set Select: Set 2 (B)

<b>ASCII</b>	ESC 6
<b>Hex</b>	1B 36
<b>Dec</b>	27 54
<b>Purpose</b>	Selects hex codes 80 through 9F in the character sets as printable symbols. Cancels the command ESC 7.
<b>Discussion</b>	This control code overrides the operator panel setting.

## Condensed Print

<b>ASCII</b>	SI	ESC SI
<b>Hex</b>	0F	1B 0F
<b>Dec</b>	15	27 15
<b>Purpose</b>	Sets condensed print.	
<b>Discussion</b>	You may enable or disable the condensed print feature using the operator panel (the default setting for the Condensed Print option is enabled). Once condensed print is enabled, this control code sets condensed print until it is canceled by control code DC2, a printer reset, or a new print mode (ESC I) control code.  The manner in which the print is condensed varies depending on the initial print size. Several examples are listed in Table 4:	

**Table 4 Condensed Print**

Initial Print Size	Condenses To
5 cpi	8.55 cpi
6 cpi	10 cpi
8.58 cpi	no change
10 cpi	17.16 cpi
12 cpi (except NLQ)	20 cpi
† 12 cpi NLQ	17.16 cpi
17.16 cpi	no change
20 cpi	no change

**Example** The following sample shows condensed character printing and reset.

```
Control code
SI selects
condensed character printing.
Control code DC2
resets condensed character printing.
```

### Condensed Print Cancel

**ASCII** DC2 ESC DC2

**Hex** 12 1B 12

**Dec** 18 27 18

**Purpose** Cancels condensed character printing and sets pitch to 10 cpi.

**Discussion** The Condensed Print Cancel command sets the character pitch to 10 cpi, or 5 cpi if printing is set for double wide.

**Example** See the SI control code (page 26) for an example of Condensed Print Cancel.

### Deselect Printer

**ASCII** ESC Q 22

**Hex** 1B 51 16

**Dec** 27 81 22

**Purpose** Stops the printer from processing data received from the host computer.

**Discussion** This code is for diagnostic use; it instructs the printer to stop processing data received from the host system. In order to resume processing data, the printer must be reset from the host system.

**Example** Using the BASIC language, you may deselect the Proprinter III XL with the following:

```
LPRINT CHR$( 27 ) ; CHR$( 81 ) ; CHR$( 22 ) ;
```

## Double Wide Print

**ASCII** ESC W *n*

**Hex** 1B 57 *n*

**Dec** 27 87 *n*

**Purpose** Selects or cancels double wide (expanded) print.

**where:** *n* may range from 0 through 255

If *n* = 1, 3, 5 ... (any odd value), double wide print is selected.

If *n* = 0, 2, 4 ... (any even value), double wide print is cancelled.

**Discussion** An ESC W code sets or cancels double wide print, as follows:

When expanded print using ESC W is received, all characters print double wide until cancelled by an even parameter hex code.

Double wide print can also be set via the command SO and ESC SO, double wide print for one line only. An ESC W code overrides these settings.

The manner in which the print is expanded varies depending on the initial print size. Several examples are listed in Table 5:

**Table 5 Double-Wide Print**

Initial Print Size	Expands To
5 cpi	no change
6 cpi	no change
8.58 cpi	no change
10 cpi	5 cpi
12 cpi	6 cpi
17.16 cpi	8.55 cpi
20 cpi	10 cpi

**Example** The following sample illustrates expanded character printing and expanded character printing reset.

```
Control code
ESC W 1 selects
expanded character print:
Control code
ESC W 0 resets
expanded character printing.
```

## Double Wide Print (One Line Only)

**ASCII** SO ESC SO

**Hex** 0E 1B 0E

**Dec** 14 27 14

**Purpose** Selects double wide print for one line only.

**Discussion** This expanded print command is a line-by-line print attribute; when the SO or ESC SO command is received, the current line will be printed double wide and automatically reset. This command can be reset by a paper motion command (FF, LF, VT, CR), by the DC4 (double wide cancel) code, CAN or ESC W (double wide print).

See the previous control code (ESC W) for examples of print expansion for various initial print sizes.

**Example** The following sample illustrates Expanded Print for one line only.

```
Control code
SO selects
expanded character printing
for one line only.
```

## Double Wide Print (One Line Only) Cancel

**ASCII** DC4 ESC DC4

**Hex** 14 1B 14

**Dec** 20 27 20

**Purpose** Cancels double wide print, if it was set by command SO.

**Discussion** The DC4 code cancels Double Wide Print command SO. If Double Wide Print is not enabled, the DC4 code is ignored. A DC4 code can occur at any place in the datastream and is acted upon immediately.

## Emphasized Print

**ASCII** ESC E

**Hex** 1B 45

**Dec** 27 69

**Purpose** Selects emphasized character print format.

**Discussion** When the emphasized print command is received, all characters will be printed in emphasized (bold) print until reset by the Emphasized Print Reset command or printer reset. Emphasized print reduces the current print speed.

**NOTE:** The ESC G (page 24) and ESC E commands are equivalent; they produce the same print effect.

**Example** The following sample illustrates emphasized character printing.

```
Control code
ESC E selects
emphasized character printing.
Control code ESC F
cancels emphasized character printing.
```

## Emphasized Print Cancel

<b>ASCII</b>	ESC F
<b>Hex</b>	1B 46
<b>Dec</b>	27 70
<b>Purpose</b>	Cancels emphasized character printing.
<b>Discussion</b>	The emphasized print reset command only resets the emphasized print character attribute. See Example above for using ESC E combined with ESC F.

## Form Feed

<b>ASCII</b>	FF
<b>Hex</b>	0C
<b>Dec</b>	12
<b>Purpose</b>	Prints the data in the buffer, advances the paper to the next top- of-form, and moves the logical printhead to the first character column.
<b>Discussion</b>	Forms length is set by using the operator panel or forms length control codes. This code cancels double wide (expanded) characters if set by the SO command.  The Form Feed command will react differently when the VFU is active. Refer to Chapter 9 for further information.

## Forms Length Set in Inches

<b>ASCII</b>	ESC C NUL <i>n</i>
<b>Hex</b>	1B 43 00 <i>n</i>
<b>Dec</b>	27 67 0 <i>n</i>
<b>Purpose</b>	Sets the length of forms (paper) in inches.
<b>where:</b>	<i>n</i> = whole numbers from 1 through 24 to specify the number of inches on a page. (All larger values are ignored.)
<b>Discussion</b>	Upon receipt of this code, the current line becomes the first line of the form, and the forms length set becomes the current forms length. Vertical tab positions set below the bottom of the form are ignored; in addition, once a new forms length is set the bottom margin is set to zero.  Line spacing changes do not affect the result of this command. If the forms length is set smaller than the line spacing, a form feed advances the paper position to the next top-of-form position.  Forms length in inches can also be set at the operator panel via the Print Format menu. However, this host control code overrides the operator panel setting.

## Forms Length Set in Lines

**ASCII** ESC C *n*

**Hex** 1B 43 *n*

**Dec** 27 67 *n*

**Purpose** Sets the length of a form (paper) in lines.

**where:** *n* = 1 through 192 (1 through C0 hex) to specify the number of lines per page at the current line spacing.

**Discussion** The forms length is defined in inches as the quotient of *n* divided by the current lines per inch (lpi) setting. Once the forms length has been set, subsequent line spacing changes do not affect the result of this command.

If the forms length is set smaller than the line spacing, a form feed advances the paper position to the next top-of-form.

If the forms length derived from the quotient of *n* lines divided by lines per inch is not an exact multiple of the printer dot resolution, the value is adjusted down until the forms length and dot resolution distance match.

Forms length in lines can also be set at the operator panel via the Print Format menu. However, this host control code overrides the operator panel setting.

## Initialize Parameters

**ASCII** ESC [ K *n1* NUL *n2 n3 n4 n5*

**Hex** 1B 5B 4B *n1* 00 *n2 n3 n4 n5*

**Dec** 27 91 75 *n1* 0 *n2 n3 n4 n5*

**Purpose** Sets the printer initial condition.

**Discussion** This command causes the printer to reset and defines the configuration that will be loaded to the printer during the reset. Several variables must be specified to define the load configuration, as described below.

**NOTE:** An ESC[K code can occur at any place in the datastream and is acted upon immediately. All numerical parameters are in the hex 00 through FF range unless stated otherwise. Only specified parameters are supported. Other values may be ignored or cause unpredictable results, and should be avoided.

*n1* The value of *n1* defines which of the following *n* bytes will be included in the command line, as shown in Table 6.

**Table 6 Defining Bytes in the Command Line**

<i>n1</i> Hex Value	Function
1	One byte follows ( <i>n2</i> )
3	Three bytes follow ( <i>n2</i> , <i>n3</i> , and <i>n4</i> )
4	Four bytes follow ( <i>n2</i> , <i>n3</i> , <i>n4</i> , and <i>n5</i> )

**IMPORTANT** Specifying any value for *n1* other than 1, 3, or 4 may cause unpredictable results, and should be avoided.

*n2* The 2-digit hexadecimal value for *n2* defines the load configuration for the printer. The Proprinter III XL supports six hexadecimal values for this parameter: 00, 01, 04, 05, 254, and 255. Table 7 describes the different load configurations that will result with each value:

**Table 7 Load-up Configuration**

<i>n2</i> Hex Value	Function
00, 01, 254	The printer will load the power-up configuration that is stored in memory. Configuration changes that are defined by command bytes <i>n4</i> and <i>n5</i> , if present, will override conflicting values stored in memory.
04, 05, 255	The printer will load the factory default configuration. Configuration parameters defined by command bytes <i>n4</i> and <i>n5</i> , if present, will override conflicting factory default values.

*n3* Parameter *n3* is provided for compatibility with the Proprinter III XL printer control language standard. You may define any value for this parameter. (For Proprinters, this bit must define the attached printer as either Proprinter III, hex value 03, or Proprinter III XL, hex value 16.)

*n4* and *n5* Parameter bytes *n4* and *n5* allow you to define several configuration parameters that will override conflicting factory default and NVRAM-based configuration values when the printer is reinitialized. Depending on the value that is defined for *n2* (refer to Table 7), these values may also be saved to memory.

**NOTE:** In addition to the formatting from bytes *n4* and *n5*, this command sets the current line as top-of-form. It also clears vertical tabs and sets the horizontal tabs at every eight columns, starting at column 9.

**Table 8 Configuration Parameters (*n4*)**

<i>n4</i> Bit	Function	OFF (0)	ON (1)
7	Process this byte.	Process	Ignore
6	Reserved	Reserved	Reserved
5	N/A	-----	-----
4	Line Feed =	LF	LF + CR (add CR with each LF)
3	Carriage Return =	CR	CR + LF (add LF with each CR)
2	Set forms length	11"	12"
1	Slashed zero	Disable	Enable
0	Character set	1 (A)	2 (B)



**Table 9 Configuration Parameters (n5)**

<i>n5</i> Bit	Function	OFF (0)	ON (1)
7	Process this byte.	Process	Ignore
6	Code page	437	850
5	Unidirectional printing	bidirectional	unidirectional
4	12 cpi compressed to 20	20	12
3	n/a	---	---
2	Form feed at TOF	Enable	Ignore
1	Print width	13.6 inch	8 inch
0	Sheet feeder	N/A	N/A

### Line Feed

**ASCII** LF

**Hex** 0A

**Dec** 10

**Purpose** Prints the data in the buffer (if any) and advances the paper one line at the current line space setting.

**Discussion** If configured for LF equals new line (LF = CR + LF), the logical print head is positioned at character column 1 of the new line. Otherwise, the logical print head does not move when configured for LF function only (LF = LF only). The LF function cancels double wide (expanded) characters if set by the SO command.

Line feed can occur at any place in the datastream and is acted upon immediately.

### Line Feed *n*/216 Inch (One Line Only)

**ASCII** ESC J *n*

**Hex** 1B 4A *n*

**Dec** 27 74 *n*

**Purpose** Advances the vertical character position *n*/216 inch for one line only.

**where:** *n* = 1 through 255

**Discussion** The *n*/216-inch line feed control code is effective for one line only. All single-line-only print attributes are canceled.

If the emulation is configured for LF equals newline (LF=CR+LF), the paper advances one line at the current line space setting and the logical print head is positioned at character column 1.

The paper position moves only in multiples of the current dot row spacing. If the distance to move is other than a multiple of the current dot row spacing, the remainder is added to the next paper motion command.

Small values of  $n$  may result in overlapping lines. Overlapping lines may also occur if print attributes such as Elongated (Double High), Superscript, or Subscript characters are used on the same line. Printing at different horizontal and vertical densities will not overlap.

**Example** The following example illustrates  $n/216$ -inch line spacing.

```
Control code ESC J 200
```

```
performs a 200/216 inch  
line feed function for one line only.
```

### Line Spacing 1/8 Inch (8 lpi)

**ASCII** ESC 0

**Hex** 1B 30

**Dec** 27 48

**Purpose** Specifies continuous line spacing at 1/8-inch increments (8 lpi).

**Discussion** When the 1/8-inch line spacing control code is received, all lines will be printed at 8 lpi until a new line spacing is selected or the printer is reset.

**Example** The following example illustrates 1/8-inch line spacing.

```
Control code ESC 0 sets  
line spacing at  
1/8 (8 lpi) inch for all subsequent lines  
until reset or another spacing is selected.
```

### Line Spacing 7/72 Inch (10.3 lpi)

**ASCII** ESC 1

**Hex** 1B 31

**Dec** 27 49

**Purpose** Specifies the line spacing at 7/72-inch (10.3 lpi) increments.

**Discussion** When the 7/72-inch line spacing control code is received, all lines will be printed at the 7/72-inch line spacing until a new line spacing is selected or the printer is reset. The control code line spacing selection will override the operator panel line spacing setting, and the message display will reflect the line spacing as lines per inch.

Caution should be used when combining this control code with other print attributes such as Elongated (Double High), Superscript, or Subscript; overlapping lines may occur.

**Example** The following example illustrates 7/72-inch line spacing.

```
Control code ESC 1 sets  
line spacing at  
7/72 inch for all subsequent lines  
until reset or another spacing is selected.
```

### Line Spacing $n/72$ Inch (Executes)

**ASCII** ESC 2

**Hex** 1B 32

**Dec** 27 50

**Purpose** ESC 2 sets line spacing to 6 lpi or as set by ESC A.

**Discussion** ESC 2 asserts  $n/72$ -inch line spacing as set by ESC A (page 35). If no distance has been set by ESC A, the distance is 1/6 inch.

The control code line spacing selection will override the operator panel line spacing setting.

**Example** The following example illustrates 1/6-inch line spacing and assumes that a distance has not been set by ESC A.

```
Control code ESC 2 sets  
line spacing at  
6 lpi for all subsequent lines  
until reset or another spacing is selected.
```

### Line Spacing $n/72$ Inch (Storage)

**ASCII** ESC A  $n$

**Hex** 1B 41  $n$

**Dec** 27 65  $n$

**Purpose** Stores a line spacing of  $n/72$ -inch increments.

**where:**  $n = 1$  through 255 (all others are ignored)

**Discussion** This control code stores a value for line spacing of  $n/72$  inch. The ESC 2 control code (described on page 35) executes the line spacing stored by the preceding ESC A, until a new line spacing is selected or power to the printer is reset. A control code line spacing overrides an operator panel line spacing setting. (The operator panel display shows line spacing in lines per inch.)

Small values of  $n$  may result in overlapping lines. Overlapping lines may also occur if print attributes such as Elongated (Double High), Superscript, or Subscript characters are used on the same line. Common values of  $n$  are shown in Table 10.

**Table 10 Line Spacing ( $n/72$  inch)**

$n$	Line Spacing
24	3 lpi
18	4 lpi
12	6 lpi
9	8 lpi
8	9 lpi
6	12 lpi

**Example** The following example illustrates 20/72-inch line spacing.

```
Control code ESC A 20 sets  
line spacing at 20/72 inch  
  
increments for all subsequent lines  
  
until reset or another spacing is selected.
```

### Line Spacing $n/216$ Inch

**ASCII** ESC 3  $n$

**Hex** 1B 33  $n$

**Dec** 27 51  $n$

**Purpose** Specifies the line spacing at  $n/216$ -inch increments.

**where:**  $n = 1$  through 255

**Discussion** When the  $n/216$ -inch line spacing control code is received, all line feeds following will be at  $n/216$ -inch line spacing until a new line spacing is selected or the printer is reset. The control code line spacing selection will override the control panel line spacing setting.

The vertical character position moves only in multiples of the current dot row spacing. If the distance to move is other than a multiple of the current dot row spacing, the remainder is added to the next paper motion command.

Caution should be used when combining this control code with other print attributes such as Elongated (Double High), Superscript, or Subscript; overlapping lines may occur.

**Example** The following example illustrates  $n/216$ -inch line spacing.

```
Control code ESC 3 50 sets  
line spacing at 50/216 inch  
  
increments for all subsequent lines  
  
until reset or another spacing is selected.
```

### Margin, Bottom

**ASCII** ESC N  $n$

**Hex** 1B 4E  $n$

**Dec** 27 78  $n$

**Purpose** Sets the bottom margin.

**Discussion**  $n$  defines the number of lines above the bottom of the form to set as the bottom margin.  $n$  has a range from 1 through 255. The actual margin in inches is the quotient of  $n$  divided by the current lines per inch (lpi).

If a line feed command causes the active position to advance below the bottom margin, the paper advances to the top of the next form. If the bottom margin is set equal to or greater than the form length, printing is only allowed on the top line of each page. If the forms length is changed by the ESC C code (Forms Length sequence), the bottom margin is set to zero.

The bottom margin setting can also be selected from the operator panel; however, the host control code will override the operator panel setting. Any vertical tabs set within the bottom margin zone will be ignored.

## Margin, Bottom (Cancel)

<b>ASCII</b>	ESC O
<b>Hex</b>	1B 4F
<b>Dec</b>	27 79
<b>Purpose</b>	Resets the bottom margin to zero.

## Margins, Horizontal

<b>ASCII</b>	ESC X <i>n m</i>
<b>Hex</b>	1B 58 <i>n m</i>
<b>Dec</b>	27 88 <i>n m</i>
<b>Purpose</b>	Sets left and right margins in character positions.

**where:**  $n$  = left margin position  
 $m$  = right margin position

**Discussion** The values of  $n$  and  $m$  must be in the range from 0 through 255. The margins are measured in character positions at the current characters per inch (cpi).

The value set for  $n$  is the left margin, where  $n$  is the number of character positions from the left edge of the paper. The left margin in inches is the quotient of the value for  $n$  divided by the current cpi. Once the left margin is set, later changes in the cpi do not affect the margin setting.

The value set for  $m$  is the right margin, where  $m$  is the number of character positions from the left edge of the paper. The right margin in inches is the quotient of the value for  $m$  divided by the current cpi. Once the right margin is set, later changes in the cpi do not affect the margin setting.

## Overscoring

<b>ASCII</b>	ESC _ <i>n</i>
<b>Hex</b>	1B 5F <i>n</i>
<b>Dec</b>	27 95 <i>n</i>
<b>Purpose</b>	Enables or disables automatic overscoring of all characters.

**where:**  $n$  may range from 0 through 255

$n = 00, 02, 04$  (any even value) disables automatic overscoring

$n = 01, 03, 05$  (any odd value) enables automatic overscoring

**Discussion** When automatic overscore is enabled, all characters, including spaces, are overscored. Full-height graphics characters are not overscored. (Full-height characters are in the upper ASCII character set for code pages 437 and 850, in positions 176-233, or 244.)

**Example** The following sample illustrates automatic overscoring and overscoring reset.

```
Control code ESC _ 1
enables automatic overscoring.
Control code ESC _ 0
disables automatic overscoring.
```

### Print All Characters

**ASCII** ESC \  $n1\ n2$

**Hex** 1B 5C  $n1\ n2$

**Dec** 27 92  $n1\ n2$

**Purpose** Prints the characters assigned to code points as characters, rather than interpreting the code values as commands.

**where:**  $n1 + 256n2$  defines the number of data bytes to follow.

**Discussion** The number of data bytes specified by  $n1 + 256n2$  will print as text. Valid numerical parameters are in the range hex 00 through hex FF. Data values that do not correspond to standard ASCII codes will print as spaces.

### Print Next Character

**ASCII** ESC ^  $n$

**Hex** 1B 5E  $n$

**Dec** 27 94  $n$

**Purpose** Prints the graphic character assigned to  $n$ , rather than interpreting the code value as a command.

**Discussion** This command may appear anywhere in the data stream, and will be acted upon immediately. Valid numerical parameters are in the range hex 00 through hex FF.

### Print Mode

**ASCII** ESC |  $n$

**Hex** 1B 49  $n$

**Dec** 27 73  $n$

**Purpose** Selects a print mode.

**Discussion** This control code selects a print mode from among the choices in Table 11.

**Table 11 Print Mode**

<i>n</i> (Hex)	Function
0	DP
1	Draft 12 CPI
2	NLQ Sans Serif
3	NLQ Serif
4	DP
5	Draft 12 CPI
6	NLQ Sans Serif
7	NLQ Serif
8	NLQ Serif-Italic-Proportional
9	NLQ Serif-Italic

There are several duplicate Hex values that select the same print quality. These are provided for compatibility with the Proprinter III XL standard.

**IMPORTANT** If you specify any value other than those shown in Table 11, unpredictable results may occur.

### Print Quality

**ASCII** ESC x *n*

**Hex** 1B 78 *n*

**Dec** 27 120 *n*

**Purpose** This code selects a print quality.

**where:**

- n* = hex 0 or hex 30 selects DP print quality
- n* = hex 1 or hex 31 selects NLQ Serif print quality
- n* = hex 2 or hex 32 selects Draft print quality
- n* = hex 3 or hex 33 selects OCR A print quality
- n* = hex 4 or hex 34 selects OCR B print quality

**Comment** Print qualities selected with this command override operator panel selections. Selecting an OCR print quality overrides any character attributes already set, such as condensed, double-wide, etc., and forces 10 cpi. Character attributes set when OCR is selected will be ignored.

**NOTE:** Some print attributes (such as condensed, double-wide, etc.) may not return to their previous setting when changing from OCR-A or OCR-B back to another Print Quality. For guaranteed results, all print attributes should be set after the Print Quality is selected.

## Proportional Spacing

<b>ASCII</b>	ESC P <i>n</i>
<b>Hex</b>	1B 50 <i>n</i>
<b>Dec</b>	27 80 <i>n</i>
<b>Purpose</b>	Enables/disables proportional spacing of characters.
<b>where:</b>	<i>n</i> may range from 0 through 255 <i>n</i> = 1, 3, 5...(any odd value) enables proportional spacing <i>n</i> = 0, 2, 4...(any even value) disables proportional spacing
<b>Comment</b>	This command is ignored when a non-proportional font is used.

## Select Attributes

<b>ASCII</b>	ESC [ @ <i>n1</i> NUL NUL NUL <i>n2</i> <i>n3</i>
<b>Hex</b>	1B 5B 40 <i>n1</i> 00 00 00 <i>n2</i> <i>n3</i>
<b>Dec</b>	27 91 64 <i>n1</i> 0 0 0 <i>n2</i> <i>n3</i>
<b>Purpose</b>	Selects double high and double wide attributes, and single or double high line spacing.
<b>Discussion</b>	Parameter <i>n1</i> selects the attributes from <i>n2</i> and <i>n3</i> , as follows:

**Table 12 Select Attributes (*n1*)**

<i>n1</i> Hex Value	Function
03	Set character height and line feed settings according to the value of <i>n2</i> (If <i>n1</i> = 03, there is no <i>n3</i> .)
04	Set character height, line feed, and character settings according to the values of <i>n2</i> and <i>n3</i> .

Parameter *n2* defines the height attributes, as follows:



**Table 13 Select Attributes (n2)**

<b>n2 Hex Value</b>	<b>Function</b>
00	No change
01	Set single line height characters
02	Set double height characters
10	Set single line spacing
11	Set single height characters and single line spacing
12	Set double height characters and single line spacing
20	Set double line spacing
21	Set single height characters and double line spacing
22	Set double height characters and double line spacing

Parameter *n3* defines the width attributes, as follows:

**Table 14 Select Attributes (n3)**

<b>n3 Hex</b>	<b>Function</b>
00	No change
01	Set single wide characters
02	Set double wide characters

An ESC [ @ code can occur at any place in the datastream and is acted upon immediately. All numerical parameters are in the hex 00 through FF range unless stated otherwise.

### **Superscript/Subscript Printing**

**ASCII**        ESC S *n*

**Hex**         1B 53 *n*

**Dec**         27 83 *n*

**Purpose**       Selects superscript or subscript printing.

**where:**       *n* may range from 0 through 255

*n* = 01, 03, 05 (any odd value), selects subscript printing.

*n* = 00, 02, 04 (any even value), selects superscript printing.

**Discussion**    When the super/subscript command is received, all characters will be superscript or subscript until reset by the super/subscript reset command or printer reset. Super/subscript print modes are not available for the double high attribute.

**NOTE:** Superscript and subscript characters print at the same size as the current font, shifted up or down relative to the print line.

**Example** The following sample illustrates superscript/subscript printing.

```
CONTROL CODE ESC S 0 SELECTSSUPERSCRIPT
A2+B2=C2
CONTROL CODE ESC S 1 SELECTSSUBSCRIPT
31HEX=49DEC
CONTROL CODE ESC T CANCELS
SUPERSCRIPT/SUBSCRIPT PRINTING
```

### Superscript/Subscript Printing, Cancel

**ASCII** ESC T

**Hex** 1B 54

**Dec** 27 84

**Purpose** Cancels superscript and subscript printing (as set by ESC S). This code can occur at any place in the datastream and is acted upon immediately.

### Super-Set Commands

**ASCII** ESC | } ;

**HEX** 1B 7C 7D 3B

**Dec** 27 124 125 59

**Purpose** Control code sequence used to introduce the super-set commands.

**Discussion** The “|” in the command string is the pipe symbol.

**Comment** Super-set commands affect the ASCII emulation as a whole regardless of the printer protocol currently active. The commands are sent through the host in the input data stream, and enact the following features:

- Select a printer protocol
- Bar codes
- Set variable character spacing
- Set variable line spacing

Refer to Chapter 7, Super-Set Programming, for further information regarding the super-set commands.

### Set Top-of-Form

**ASCII** ESC 4

**Hex** 1B 34

**Dec** 27 52

**Purpose** Sets the current paper position as the top-of-form.

## Tab, Horizontal

**ASCII** HT

**Hex** 09

**Dec** 09

**Purpose** Moves the logical printhead right to the next horizontal tab stop.

**Discussion** Power-on default horizontal tabs are set at every eighth character starting at position 9 (9, 17, 25 ...). If there are no horizontal tabs set or the logical printhead is located at the last character column, the code is ignored and no movement occurs.

If double-wide, double-high attributes are enabled, single-wide character spacing is used.

Horizontal tabs are stored as a relative position; therefore, character pitch changes will change horizontal tab positions. Refer to the ESC D control code description (page 43) to set new tab positions.

## Tab Set/Clear, Horizontal

**ASCII** ESC D *n1 n2...nk* NUL

**Hex** 1B 44 *n1 n2...nk* 00

**Dec** 27 68 *n1 n2...nk* 0

**Purpose** Sets up to 28 horizontal tab positions.

**Discussion** *n1*, *n2*, up to *nk* denote character column positions for tab stops (at the current character pitch), where *n1* and *n2* represent the first two tab stops and *nk* is the final tab stop. You may specify from 1 up to 28 tab stops (all parameters after 28 are ignored). The leftmost character column position is 1. The value for each tab stop can range from 1 through 255, inclusive, and all tabs must be specified in ascending order. Any out-of-order symbols are ignored, though the remainder of the sequence is processed.

If you are defining a sequence of tabs, terminate the string with a NUL (*not* an ESC D NUL). If you want *every column* to be set with a horizontal tab, use ESC D NUL. If only one tab position is set and it is beyond the right margin, then every column is also set as a horizontal tab.

Any change in character pitch within a line changes the tab positions for the entire line. All control codes that define horizontal distance expressed in units of characters are stored internally in character columns.

**Example** The following example illustrates horizontal tab setting and accessing.

```
Control code
ESC D CHR$(4);CHR$(10);CHR$(0)
sets tab stops at columns 4 and 10.
Control code HT
accesses the tab stops as follows:
    column 4
    column 10
```

## Tab, Vertical

**ASCII** VT

**Hex** 0B

**Dec** 11

**Purpose** Prints the data in the buffer and advances the paper to the next vertical tab position.

**Discussion** In the Proprinter III XL emulation, vertical tab positions are set by control code ESC B and executed by control code VT. In this mode, if vertical tabs are loaded, the paper position moves to the next vertical tab position.

If a vertical tab format is not defined, the paper position is advanced to the next line at the current line spacing. If a vertical tab format is defined but no vertical tab positions are set between the current print position and the end of the form, the paper position is advanced to the top of the next form. The VT code resets all single line print attributes. More information on vertical tabs is provided in Chapter 9.

If configured for LF = CR + LF (LF equals new line), the character position indicator is positioned at character column 1 of the new line. Otherwise, the character position indicator does not move.

## Tab Set/Clear, Vertical

**ASCII** ESC B *n1 n2 ... nk* NUL

**Hex** 1B 42 *n1 n2 nk* 00

**Dec** 27 66 *n1 n2 nk* 0

**Purpose** Sets or clears vertical tab positions.

**Discussion** The physical position on the paper is defined by *n* and the current line spacing.

**where:** *n* = vertical tab setting (in lines), and *k* = number of tabs possible.

The value of *n* can be defined in the range of 1 through 255, inclusive, while *k* is defined in the range of 1 through 64. Any value for *k* over 64 is ignored. Subsequent line spacing changes affect the tab position. If the value of *n* exceeds the forms length, that tab position is ignored.

Vertical tab positions are set by the command ESC B and executed by the command VT. The tab positions must be in ascending order, or the emulation ignores the out-of-order symbols. If the ESC B command is followed immediately by 00H, the vertical tab positions are cleared.

**Example** The following sample illustrates Vertical Tab Setting. To run the sample, set your printer at top-of-form.

```
Line one -- The control code
ESC B 5 10 0 sets a vertical tab at line 5 and at line 10.
Control code VT moves paper to the next vertical tab.
```

```
Control code VT moves paper to the next vertical tab.
```

```
This is line ten.
```

## **Tabs, Clear All (Return to default)**

<b>ASCII</b>	ESC R
<b>Hex</b>	1B 52
<b>Dec</b>	27 82
<b>Purpose</b>	Clears all horizontal and vertical tab stops.
<b>Discussion</b>	When ESC R is invoked, horizontal tab stops reinitialize to every eight columns, starting at column 9 (9, 17, 25,...). In addition, the vertical tabs are cleared.

## **Underline**

<b>ASCII</b>	ESC – <i>n</i>
<b>Hex</b>	1B 2D <i>n</i>
<b>Dec</b>	27 45 <i>n</i>
<b>Purpose</b>	Enables or disables automatic underlining of all characters.
<b>Discussion</b>	When automatic underline is enabled, all characters, including spaces, are underlined until disabled.
<b>where:</b>	<i>n</i> may range from 0 through 255 <i>n</i> = 01, 03, 05 ... (any odd value) selects underlining. <i>n</i> = 00, 02, 04 ... (any even value) cancels underlining.
<b>Example</b>	The following sample illustrates automatic underlining and underlining reset.

```
Control code ESC -1
enables automatic underlining.
Control code ESC -0
disables automatic underlining.
```

## **Unidirectional Printing**

<b>ASCII</b>	ESC U <i>n</i>
<b>Hex</b>	1B 55 <i>n</i>
<b>Dec</b>	27 85 <i>n</i>
<b>Purpose</b>	Sets or cancels unidirectional printing.
<b>Discussion</b>	This code sets or cancels unidirectional printing, as follows:
<b>where:</b>	<i>n</i> may range from 0 through 255 <i>n</i> = 01, 03, 05 ... (any odd value) selects unidirectional text printing. <i>n</i> = 00, 02, 04 ... (any even value) cancels unidirectional text printing.



# 3 *Epson FX-1050 Emulation*

## Overview

This chapter describes the Epson FX emulation host control codes. “Emulation” refers to the ability of a printer to execute the commands of a particular printer control language. A printer control language is the coding system used to convey, manipulate, and print data. It contains character codes and command sequences that configure the emulation. In this manual, the terms emulation, printer protocol, and printer control language are synonymous.

In Epson FX emulation mode, your printer can print files coded for the Epson FX printer control language. To select the Epson FX emulation as the active printer emulation, select LinePrinter Plus from the EMULATION menu and Epson FX from the Printer Protocol menu, as described in the *Administrator's Manual*.

The Epson FX emulation provides many configurable parameters. The default parameter values for this emulation are shown in Table 15. You can modify these parameter values in two ways:

- **The Epson FX host control codes.** An extensive set of Epson FX control code commands can be sent to the printer from an attached host computer via the host data stream. Most of this chapter is devoted to describing the Epson FX control code commands.
- **The printer configuration menus.** You can modify a subset of the Epson FX emulation parameters using the control panel keys and LCD display, as described in the *Administrator's Manual*.

A parameter value set by a host control code generally overrides a value set from the printer's control panel.

Configuration values selected from the menus or via host control codes can be saved to the printer's NVRAM memory so that they will not be lost when you power off the printer or reset it to the factory defaults. The menu selection for saving a configuration to memory is described in the *Administrator's Manual*. Refer to Appendix B, PTX\_SETUP Commands to save the configuration using host control codes.

## Default Values and States

Your printer memory stores a set of typical operating states and conditions for the Epson emulation. When you power on the printer and select this emulation, the factory settings in Table 15 are automatically invoked.

**Table 15 Epson Emulation Default Settings**

Characteristic	Default Setting
Character Set	Epson Set
Epson Print Language	ASCII (USA)
Define CR Code	CR = CR
Auto Line Feed	Enable
Define LF Code	LF = LF
Printer Select	Disable
20 CPI Condensed	Enable

Table 16 lists several additional default settings for parameters that are provided by the Print Format menus (described in the *Administrator's Manual*). Many of the settings shown in Table 16 can be overridden by Epson FX-1050 host control codes for the same parameter.

**Table 16 Print Format Default Settings**

Characteristic	Default Settings
CPI	10.0
LPI	6.0
Forms Width	13.6 inches 345.4 millimeters 136 characters
Forms Length	11.0 inches 279 millimeters 66 lines
Print Quality	DP Quality
Proportional Spacing	Disable
Italic Print	Disable
Slashed Zero	Disable
Left Margin	0 columns
Right Margin	0 columns
Bottom Margin	0 lines
Perforation Skip	Disable

## Epson Emulation Exceptions and Differences

Because of mechanical differences between your printer(s) (line matrix printers) and Epson printers (moving printhead serial matrix printers), some Epson features are approximated or not supported.

- Epson codes that produce different behavior in your printer are indicated by a “dagger” (†) in the Control Code Index and code section.
- The Epson emulation supports the following fonts: DP, NLQ Serif and Sans Serif, Draft with 10 cpi, 12 cpi and 15 cpi in either condensed or normal widths, and OCR A and OCR B in 10 cpi. Condensed printing at 10 cpi in DP quality maps to 17.1 cpi. Character pitches other than 10 DP cpi map to 20 cpi in DP and 17.1 cpi in NLQ.
- Epson bit-image graphics are supported, including all plotter and CRT densities.
- Many character sets are available, including IBM-PC Graphics (IBM Code Page 0437) and Epson. You can configure the zero character to contain a slash or no slash.
- The Double Wide print control codes (ESC W, SO) double character width, but *not* inter-character spacing, unlike the Epson FX-1050. The formulas for total character spacing are as follows:

Epson FX-1050                    2 (char + 1 dot + space)

Epson Emulation                2 (char + 1 dot) + space



- The Condensed Print (SI) control code condenses character width but *not* inter-character spacing, unlike the Epson FX-1050 which condenses both character width *and* spacing.
- If one or more Backspace control codes follow directly after a Bit Image Graphics command (ESC K, ESC L, ESC Y, or ESC Z), the printer will backspace into the graphic pattern, the number of dots depending on the current cpi setting. For an Epson FX-1050 printer, one Backspace will send the logical printhead directly to the beginning of the graphics pattern.
- When backspacing over proportionally spaced characters, Epson printers move back the width of each proportional character; this emulation moves back based on the current cpi setting, as if proportional spacing is disabled.

## Epson Character Sets

Epson printers use five character sets. The IBM Graphics code page 437, IBM PC Multilingual code page 0850, OCR A, and OCR B character sets may be selected from the configuration menus. In addition, there is a unique Epson character set. The Epson character set (shown in Table 17) is basically the ASCII character set with the upper, non-ASCII set defined as italics, and the usually unprintable codes designated as international characters.

**Table 17 Epson Character Set**

Hex	0	1	2	3	4	5	6	7	8	9	A	B	C	D	E	F
0	à	§	SP	0	@	P	'	p	à	§	SP	0	@	P	'	p
1	è	ß	!	1	A	Q	a	q	è	ß	!	1	A	Q	a	q
2	ù	DC2	“	2	B	R	b	r	ù	Æ	“	2	B	R	b	r
3	ò	DC3	#	3	C	S	c	s	ò	æ	#	3	C	S	c	s
4	ì	DC4	\$	4	D	T	d	t	ì	ø	\$	4	D	T	d	t
5	°	ø	%	5	E	U	e	u	°	ø	%	5	E	U	e	u
6	£	ˆ	&	6	F	V	f	v	£	ˆ	&	6	F	V	f	v
7	BEL	Ä	'	7	G	W	g	w	i	Ä	'	7	G	W	g	w
8	BS	CAN	(	8	H	X	h	x	ı	Ö	(	8	H	X	h	x
9	HT	Ü	)	9	I	Y	i	y	Ñ	Û	)	9	I	Y	i	y
A	LF	ä	*	:	J	Z	j	z	ñ	ä	*	:	J	Z	j	z
B	VT	ESC	+	;	K	[	k	{	ı	ö	+	;	K	[	k	{
C	FF	ü	'	<	L	\	l		Pt	ü	,	<	L	\	l	
D	CR	É	-	=	M	]	m	}	Á	É	-	=	M	]	m	}
E	SO	é	.	>	N	^	n	~	â	é	.	>	N	^	n	~
F	SI	¥	/	?	O	_	o	DEL	Ç	¥	/	?	O	_	o	ø

The international characters in hex 00-1F and hex 80-9F appear when you invoke control code “ESC I 1”. You may use the Epson configuration menus described in the *Administrator’s Manual* (or the “ESC R” control code) to select an international character set. Table 18 provides detailed notes on print mode support for each character set.

Normally, these characters are either blank or control codes. The implementation is that the control codes hide the non-italic international characters, even in hex 00 through 1F, and DEL. DEL conceals the non-italic slashed zero.

## Configuring the Epson FX-1050 Emulation with Control Codes

The remainder of this chapter describes the Epson printer control language codes that may be sent from a host computer attached to the printer, in order to invoke and configure numerous Epson emulation functions.

### Format for Control Code Descriptions

The following information is listed for each control code (where applicable):

<b>Name</b>	The title or function of the command.
<b>ASCII</b>	The ASCII mnemonic for the command. Command sequences are in 7-bit (ASCII) form.
<b>Hex</b>	The code or command sequence in hexadecimal numbers.
<b>Dec</b>	The code or command sequence in decimal numbers.
<b>Purpose</b>	The function(s) of the control code.
<b>Discussion</b>	A discussion of the uses of the code or command sequence, including a description of exceptions or limitations to normal use.
<b>Example</b>	A sample output is provided when it is possible to illustrate the effect of a control code or if a specific syntax is required.

† This symbol means the code produces non-Epson behavior in your printer.

**IMPORTANT** If you specify any parameters for a control code other than the ones that are defined in the control code description, unpredictable results may occur.

### Escape Sequences

An Epson control code consisting of more than one character is called an escape sequence because the first character in the sequence is always the ASCII ESCape character. ESC alerts the printer that a special function command—not printable characters—follows.

The format for an Epson escape sequence is: (ESC)(parameter 1)(parameter 2)...(parameter *n*)

For example, to select emphasized (offset) print, send the ESC character immediately followed by the E character (do not add a space character):

**ASCII:** ESC E                    **Hex:** 1B 45                    **Dec:** 27 69

### Set and Reset Codes

Set and reset are another way of saying turn on and turn off, select and deselect, or enable and disable.

Some printer features are set and reset with an escape sequence and the numbers 1 or 0. In such cases you can represent 1 and 0 as hexadecimal codes 01 and 00, or as the ASCII codes for the numerals 1 and 0 (hexadecimal 31 and 30).

## NUL Code

NUL (hex 00) is ignored by the printer and can be used as a fill character; however, it can not be used to add blank spaces since it is not a space character. NUL can also be used as a parameter terminator for the Set Horizontal Tabs (page 68) or Set Vertical Tabs multibyte control code (page 87).

**NOTE:** Hex 80 in the 0437 PC Character Set and Hex 7F in the 0850 PC Character Set are treated as a NUL; however, these two controls can not be used as parameter terminators.

## Print Modes Supported for Character Sets

Following is a summary of which print modes are supported for the Epson FX- 1050 emulation character sets. Additional information about character set support is provided under the heading “Notes.”

**NOTE:** The print mode support for the languages shown in Table 18 (Epson Set ASCII and following) is the same for the Epson expanded character sets and the Epson 0437 PC character sets.

**Table 18 Character Set Print Mode Support**

Character Set	NLQ(Serif)/DP/Draft	Notes
OCR-A / OCR-B	N/A	OCR is 10 cpi only
0437 PC Character Set	X	
0737 Greek	X	
0813 Greek	X	
0819 ISO/ANSI Multilingual		
0850 PC Multilingual	X	
0851 Greek Old	X	
0852 Latin 2/Roece	X	
0853 Latin 3	X	
0855 Cyrillic	X	
0857 Turkish	X	
0858 PC Euro Multilingual	X	
0860 Portuguese	X	
0861 Icelandic	X	
0862 Hebrew	X	
0863 French Canadian	X	
0864 Arabic	X	
0865 Danish/Norwegian	X	
0866 Cyrillic	X	
0869 Greek New	X	
0874 Thai	X	

**Table 18 Character Set Print Mode Support**

<b>Character Set</b>	<b>NLQ(Serif)/DP/Draft</b>	<b>Notes</b>
0912 ISO Latin 2 PC	X	
0913 ISO Latin 3	X	
0914 ISO Latin 4	X	
0915 ISO Cyrillic PC	X	
0916 Hebrew	X	
0920 ISO Latin 5 Turkish	X	
0921 ISO Baltic Multilingual	X	
0922 Estonian	X	
0923 Latin 9 8859-15	X	
1006 ISO Urdu	X	
1008 ISO Arabic	X	
1046 Arabic Extended	X	
1089 ISO Arabic	X	
1098 Farsi 1285	X	
1116 Estonian	X	
1117 Latvian	X	
1118 Lithuanian	X	
1129 Vietnamese	X	
1134 Hebrew Old	X	
Epson Set ASCII (USA)	X	
Epson Set French	X	
Epson Set German	X	
Epson Set English (UK)	X	
Epson Set Danish I	X	
Epson Set Swedish	X	
Epson Set Italian	X	
Epson Set Spanish I	X	
Epson Set Japanese	X	
Epson Set Norwegian	X	
Epson Set Danish II	X	

**Table 18 Character Set Print Mode Support**

Character Set	NLQ(Serif)/DP/Draft	Notes
Epson Set Spanish II	X	
Epson Set Latin American I	X	
Epson Set French Canadian	X	
Epson Set Latin American II	X	

## The Control Codes

The following index lists the control codes by function, ASCII mnemonic, and page number. Some control code functions can also be selected at the operator panel.

† = Produces non-Epson behavior in your printer.

FUNCTION	ASCII CODE	PAGE
<b>Vertical Motion and Print Execution</b>		
Carriage Return	CR	56
Form Feed	FF	64
Line Feed	LF	69
Line Feed <i>n</i> /216 Inch	ESC J <i>n</i>	70
Line Spacing 1/6 Inch (6 lpi)	ESC 2	70
Line Spacing 1/8 Inch (8 lpi)	ESC 0	71
Line Spacing 7/72 Inch	ESC 1	71
Line Spacing <i>n</i> /216 Inch	ESC 3 <i>n</i>	71
† Line Spacing <i>n</i> /72 Inch	ESC A <i>n</i>	72
† Paper Out Detection, Enable	ESC 9	75
† Paper Out Detection, Disable	ESC 8	75
Reverse Line Spacing <i>n</i> /216 Inch	ESC j <i>n</i>	77
Select Vertical Tab Channel	ESC / <i>c</i>	80
† Set Form Length by Lines	ESC C <i>n</i>	82
Set Form Length in Inches	ESC C NUL <i>n</i>	83
Set Vertical Tabs in Channels	ESC b <i>c n1 n2 n3 ... n16</i> NUL	83
Skip Over Perforation	ESC N <i>n</i>	84
Skip Over Perforation, Cancel	ESC O	84
Vertical Tab, Execute	VT	86
Vertical Tab Set/Clear	ESC B <i>n1 n2 n3...nk</i> NUL	87

FUNCTION	ASCII CODE	PAGE
<b>Horizontal Motion</b>		
† Backspace	BS	55
Carriage Return	CR	56
Character Pitch 10 cpi	ESC P	56
Character Pitch 12 cpi	ESC M	57
Horizontal Tab Execute	HT	68
Horizontal Tab Set/Release	ESC D <i>n1 ... nk</i> NUL	68
Select/Deselect Proportional Spacing	ESC <i>p n</i>	79
Set Absolute Horizontal		
Print Position in 1/60"	ESC \$ <i>n1 n2</i>	80
Set Relative Horizontal		
Print Position in 1/120"	ESC \ <i>n1 n2</i>	81
Set Intercharacter Spacing in 1/120"	ESC SP <i>n</i>	81
Set Margin, Left	ESC l <i>n</i>	81
Set Margin, Right	ESC Q <i>n</i>	82
<b>Emphasis</b>		
† Condensed Print	SI (or ESC SI)	59
Condensed Print Reset		59
† Double High Print, Set/Reset	ESC w <i>n</i>	60
Double Strike	ESC G	61
Double Strike, Cancel	ESC H	61
† Double Wide Print	ESC W <i>n</i>	61
† Double Wide Print (1 Line)	SO (or ESC SO)	62
Double Wide Print (1 Line), Cancel		62
Emphasized Print	ESC E	63
Emphasized Print, Cancel	ESC F	63
Italic Printing	ESC 4	69
Italic Printing, Cancel	ESC 5	69
Superscript/Subscript Printing, Cancel	ESC T	85
† Superscript/Subscript Printing	ESC S <i>n</i>	84
Underline	ESC - <i>n</i>	85
<b>Print Quality Control</b>		
† Character Pitch 15 cpi	ESC g	57
† Define a Download Character	ESC &	60
† Master Print Select	ESC ! <i>n</i>	75
† Remove Downloaded Characters	ESC : NUL <i>n</i> NUL	77
† Select Print Quality	ESC x <i>n</i>	79
† Select Serif or Sans Serif Font	ESC k <i>n</i>	80
† Select User-Defined Font	ESC % <i>n</i>	80
<b>Character Set Manipulation</b>		
Character Set Select: International Languages	ESC R <i>n</i>	57
Enable Printing of Hex Codes 00-1F and 80-9F	ESC l <i>n</i>	63
Make Hex 80-9F Printable	ESC 6	73
Make Hex 80-9F Control Codes	ESC 7	72
Select Italic Character Set	ESC t <i>n</i>	78

FUNCTION	ASCII CODE	PAGE
<b>Data Manipulation</b>		
Cancel Line	CAN	56
† Clear Bit 7 of Incoming Data Bytes to 0	ESC =	58
Delete Character	DEL	60
Pass Bit 7 from Host	ESC #	76
Set Bit 7 of Incoming Data Bytes to 1	ESC >	81
<b>Graphics</b>		
Graphics, Standard Density	ESC K <i>n1 n2</i>	66
Graphics, Double Density	ESC L <i>n1 n2</i>	66
Graphics, Double Density Double Speed	ESC Y <i>n1 n2</i>	67
Graphics, Quadruple Density	ESC Z <i>n1 n2</i>	67
Reassign Graphics Mode	ESC ? <i>s m</i>	76
† Select Graphics Mode	ESC * <i>m n1 n2</i>	77
Select 9-Pin Graphics Mode	ESC ^ <i>m n1 n2 d1 ... dk</i>	79
<b>Miscellaneous Printer Control</b>		
Bell	BEL	56
† Cut-Sheet/Paper Feed Control	ESC EM <i>n</i>	60
† Half-Speed Mode, On/Off	ESC <i>s n</i>	68
Initialize Printer	ESC @	69
Printer Select	DC1	76
Printer Deselect	DC3	76
Super-Set Commands	ESC   } ;	85
Unidirectional Printing, 1 Line	ESC <	86
Unidirectional Printing, Set/Reset	ESC U <i>n</i>	86

## Backspace

**ASCII** BS

**Hex** 08

**Dec** 08

**Purpose** Moves the logical print head to the left one character space toward the first character column.

**Discussion** Assures that the previous printable characters will be printed, then moves the logical print head one character space to the left at the current pitch setting (which includes double wide and ESC SP). If the logical print head bumps into the left margin, it stops.

† When backspacing over proportionally spaced characters, Epson printers move back the width of each proportional character; this emulation moves back based on the current cpi setting, as if proportional spacing is disabled.

† If one or more Backspace control codes follow directly after a Bit Image Graphics command (ESC K, ESC L, ESC Y, or ESC Z), your printer will backspace into the graphic pattern, the number of dots depending on the current cpi setting. For an Epson FX-1050 printer, one Backspace will send the logical printhead directly to the beginning of the graphics pattern.

**Example** If you were to print five “T” characters, then two BS commands, then two “=” characters, the output would look like the sample below:

TTT#=#

## **Bell**

**ASCII** BEL

**Hex** 07

**Dec** 07

**Purpose** Sounds the printer buzzer/beeper.

**Discussion** The BEL function will sound the buzzer/beeper for 0.2 seconds upon receipt of this command.

## **Cancel Line**

**ASCII** CAN

**Hex** 18

**Dec** 24

**Purpose** Clears all unprinted data from a line, but does not affect control codes.

**Discussion** You can use this control code to delete a line, but do so with caution to avoid possible misprinting. This control code cancels the double wide attribute set by SO. No other print attributes are affected. The logical print head goes to the print position it had after the last CR or paper motion command.

## **Carriage Return**

**ASCII** CR

**Hex** 0D

**Dec** 13

**Purpose** Prints the data in the buffer, then returns the logical print head to the left margin.

**Discussion** Subsequent data are emphasized. A line feed will be appended if the printer is configured from the operator panel for CR = CR + LF. When CR = CR + LF, this code cancels all one-line-only emphasis and font controls: double-wide from SO and ESC SO, and unidirectional printing from ESC <.

## **Character Pitch 10 CPI**

**ASCII** ESC P

**Hex** 1B 50

**Dec** 27 80

**Purpose** Sets character pitch to 10 characters per inch (cpi).

**Discussion** This command is normally used to cancel 12 cpi.



### Character Pitch 12 CPI

**ASCII**        ESC M

**Hex**         1B 4D

**Dec**         27 77

**Purpose**       Sets character pitch to 12 characters per inch (cpi).

**Discussion**    This command is available in all print modes except OCR A and OCR B.

### Character Pitch 15 CPI

**ASCII**        ESC g

**Hex**         1B 67

**Dec**         27 103

**Purpose**       Sets character pitch to 15 characters per inch (cpi).

†**Discussion**    This command is not defined in Epson FX printers. It is included in this emulation for compatibility with the Okidata KX-P1180 printer. This command is available in all print modes except OCR A and OCR B.

### Character Set Select: International Languages

**ASCII**        ESC R *n*

**Hex**         1B 52 *n*

**Dec**         27 82 *n*

**Purpose**       Specifies a language overlay that prints the characters shown in Table 19 when the specified code is invoked.

**where:**       *n* = hex 0 through E to determine the language overlay shown in Table 19 below. Epson only defines character sets through hex C.

**Table 19 Epson International Character Sets**

(Hex) If n=	International Character Set is:	23	24	40	5B	5C	5D	5E	60	7B	7C	7D	7E
0	USA	#	\$	@	[	\	]	^	'	{		}	~
1	French	#	\$	à	°	ç	§	^	'	é	ù	è	¨
2	German	#	\$	§	Ä	Ö	Ü	^	'	ä	ö	ü	ß
3	English (UK)	£	\$	@	[	\	]	^	'	{		}	~
4	Danish I	#	\$	@	Æ	Ø	Å	^	'	æ	ø	å	~
5	Swedish	#	¤	É	Ä	ö	Å	Ü	é	ä	ö	å	ü
6	Italian	#	\$	@	°	\	é	^	ù	à	ò	è	ì
7	Spanish I		\$	@	i	Ñ	¿	^	'	¨	ñ	}	~
8	Japanese	#	\$	@	[	¥	]	^	'	{		}	~
9	Norwegian	#	¤	É	Æ	Ø	Å	Ü	é	æ	ø	å	ü
A	Danish II	#	\$	É	Æ	Ø	Å	Ü	é	æ	ø	å	ü
B	Spanish II	#	\$	à	i	Ñ	¿	é	'	í	ñ	ó	ú
C	Latin American I	#	\$	à	i	Ñ	¿	é	ü	í	ñ	ó	ú
D	French Canadian	#	\$	à	â	ç	ê	î	ô	é	ù	é	û
E	Latin American II	#	\$	@	[	Ñ	]	ú	í	ó	á	é	ü

**Discussion** This control code setting overrides a character set selection made at the operator panel.

**Example** The following example illustrates international character selection using the IBM PC character set.

```
Control code ESC R 5 selects
the Swedish character set shown beneath
the USA (ASCII) characters.
```

```
A B C D [ \ ] ^ - ` { | } ~
A B C D Ä ö Å Ü - é ä ö å ü
```

### Clear Bit 7 of Incoming Data Bytes to 0

**ASCII** ESC =

**Hex** 1B 3D

**Dec** 27 61

**Purpose** Sets the most significant bit (MSB) of all incoming data to 0.

**Discussion** The MSB is bit number 7. This command only affects text and control code data. Graphics data pass through unchanged. Some applications always set the MSB of print data to one (1), which results in italic or graphics printing in Epson printers. This command overcomes the problem.

**NOTE:** This command does not suppress hex FF from printing.

## Condensed Print

**ASCII** SI ESC SI

**Hex** 0F 1B 0F

**Dec** 15 27 15

**Purpose** Condenses print pitch as close to 60% of the former character width as possible (up to 20 characters per inch).

**Discussion** The condensed print command affects all subsequent characters. After the printer receives code SI, all characters are printed condensed (approximately 60 per cent of the width of normal characters) until the printer is reset by ESC M, ESC P, DC2, a printer reset, or a new print mode control code. SI code (hex 0F) is equivalent to the ESC SI code. If condensed print is not allowed in the current font, this code is ignored. Proportionally spaced text cannot be condensed. Proportional spacing overrides condensed printing.

When condensed print is selected, the following character pitches go into effect:

- DP 10 cpi condenses to DP 17.1 cpi. NLQ 10, 12, and 15 cpi condense to NLQ 17.1 cpi. Draft 10 cpi condenses to Draft 17.1 cpi.
- DP 12 and 15 cpi condense to DP 20. Draft 12 and 15 cpi condense to Draft 20.

† This control code condenses character width but not inter-character spacing. An actual Epson FX-1050 printer condenses both character width and spacing. If Condensed Print is combined with Double High (ESC w) printing, *only* Double High printing will occur.

**Example** The sample output below shows condensed character printing and reset.

```
Control code
SI selects
condensed character printing.
Control code DC2
resets condensed character printing.
```

## Condensed Print Reset

**ASCII** DC2

**Hex** 12

**Dec** 18

**Purpose** Cancels the condensed print mode set by SI, ESC SI, or the operator panel.

**Discussion** This returns the printer to the font that was active before condensed print occurred. Other print attributes are not affected.

**Example** See the Condensed Print control code (page 59) for an example of Condensed Print Reset.

## Cut-Sheet / Paper Feed Control

<b>ASCII</b>	ESC EM <i>n</i>
<b>Hex</b>	1B 19 <i>n</i>
<b>Dec</b>	27 25 <i>n</i>
<b>Purpose</b>	This code controls the paper feed mechanism on Epson printers.
<b>†Discussion</b>	The printer ignores this command.

## Define a Download Character

<b>ASCII</b>	ESC &
<b>Hex</b>	1B 26
<b>Dec</b>	27 38
<b>Purpose</b>	Defines a download character.
<b>†Discussion</b>	The printer ignores this command and removes all downloaded font data from the data stream.

## Delete Character

<b>ASCII</b>	DEL
<b>Hex</b>	7F
<b>Dec</b>	127
<b>Purpose</b>	Deletes the previous character on a line.
<b>Discussion</b>	This command is ignored if it occurs immediately after a CR or a paper motion command. Characters truncated due to line length restrictions are not affected by this code.

## Double High Print, Set/Reset

<b>ASCII</b>	ESC w <i>n</i>
<b>Hex</b>	1B 77 <i>n</i>
<b>Dec</b>	27 119 <i>n</i>

**Purpose** Turns double-high character printing on and off. Double-high characters are standard width but twice as high.

**where:** *n* = hex 1 or hex 31 turns double high printing on  
*n* = hex 0 or hex 30 turns double high printing off

**†Discussion** The OCR A and OCR B fonts cannot be printed in double high.

**NOTE:** It is recommended to use double Line Feeds and Carriage Returns when double-high character printing is on (after an ESC w control code has been sent), or else the printer will overstrike text that has already printed.

† If Superscript/Subscript (ESC S) or Condensed Print (SI) is combined with Double High printing, *only* Double High printing will occur.

**Example** The following sample output illustrates double-high character printing.

```
Control Code ESC w
Selects Double High printing.
Cancels Double High printing.
```

## Double Strike

**ASCII** ESC G

**Hex** 1B 47

**Dec** 27 71

**Purpose** Makes text bolder by double printing each dot twice.

**†Discussion** This command makes text bolder by printing each dot twice, the second dot offset to the right of the first by a distance equal to 1/2 the width of a dot, the same as with ESC E.

**Example** The following sample output illustrates double strike character printing.

```
Control code ESC G
selects bold character printing,
for example: AaBbCcDdEeFfGgHhIiJjKkLlMmNnOoPp.
Control code ESC H
cancels bold character printing.
```

## Double Strike, Cancel

**ASCII** ESC H

**Hex** 1B 48

**Dec** 27 72

**Purpose** Turns off the double strike printing set by ESC G or ESC !.

**Discussion** This control code resets only the double strike print attribute. Other print attributes, such as double wide printing, are not affected.

## Double Wide Print

**ASCII** ESC W *n*

**Hex** 1B 57 *n*

**Dec** 27 87 *n*

**Purpose** Turns double wide print on and off.

**where:** *n* = hex 1 or hex 31 turns double wide print on

*n* = hex 0 or hex 30 turns double wide print off

**Discussion** When ESC W is received, all characters are printed twice as wide until reset. This command overrides SO, ESC SO, and DC4. The OCR A and OCR B fonts cannot be printed in double wide.

† This control code doubles character width, but does *not* double inter-character spacing, unlike the Epson FX-1050. The formulas for total character spacing are as follows:

Epson FX-1050            2(char + 1 dot + space)

Epson Emulation        2(char + 1 dot) + space

**Example**            The following sample output illustrates double wide character printing.

```
Control code
ESC W 1 selects
expanded character printing.
Control code
ESC W 0 resets
expanded character printing.
```

### Double Wide Print (1 Line)

**ASCII**            SO    ESC SO

**Hex**            0E    1B 0E

**Dec**            14    27 14

**Purpose**           Selects double wide print for one line only.

**Discussion** This control code is a line-by-line print attribute; when SO or ESC SO is received, the characters on the current line print twice as wide, then automatically reset.

† This control code is cancelled by the DC4 code or by a CR code, as in the Epson FX-1050. It is *also* cancelled by a paper motion control code (LF, VT, etc.), as in the IBM Proprinter III XL.

† This control code doubles character width, but does *not* double inter-character spacing, unlike the Epson FX-1050. The formulas for total character spacing are as follows:

Epson FX-1050            2(char + 1 dot + space)

Epson Emulation        2(char + 1 dot) + space

**Example**            The following sample output illustrates double wide print for one line only.

```
Control code
SO selects
expanded character printing
for one line only.
```

### Double Wide Print (1 Line), Cancel

**ASCII**            DC4

**Hex**            14

**Dec**            20

**Purpose**            Cancels the double wide print for one line only selected by SO or ESC SO.

**Discussion** This command cancels the double wide print selected by SO or ESC SO, but does not cancel double wide printing selected by ESC W or ESC !.

## Emphasized Print

<b>ASCII</b>	ESC E
<b>Hex</b>	1B 45
<b>Dec</b>	27 69
<b>Purpose</b>	Selects emphasized character print format.
<b>Discussion</b>	Emphasized print makes text bolder by printing each dot twice, the second dot offset to the right of the first by a distance equal to 1/2 the width of a dot. This command is available in both DP and NLQ modes.
<b>Example</b>	The following sample output illustrates emphasized character printing.

```
Control code  
ESC E selects  
emphasized character printing.  
Control code ESC F  
cancels emphasized character printing.
```

## Emphasized Print, Cancel

<b>ASCII</b>	ESC F
<b>Hex</b>	1B 46
<b>Dec</b>	27 70
<b>Purpose</b>	Cancels emphasized character printing selected by ESC E or ESC I.
<b>Discussion</b>	This command is available in both DP and NLQ modes.

## Enable Printing Hex Codes 00-1F and 80-9F

<b>ASCII</b>	ESC I <i>n</i> (uppercase "i")
<b>Hex</b>	1B 49 <i>n</i>
<b>Dec</b>	27 73 <i>n</i>
<b>Purpose</b>	Permits you to print hex codes 00-1F and 80-9F.
<b>where:</b>	<i>n</i> = 1 allows hex codes 00-1F and 80-9F to be printable and to be used for user-defined characters. <i>n</i> = 0 returns hex 00-1F and 80-9F to control codes.
<b>Discussion</b>	The printable characters that are included in hex codes 00 through 1F and 80 through 9F are usually not printable in the default state on Epson printers. Sending ESC I 1 enables you to print characters in this range. Sending ESC I 0 returns the codes to non-printable status.  The printable codes for the Epson character set are shown in Figure 1. Figure 1 shows the types of characters and their addresses; it is not a sample of printer output.

## Form Feed

**ASCII** FF

**Hex** 0C

**Dec** 12

**Purpose** Prints the data in the buffer, if any, then moves the paper to the top of the next form.

**Discussion** The logical print head moves to the left margin. This code cancels all one-line-only emphasis and font controls: double- wide from SO and ESC SO, and unidirectional printing from ESC <.



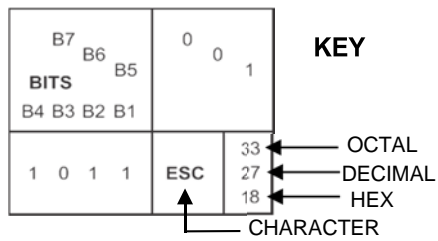

B8 BITS B4 B3 B2 B1	B7 B6 B5 ROW	0 0 0		0 0 0 1	
		COLUMN			
		0		1	
0 0 0 0	0	à	000	§	201610
0 0 0 1	1	è	111	ß	211711
0 0 1 0	2	ù	222	DC2	221812
0 0 1 1	3	ò	333	DC3	231913
0 1 0 0	4	ì	444	DC4	242014
0 1 0 1	5		555	ø	252115
0 1 1 0	6	£	666	..	262216
0 1 1 1	7	BEL	777	Ä	272317
1 0 0 0	8	BS	888	CAN	302418
1 0 0 1	9	HT	999	Ü	312519
1 0 1 0	10	LF	12100A	ä	32261A
1 0 1 1	11	VT	13110B	ESC	33271B
1 1 0 0	12	FF	14120C	ü	34281C
1 1 0 1	13	CR	15130D	É	35291D
1 1 1 0	14	SO	16140E	é	36301E
1 1 1 1	15	SI	17150F	¥	37311F

B8 BITS B4 B3 B2 B1	B7 B6 B5 ROW	1 0 0		1 0 0 1	
		COLUMN			
		8		9	
0 0 0 0	0	à	20012880	§	22014490
0 0 0 1	1	è	20112981	ß	22114591
0 0 1 0	2	ù	20213082	Æ	22214692
0 0 1 1	3	ò	20313183	æ	22314793
0 1 0 0	4	ì	20413284	ø	22414894
0 1 0 1	5		20513385	ø	22514995
0 1 1 0	6	£	20313486	..	22615096
0 1 1 1	7	i	20713587	Ä	22715197
1 0 0 0	8	ı	21013688	Ö	23015298
1 0 0 1	9	Ñ	21113789	Ü	23115399
1 0 1 0	10	ñ	2121388A	ä	2321549A
1 0 1 1	11	ı	2131398B	ö	2331559B
1 1 0 0	12		2141408C	ü	2341569C
1 1 0 1	13	Å	2151418D	É	2351579D
1 1 1 0	14	å	2161428E	é	2361589E
1 1 1 1	15	ç	2171438F	¥	2371599F

Figure 1 Epson Printable Codes (Hex 00-1F and 80-9F)



## Graphics, Double Density Double Speed

**ASCII** ESC Y *n1 n2*

**Hex** 1B 59 *n1 n2*

**Dec** 27 89 *n1 n2*

**Purpose** Selects double density, double speed bit-image graphics of 120 dpi horizontally and 72 dpi vertically.

**where:** (*n1 + 256n2*) defines the number of data bytes to follow.

DATA = ASCII characters for the dot pattern bytes.

**NOTE:** "DATA" consist of 8-bit dot columns, with the MSB at the top, and "1" bits producing dots. For more information, refer to Chapter 8.

**Discussion** This mode prints double density with no adjacent dots. It is similar to ESC L, except that if the graphics data contain horizontally adjacent dots, the data may print incorrectly. This feature is widely used to move the print head precisely, by printing blank dot columns.

**Example** The following example produces a double density, double speed graphic image of the pattern used in the standard density example. The amount of data must be doubled for double density (the data are used 54 times rather than 27).

```
Double Density Double Speed Bit Image Graphics
XXXXXXXXXXXXXXXXXXXXXXXXXXXXXXXXXXXXXXXXXXXXXXXXXXXX
```

## Graphics, Quadruple Density

**ASCII** ESC Z *n1 n2*

**Hex** 1B 5A *n1 n2*

**Dec** 27 90 *n1 n2*

**Purpose** Selects Quadruple Density Bit Image graphics of 240 dpi horizontally and 72 dpi vertically.

**where:** (*n1 + 256n2*) defines the number of data bytes to follow.

DATA = ASCII characters for the dot pattern bytes.

**NOTE:** "DATA" consist of 8-bit dot columns, with the MSB at the top, and "1" bits producing dots. For more information, refer to Chapter 8.

**Discussion** This mode is similar to ESC L, except that four dot columns are printed in the space normally taken by two columns. You can change graphics density with the ESC ? command.

**Example** The following example produces quadruple density graphics of the pattern used in the standard density example. The amount of data must be quadrupled for quadruple density (the data are used 108 times rather than 27).

```
Quad Density Bit Image Graphics
XXXXXXXXXXXXXXXXXXXXXXXXXXXXXXXXXXXXXXXXXXXXXXXXXXXX
```

## Half Speed Mode, On/Off

<b>ASCII</b>	ESC s <i>n</i>
<b>Hex</b>	1B 73 <i>n</i>
<b>Dec</b>	27 115 <i>n</i>
<b>Purpose</b>	Reduces printer speed 50%
<b>where:</b>	<i>n</i> = hex 00 or 30 turns half speed mode off <i>n</i> = hex 01 or 31 turns half speed mode on
<b>†Discussion</b>	This is simulated in your printer by unidirectional printing.

## Horizontal Tab Execute

<b>ASCII</b>	HT
<b>Hex</b>	09
<b>Dec</b>	09
<b>Purpose</b>	Moves the logical print head to the next horizontal tab stop.
<b>Discussion</b>	Power-on default horizontal tabs are set at every eighth character at the current character spacing. Tab positions are not affected by a change of font or character width. Blank spaces between HT stops are underlined in underline mode.

## Horizontal Tab Set/Release

<b>ASCII</b>	ESC D <i>n1</i> ... <i>nk</i> NUL
<b>Hex</b>	1B 44 <i>n1</i> ... <i>nk</i> 00
<b>Dec</b>	27 68 <i>n1</i> ... <i>nk</i> 0
<b>Purpose</b>	Sets up to 32 horizontal tab positions.
<b>where:</b>	<i>n1</i> through <i>n32</i> specify the character column of the tab positions. NUL is the sequence terminator. ESC D NUL clears all tabs.
<b>Discussion</b>	The values of <i>n</i> must be listed in ascending order or they are ignored. Tabs greater than 32 or those positioned beyond the right margin are ignored. The physical tab position is the product of <i>n</i> and the current cell width (1/pitch), excluding double wide.  After the tabs are set, HT moves the logical print head to the next tab stop. Sending ESC @ initializes the printer and resets the tabs to every eighth character column (which is the default). In proportional mode, the size of 10 CPI characters determines tab positions.
<b>Example</b>	The following example illustrates how to set horizontal tabs.

```
Control code
ESC D CHR$(4);CHR$(10);CHR$(0)
sets tab stops at columns 4 and 10.
Control code HT
accesses the tab stops as follows:
    column 4
        column 10
```

## Initialize Printer

**ASCII** ESC @

**Hex** 1B 40

**Dec** 27 64

**Purpose** Resets all print-related parameters to the power-up configuration values.

**Discussion** Restores the power-up configuration values and the print buffer is cleared of printable data on the line preceding the command. Current position is set as top-of-form.

Font, international language selection, forms length, skip-over perforation, and character pitch are reset to the power-up configuration values. Other values are returned to default values.

Character-by-character and line-by-line attributes are canceled. All channels of the vertical format unit are cleared.

This command resets the horizontal tabs to every eighth character column. Interface parameters and printer protocol selection are not affected.

## Italic Printing

**ASCII** ESC 4

**Hex** 1B 34

**Dec** 27 52

**Purpose** Turns on italic character printing.

**Discussion** Character graphics (IBM graphic set hex B0 through DF and F0 through FE) cannot be italicized. Italic printing will reduce throughput.

## Italic Printing, Cancel

**ASCII** ESC 5

**Hex** 1B 35

**Dec** 27 53

**Purpose** Turns off italic character printing.

## Line Feed

**ASCII** LF

**Hex** 0A

**Dec** 10

**Purpose** Prints the data in the buffer (if any) and advances the vertical character position a distance of one line at the current line spacing.

**Discussion** The logical print head keeps the same distance from the margin. The current line is printed and the logical printhead moves down a distance equal to the current line spacing. If there are no dots, paper moves and no printing occurs. When possible, successive line feeds are accumulated and moved at once.

This code cancels all one-line-only emphasis and font selections: double-wide from SO and ESC SO, and unidirectional printing from ESC <.

## Line Feed $n/216$ Inch

**ASCII** ESC J  $n$

**Hex** 1B 4A  $n$

**Dec** 27 74  $n$

**Purpose** Immediately advances the paper  $n/216$  inch.

**where:**  $n = 0$  through 255

**Discussion**  $n = 0$  is ignored. Paper movement occurs in multiples of  $3/216$  inch. This command produces an immediate line feed but does not affect line spacing or produce a carriage return. Any one- line-only print attributes in effect are canceled.

Small values of  $n$  may result in overlapping lines. Overlapping lines may also occur if print attributes such as double high, superscript, or subscript characters are used on the same line.

**Example** The following example illustrates  $n/216$ -inch line spacing.

```
Control code ESC J 200
```

```
performs a 200/216 inch  
line feed function for one line only.
```

## Line Spacing 1/6 Inch (6 lpi)

**ASCII** ESC 2

**Hex** 1B 32

**Dec** 27 50

**Purpose** Sets the line spacing to 1/6 inch (6 lpi) for subsequent line feeds.

**Discussion** The 2 is ASCII *character* 2, not hex 2.

When ESC 2 is received, all lines are printed at 6 lpi until a new line spacing is selected or the printer is reset. This control code overrides line spacing set at the operator panel.

**Example** The following example illustrates 1/6-inch line spacing.

```
Control code ESC 2 sets  
line spacing at  
6 lpi for all subsequent lines  
until reset or another spacing is selected.
```

## Line Spacing 1/8 Inch (8 lpi)

**ASCII** ESC 0

**Hex** 1B 30

**Dec** 27 48

**Purpose** Sets the line spacing to 1/8 inch (8 lpi) for subsequent line feeds.

**Discussion** When ESC 0 is received, all lines are printed at 8 lpi until a new line spacing is selected or the printer is reset. This control code overrides line spacing set at the operator panel.

**Example** The following example illustrates 1/8-inch line spacing.

```
Control code ESC 0 sets
line spacing at
1/8 (8 lpi) inch for all subsequent lines
until reset or another spacing is selected.
```

## Line Spacing 7/72 Inch

**ASCII** ESC 1

**Hex** 1B 31

**Dec** 27 49

**Purpose** Sets the line spacing to 7/72 inch (10.3 lpi) for subsequent line feeds.

**Discussion** All lines are printed at the 7/72-inch line spacing until a new line spacing is selected or the printer is reset. This control code overrides line spacing set at the operator panel.  
Printing speed is reduced if printed lines overlap.

**Example** The following example illustrates 7/72-inch line spacing.

```
Control code ESC 1 sets
line spacing at
7/72 inch for all subsequent lines
until reset or another spacing is selected.
```

## Line Spacing $n/216$ Inch

**ASCII** ESC 3  $n$

**Hex** 1B 33  $n$

**Dec** 27 51  $n$

**Purpose** Specifies the line spacing at  $n/216$ -inch increments.

**where:**  $n = 0$  through 255

**Discussion** All line feeds following receipt of this code are at  $n/216$  inch line spacing until a new line spacing is selected or the printer is reset. Line spacing set by this control code overrides line spacing set at the operator panel.

The vertical character position moves only in multiples of the current dot row spacing. If the distance to move is other than a multiple of the current dot row spacing, the remainder is added to the next paper motion command.

Paper movement occurs in multiples of 3/216 only.

Use caution when combining this control code with other print attributes such as Elongated (Double High), Superscript, or Subscript; overlapping lines may occur. Print speed is reduced if lines overlap.

**Example** The following example illustrates  $n/216$ -inch line spacing.

```
Control code ESC 3 50 sets  
line spacing at 50/216 inch  
increments for all subsequent lines  
until reset or another spacing is selected.
```

### Line Spacing $n/72$ Inch

**ASCII** ESC A  $n$

**Hex** 1B 41  $n$

**Dec** 27 65  $n$

**Purpose** Sets a line spacing of  $n/72$  inch for subsequent line feeds.

**where:**  $n = 0$  through 255

**Discussion** When this control sequence is received, all subsequent line feeds are  $n/72$ -inch until a new line spacing is selected or the printer is reset. This setting overrides line spacing set at the operator panel.

Small values of  $n$  may result in overlapping lines. Overlapping lines may also occur if print attributes such as Elongated (Double High), Superscript, or Subscript characters are used on the same line. If lines overlap, printing speed is reduced. Any values set by ESC 3 (line spacing  $n/216$  inch) are replaced.

**Example** The following example illustrates  $20/72$ -inch line spacing.

```
Control code ESC A 20 sets  
line spacing at 20/72 inch  
increments for all subsequent lines  
until reset or another spacing is selected.
```

### Make Hex 80-9F Control Codes

**ASCII** ESC 7

**Hex** 1B 37

**Dec** 27 55

**Purpose** Selects hex codes 80-9F in the character sets as control codes.

**Discussion** This is the default when the Epson character set is selected as the default set at the operator panel.



## **Make Hex 80-9F Printable**

**ASCII**        ESC 6

**Hex**         1B 36

**Dec**         27 54

**Purpose**       Selects hex codes 80-9F in the character sets as printable characters.

**Discussion**   This is the default when the IBM PC character set (code page 0437) is selected as the default set at the operator panel.

Figure 2 shows the hex 80-9F printable characters for the Epson character set, and for the IBM PC graphic character set.

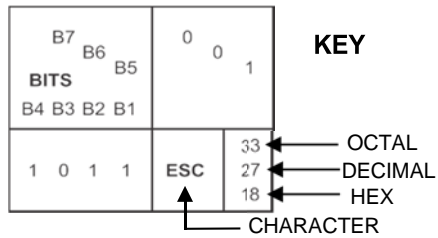

B8	B7	B6	BITS	B5	ROW	COLUMN			
						8	9		
0	0	0	0	0	0	à	200 128 80	§	220 144 90
0	0	0	1	1	1	è	201 129 81	β	221 145 91
0	0	1	0	2	2	ù	202 130 82	Æ	222 146 92
0	0	1	1	3	3	ò	203 131 83	æ	223 147 93
0	1	0	0	4	4	ì	204 132 84	∅	224 148 94
0	1	0	1	5	5	°	205 133 85	∅	225 149 95
0	1	1	0	6	6	£	206 134 86	¨	226 150 96
0	1	1	1	7	7	ï	207 135 87	Ä	227 151 97
1	0	0	0	8	8	é	210 136 88	Ö	230 152 98
1	0	0	1	9	9	ñ	211 137 89	Ü	231 153 99
1	0	1	0	10	10	ñ	212 138 8A	ä	232 154 9A
1	0	1	1	11	11	æ	213 139 8B	ö	233 155 9B
1	1	0	0	12	12	P <sub>t</sub>	214 140 8C	ü	234 156 9C
1	1	0	1	13	13	Å	215 141 8D	É	235 157 9D
1	1	1	0	14	14	å	216 142 8E	é	236 158 9E
1	1	1	1	15	15	ç	217 143 8F	¥	237 159 9F

Epson USA Character Set

B8	B7	B6	BITS	B5	ROW	COLUMN			
						8	9		
0	0	0	0	0	0	Ç	200 128 80	É	220 144 90
0	0	0	1	1	1	ü	201 129 81	æ	221 145 91
0	0	1	0	2	2	é	202 130 82	Æ	222 146 92
0	0	1	1	3	3	â	203 131 83	ô	223 147 93
0	1	0	0	4	4	ä	204 132 84	ö	224 148 94
0	1	0	1	5	5	à	205 133 85	ò	225 149 95
0	1	1	0	6	6	å	203 134 86	û	226 150 96
0	1	1	1	7	7	ç	207 135 87	ù	227 151 97
1	0	0	0	8	8	ê	210 136 88	ÿ	230 152 98
1	0	0	1	9	9	ë	211 137 89	ö	231 153 99
1	0	1	0	10	10	è	212 138 8A	Ü	232 154 9A
1	0	1	1	11	11	ï	213 139 8B	ç	233 155 9B
1	1	0	0	12	12	î	214 140 8C	£	234 156 9C
1	1	0	1	13	13	ì	215 141 8D	¥	235 157 9D
1	1	1	0	14	14	Ä	216 142 8E	P <sub>t</sub>	236 158 9E
1	1	1	1	15	15	Å	217 143 8F	f	237 159 9F

IBM 437 Code Page

Figure 2 Epson Printable Codes (Hex 80-9F)

## Master Print Select

**ASCII** ESC ! *n*

**Hex** 1B 21 *n*

**Dec** 27 33 *n*

**Purpose** Selects or changes print attributes in a single command.

**where:** *n* = an 8-bit number with the bits set to specify print attributes, as shown below.

**Table 20 Master Print Select**

Bit No.	Bit = 0	Bit = 1
0	1 cpi	† 12 cpi
1	Monospaced	† Proportional
2	Normal	Condensed
3	Normal	Emphasized
4	Normal	† Double Strike
5	Normal	Double Wide
6	Normal	Italic
7	Normal	Underlined

†**Discussion** Emphasized is substituted for double strike. Graphics and grey scale characters are not underlined. Proportional spacing overrides condensed or 12 cpi printing if both are selected.

## Paper Out Detection, Enable

**ASCII** ESC 9

**Hex** 1B 39

**Dec** 27 57

**Purpose** Asserts a paper out condition immediately when the end of the paper supply is sensed.

†**Discussion** The printer decodes and ignores this command.

## Paper Out Detection, Disable

**ASCII** ESC 8

**Hex** 1B 38

**Dec** 27 56

**Purpose** Enable printing to the end of the paper supply when a paper out condition is sensed.

†**Discussion** The printer decodes and ignores this command.

## Pass Bit 7 from Host

<b>ASCII</b>	ESC #
<b>Hex</b>	1B 23
<b>Dec</b>	27 35
<b>Purpose</b>	Passes bit 7 (the eighth and most significant bit) whether it is 1 or 0, thereby cancelling ESC > and ESC =.
<b>Discussion</b>	This command affects only text and control code data; bit 8 of graphics data is always passed through.

## Printer Select

<b>ASCII</b>	DC1
<b>Hex</b>	11
<b>Dec</b>	17
<b>Purpose</b>	Places printer in the selected state.
<b>Discussion</b>	The configuration parameter Printer Select must be set to Enable. Refer to the <i>Administrator's Manual</i> for information about this menu option. This control code allows the printer to receive and print data from the host if it was deselected by DC3. If the printer was not deselected by DC3, this code is ignored.

## Printer Deselect

<b>ASCII</b>	DC3
<b>Hex</b>	13
<b>Dec</b>	19
<b>Purpose</b>	Places printer in the deselected state.
<b>Discussion</b>	The configuration parameter Printer Select must be set to Enable. Refer to the <i>Administrator's Manual</i> for information about this menu option. When the printer receives this command it ignores data until a DC1 (Printer Select) command is received.

## Reassign Graphics Mode

<b>ASCII</b>	ESC ? <i>s m</i>
<b>Hex</b>	1B 3F <i>s m</i>
<b>Dec</b>	27 63 <i>s m</i>
<b>Purpose</b>	Changes one graphics mode to another.
<b>Discussion</b>	<i>s</i> is character K, L, Y, or Z, which is changed to mode <i>m</i> (0-7) from Table 21 on page 78. Thereafter, sending data to the bit image command makes the data print according to the graphics mode you select with <i>m</i> .

## Remove Downloaded Characters

<b>ASCII</b>	ESC : NUL <i>n</i> NUL
<b>Hex</b>	1B 3A 00 <i>n</i> 00
<b>Dec</b>	27 58 0 <i>n</i> 0
<b>Purpose</b>	Erases all downloaded characters.
<b>†Discussion</b>	The printer ignores this command but removes all data sent.

## Reverse Line Spacing $n/216$ Inch

<b>ASCII</b>	ESC j <i>n</i>
<b>Hex</b>	1B 6A <i>n</i>
<b>Dec</b>	27 106 <i>n</i>
<b>Purpose</b>	Specify the reverse line feed at $n/256$ -inch increment
<b>where</b>	$n = 0$ through 255

**Discussion** All reverse line feeds following receipt of this code are at  $n/216$  inch line spacing until a new line spacing is selected or the printer is reset. Line spacing set by this control code overrides line spacing set at the operator panel.

The vertical character position moves only in multiples of the current dot row spacing. If the distance to move is other than a multiple of the current dot row spacing, the remainder is added to the next paper motion command.

Paper movement occurs in multiples of  $3/216$  only.

Use caution when combining this control code with other print attributes such as Elongated (Double High), Superscript, or Subscript; overlapping lines may occur. Print speed is reduced if lines overlap.

## Select Graphics Mode

<b>ASCII</b>	ESC * <i>m n1 n2</i>
<b>Hex</b>	1B 2A <i>m n1 n2</i>
<b>Dec</b>	27 42 <i>m n1 n2</i>
<b>Purpose</b>	Turns on 8-pin bit image graphics mode <i>m</i> . Table 21 charts the graphics modes available.

**Discussion** The total number of columns =  $n1 + 256n2$ .

**NOTE:** This command does not suppress hexadecimal FF from printing.

**Table 21 Epson Graphics Modes**

<i>m</i>	Option	Alternate Code	Density* (dots per inch)	Resolution** (dots per inch)
0	Single density	ESC K	60	120
1	Double density	ESC L	120	120 <sup>1</sup>
2	High-speed double density	ESC Y	60	120 <sup>2</sup>
3	Quadruple density	ESC Z	120	240 <sup>1,2,3</sup>
4	CRT I	none	80	160
5	Plotter (1:1)	none	72	144
6	CRT II	none	90	180
7	Double density plotter	none	144	144 <sup>1</sup>

<sup>1</sup> Prints at half speed.  
<sup>2</sup> Data can be sent incorrectly. In these modes, no dots can be closer horizontally than the current font dot density. Sending incorrect data does not damage the printer.  
<sup>3</sup> 240 dpi is simulated by combining the dots from two adjacent columns into one 120 dpi dot column.  
\* Number of horizontal dots per inch the printer can make.  
\*\* Number of dot columns available.

### Select Italic Character Set

**ASCII**        ESC t *n*

**Hex**         1B 74 *n*

**Dec**         27 116 *n*

**Purpose**       Selects the italics characters from hex 80 through hex FF, or selects the graphics characters from hex 80 through hex FF.

**where:**      *n* = hex 1 selects the graphics character set

*n* = hex 0 selects the italics character set

**Discussion**    The graphics character set is the IBM Graphics Code Page 437.

## Select 9-Pin Graphics Mode

**ASCII** ESC ^ *m n1 n2 d1 ... dk*

**Hex** 1B 5E *m n1 n2 d1 ... dk*

**Dec** 27 94 *m n1 n2 d1 ... dk*

**Purpose** Turns on 9-pin bit image graphics mode.

**Discussion** *m* defines the plot density as shown in Table 21 on page 78.

$n1 + 256n2$  = The total number of columns.

This mode requires two bytes of graphic data for every column of print. Each column is sent as a pair: *d1, d3, ... d(k-1)* set the top 8 bits of a normal dot column, just like ESC K; *d2, d4, ... dk* set the ninth dot in the column (the most significant bit) just below the bottom-most dot of columns *d1, d3, ... d(k-1)*.

## Select Print Quality

**ASCII** ESC *x n*

**Hex** 1B 78 *n*

**Dec** 27 120 *n*

**Purpose** Selects print quality.

**where:** *n* may be in the range from 0 through 4. Values in the range 5-255 are invalid.

*n* = hex 0 or hex 30 selects DP print quality

*n* = hex 1 or hex 31 selects Near Letter Quality (NLQ)

*n* = hex 2 or hex 32 selects Draft print quality

*n* = hex 3 or hex 33 selects OCR A print quality

*n* = hex 4 or hex 34 selects OCR B print quality

**Discussion** This command overrides operator panel print quality selections.

**NOTE:** Some print attributes (such as condensed, double-wide, etc.) may not return to their previous setting when changing from OCR-A or OCR-B back to another Print Quality. For guaranteed results, all print attributes should be set after the Print Quality is selected.

† Selecting an OCR print quality overrides any character attributes set, such as condensed, double-wide, etc. Setting character attributes when OCR is set may cause unexpected results.

† Draft, OCR A, and OCR B print qualities (*n* = 2, 3, or 4) are not defined in Epson-FX printers.

## Select/Deselect Proportional Spacing

**ASCII** ESC *p n*

**Hex** 1B 70 *n*

**Dec** 27 112 *n*

**where:** *n* = 0 = Off; *n* = 1 = On

**Purpose** Turns proportional mode on and off.

### Select Serif or Sans Serif Font

<b>ASCII</b>	ESC k <i>n</i>
<b>Hex</b>	1B 6B <i>n</i>
<b>Dec</b>	27 107 <i>n</i>
<b>Purpose</b>	Selects an NLQ font.
<b>† where:</b>	if $n = 0, 2, 4 \dots$ (any even value), the font selected is a serif NLQ font (Courier, instead of standard Epson Roman). if $n = 1, 3, 5 \dots$ (any odd value), the font selected is a sans serif NLQ font.

### Select User-Defined Font

<b>ASCII</b>	ESC % <i>n</i>
<b>Hex</b>	1B 25 <i>n</i>
<b>Dec</b>	27 37 <i>n</i>
<b>Purpose</b>	Selects a user-defined font.
<b>†Discussion</b>	The printer ignores this command and removes all font data sent from the data stream.

### Select Vertical Tab Channel

<b>ASCII</b>	ESC / <i>c</i>
<b>Hex</b>	1B 2F <i>c</i>
<b>Dec</b>	27 47 <i>c</i>
<b>Purpose</b>	Selects a vertical tab channel set by ESC b.
<b>where:</b>	$c = 0$ through 7.
<b>Discussion</b>	Subsequent VT (hex 0B) commands use tab table specified by <i>c</i> . If no tab table is selected, channel 0 is used.

### Set Absolute Horizontal Print Position in 1/60 Inch

<b>ASCII</b>	ESC \$ <i>n1 n2</i>
<b>Hex</b>	1B 24 <i>n1 n2</i>
<b>Dec</b>	27 36 <i>n1 n2</i>
<b>Purpose</b>	Moves the logical print head to an absolute horizontal print position, using 1/60 inch increments.
<b>where:</b>	$\frac{(n1 + 256n2)}{60}$ = the unsigned distance in inches from the left margin.
<b>Discussion</b>	If the distance goes beyond right margin, the sequence is ignored.



## Set Bit 7 of Incoming Data Bytes to 1

**ASCII** ESC >

**Hex** 1B 3E

**Dec** 27 62

**Purpose** Sets the most significant bit (MSB) of all incoming data to 1.

**Discussion** The MSB is bit number 7. This command only affects text and control code data. Graphics data pass through unchanged.

## Set Relative Horizontal Print Position in 1/120 Inch

**ASCII** ESC \ *n1 n2*

**Hex** 1B 5C *n1 n2*

**Dec** 27 92 *n1 n2*

**Purpose** Moves the logical print head to a relative horizontal print position, using 1/120 inch increments.

**Discussion** Adds  $(n1 + 256n2)/120$  inches to the horizontal position of the logical print head. The number sent is two's complement, with negative numbers moving to the left. The command is ignored if it would move the logical print head beyond the page margins.

## Set Intercharacter Spacing in 1/120 Inch

**ASCII** ESC SP *n*

**Hex** 1B 20 *n*

**Dec** 27 32 *n*

**Purpose** Permits character spacing adjustments in 1/120 inch increments.

**where:** *n* = 0 through 127.

## Set Margin, Left

**ASCII** ESC | *n*

**Hex** 1B 6C *n*

**Dec** 27 108 *n*

**where:** *n* = number of columns from the left edge of the physical page to the beginning of the print line; *n* = 1 through 232 (hex 00 through E8).

**Purpose** Sets the left margin to *n* columns in the current font.

**Discussion** Be sure to use the alphabetic lowercase "l" (as in left) rather than the numeral "1" (one) for this command. The number of inches of margin does not vary if the font, character width, or horizontal dot density changes. This command automatically clears and resets horizontal tabs to every eight characters. The smallest possible space between the left and right margins is the width of one double-wide, 10 cpi character. If a margin control code violates this minimum distance, it is ignored. Settings in proportional mode are treated as 10 CPI.

## Set Margin, Right

**ASCII** ESC Q *n*

**Hex** 1B 51 *n*

**Dec** 27 81 *n*

**where:** *n* = number of columns from the left edge of the physical page to the end of the print line;  
*n* = 1 through 232 (hex 00 through E8).

**Purpose** Sets the right margin to *n* columns at the current character width.

**Discussion** The number of inches of margin does not vary if the font, character width, or horizontal dot density changes. This command automatically clears and resets horizontal tabs to every eight characters. The smallest possible space between the left and right margins is the width of one-double wide, 10 cpi character. If a margin control code violates this minimum distance, it is ignored. Settings in proportional mode are treated as 10 CPI.

## Set Forms Length by Lines

**ASCII** ESC C *n*

**Hex** 1B 43 *n*

**Dec** 27 67 *n*

**Purpose** Sets the form length by lines.

**where:** *n* = 1 through 192 (hex 01 through C0) to specify the number of lines per form at the current line spacing.

**Discussion** The forms length is set to the number of lines defined by the quotient of *n* divided by the current lines per inch so that the units are in inches.

The current line becomes the first line of the form. The forms length is always defined in inches; therefore, changing the lpi after this control code has been issued does not change the forms length.

If the calculated forms length in lines is not an exact multiple of the target machine dot size, the forms length value will be adjusted down to the next possible multiple.

When forms length is set by an ESC C sequence, the skip-over perforation set by ESC N is cancelled.

## Set Form Length in Inches

**ASCII** ESC C NUL *n*

**Hex** 1B 43 00 *n*

**Dec** 27 67 0 *n*

**Purpose** Sets form length to *n* inches.

**where:** *n* = 1 through 24 (hex 01 through 18) to specify the number of inches on a form.

**Discussion** Upon receipt of this code, the current line becomes the first line of the form, and the form length set becomes the current forms length. Vertical tab positions set below the bottom of the form are ignored. Forms length is defined in inches; therefore, subsequent line spacing changes do not affect the result of this command.

Values of *n* greater than 24 are ignored.

When forms length is set by an ESC C NUL sequence, the skip- over perforation set by ESC N is cancelled.

This control code overrides forms length set at the operator panel.

## Set Vertical Tabs in Channels

**ASCII** ESC b *c n1 n2 n3 ... n16* NUL

**Hex** 1B 62 *c n1 n2 n3 ... n16* 00

**Dec** 27 98 *c n1 n2 n3 ... n16* 0

**Purpose** Assigns vertical tabs to channels selected by ESC / (see page 80).

**where:** *c* = 0 through 7

*n* = 0 through 255

*n1* through *nk* specify the line number for the vertical tab(s), up to a maximum of 16 tab positions. NUL must end the sequence.

**Discussion** Channels are selected by ESC /. The distance of each tab stop from TOF is the current line spacing times the number of lines given in *n*.

If paper movement is commanded to a value of *n* greater than the page length, the paper movement command is ignored. The values of *n* must be in ascending order. If they are not, the sequence up to and including the out of sequence number is ignored. The rest of the load is processed. Skip over perforation is ignored.

You can clear any channel by sending ESC b *c* NUL, where *c* is the channel number.

## Skip Over Perforation

**ASCII** ESC N *n*

**Hex** 1B 4E *n*

**Dec** 27 78 *n*

**Purpose** Selects the number of lines (at the current line spacing) for the paper to skip at the bottom of the page.

**where:** *n* = 1 through 127 (hex 01 through 7F)

**Discussion** *n* is the number of lines skipped between the last line printed on one page and the first line on the next page. The actual distance set is the product of *n* and the current line spacing. If the value of *n* exceeds the current form length, the skip is set to one line smaller than the form length or to 0, whichever is greater.

Skip over perforation set by this command overrides operator panel settings. This feature is canceled by ESC O, ESC C, ESC C 0.

## Skip Over Perforation, Cancel

**ASCII** ESC O

**Hex** 1B 4F

**Dec** 27 79

**Purpose** Cancels the skip over perforation set by ESC N and resets the bottom margin to zero.

**Discussion** O is ASCII uppercase o, not zero (0).

## Superscript/Subscript Printing

**ASCII** ESC S *n*

**Hex** 1B 53 *n*

**Dec** 27 83 *n*

**Purpose** Selects superscript or subscript printing.

**where:** *n* = NUL (hex 00) or 0 (hex 30) to enable superscript printing

*n* = SOH (hex 01) or 1 (hex 31) to enable subscript printing

†**Discussion** Superscript prints full-sized characters with a baseline higher than the normal characters. Subscript prints full-sized characters with a baseline lower than the normal characters. When the control code is received, all characters are superscript or subscript until reset by ESC T or printer reset. (This differs from the Epson standard, which utilizes half-size characters for superscript and subscript printing.)

You can print both superscript and subscript characters in the same character column by using the Backspace (BS) control code, but these characters will not print when double high printing is in effect.

If Superscript/Subscript is combined with Double High (ESC w) printing, *only* Double High printing will occur.

**Example** The following sample output illustrates superscript and subscript printing.

```
CONTROL CODE ESC S 0 SELECTSSUPERSCRIP  
A2+B2=C2  
CONTROL CODE ESC S 1 SELECTSSUBSCRIPT  
31HEX=49DEC  
CONTROL CODE ESC T CANCELS  
SUPERSCRIPT/SUBSCRIPT PRINTING
```

### Superscript/Subscript Printing, Cancel

<b>ASCII</b>	ESC T
<b>Hex</b>	1B 54
<b>Dec</b>	27 84
<b>Purpose</b>	Cancels superscript and/or subscript printing as set by ESC S <i>n</i> .

### Super-Set Commands

<b>ASCII</b>	ESC   } ;
<b>HEX</b>	1B 7C 7D 3B
<b>Dec</b>	27 124 125 59
<b>Purpose</b>	Control code sequence used to introduce the super-set commands.
<b>Discussion</b>	The “ ” in the command string is the pipe symbol.
<b>Comment</b>	Super-set commands affect the LinePrinter Plus emulation as a whole regardless of the printer protocol currently active. The commands are sent through the host in the input data stream, and enact the following features:

- Select a printer protocol
- Bar codes
- Set variable character spacing
- Set variable line spacing

Refer to Chapter 7, Super-Set Programming, for further information regarding the super-set commands.

### Underline

<b>ASCII</b>	ESC – <i>n</i>
<b>Hex</b>	1B 2D <i>n</i>
<b>Dec</b>	27 45 <i>n</i>
<b>Purpose</b>	Turns automatic underlining on and off.
<b>where:</b>	<i>n</i> = NUL or 0 (hex 00 or 30) to turn off underlining <i>n</i> = SOH or 1 (hex 01 or 31) to turn on underlining
<b>Discussion</b>	Spaces are underlined, but graphics and grey scale characters are not.

**Example** The following sample output illustrates underlining.

```
Control code ESC -1
enables automatic underlining.
Control code ESC -0
disables automatic underlining.
```

### Unidirectional Printing, 1 Line

**ASCII** ESC <

**Hex** 1B 3C

**Dec** 27 60

**Purpose** Causes printing to occur from left to right for one line only.

**Discussion** Printing normally occurs in both directions of shuttle movement. This command causes the printer to print from left to right for one line. The command is cancelled by a CR.

### Unidirectional Printing, Set/Reset

**ASCII** ESC U *n*

**Hex** 1B 55 *n*

**Dec** 27 85 *n*

**Purpose** Causes printing to occur in only one direction of shuttle movement (left to right).

**where:** *n* = NUL or 0 (hex 00 or 30) turns unidirectional mode off  
*n* = SOH or 1 (hex 01 or 31) turns unidirectional mode on

**Discussion** Printing normally occurs in both directions of shuttle movement.

Unidirectional printing slows the printer down approximately 50%, but is sometimes used when very accurate dot placement is desired in graphics.

### Vertical Tab, Execute

**ASCII** VT

**Hex** 0B

**Dec** 11

**Purpose** Advances the logical print head to the next vertical tab position selected by ESC /.

**Discussion** If no vertical channel was selected, channel 0 is used. If no vertical tabs were set, the paper advances one line.

The logical print head moves to the left margin. If a tab position is on the current line, the paper is moved to the next tab position. If there are no tab positions between the current line and the end of the form, the paper is moved to the top of the next form.

This code cancels all one-line-only emphasis and font controls: double-wide from SO and ESC SO, and unidirectional printing from ESC <.

## Vertical Tab, Set/Clear

**ASCII** ESC B *n1 n2 n3...nk* NUL

**Hex** 1B 42 *n1 n2 n3...nk* 00

**Dec** 27 66 *n1 n2 n3...nk* 0

**Purpose** Sets up to 16 vertical tab positions.

**where:** *n* = 1 through 255

*k* = 1 through 16

*n1* through *nk* specify the line numbers for the vertical tab(s), up to a maximum of 16 tab positions. NUL must end the sequence.

To clear the tab settings, send ESC B NUL (hex 1B 42 00).

**Discussion** The values of *n* range from 1 through 255 and must be in ascending order. The distance of each tab stop from TOF is the current line spacing times the number of lines given in *n*. If the value of *n* exceeds the form length, commands to move to that tab position are ignored.

If values of *n* are not in ascending order, the sequence up to and including the out-of-sequence number is ignored, and the rest of the load is processed. Skip over perforation is ignored.

This command always sets channel 0. You can clear channel 0 by sending ESC B NUL. (See also the channel selection command, ESC /, and the channel loading command, ESC b.)





# 4 *P-Series Printer Emulation*

## Overview

This chapter describes the P-Series emulation host control codes. “Emulation” refers to the ability of a printer to execute the commands of a particular printer control language. A printer control language is the coding system used to convey, manipulate, and print data. It contains character codes and command sequences that configure the emulation. In this manual, the terms emulation, printer protocol, and printer control language are synonymous.

In the P-Series emulation mode, your printer can print files coded for the P-Series printer control language. To select the P-Series emulation mode as the active printer emulation, select LinePrinter+ from the EMULATION menu and P-Series from the Printer Protocol menu, as described in the *Administrator's Manual*.

The P-Series emulation provides many configurable parameters. The default parameter values for this emulation are shown in Table 22. You can modify the emulation parameter values in two ways:

- **The P-Series host control codes.** An extensive set of P-Series control code commands can be sent to the printer from an attached host computer via the host data stream. Most of this chapter is devoted to describing the P-Series control code commands.
- The printer configuration menus. You can modify a subset of the P-Series emulation parameters using the printer configuration menus, control panel keys and LCD, as described in the *Administrator's Manual*.

A parameter value set by a host control code generally overrides a value set from the printer's control panel.

Configuration values selected from the menus or via host control codes can be saved to the printer's NVRAM memory so that they will not be lost when you power off the printer or reset it to the factory defaults. The menu selection for saving a configuration to memory is described in the *Administrator's Manual*. Refer to Appendix B, PTX\_SETUP Commands to save the configuration using host control codes.

## P-Series Default Values and States

Your printer memory stores a set of typical operating states and conditions for the P-Series emulation. When you power on the printer and select this emulation, the default settings in Table 22 are automatically invoked.

**Table 22 P-Series Default Settings**

<b>Characteristic</b>	<b>Default Setting</b>
Character Sets	IBM PC
Print Language	ASCII (USA)
IBM PC	
Select Subset Primary	ASCII (USA)
Select Subset Extended	0437 PC Character Set
Multinational	ASCII (USA)
ECMA Latin 1	
Select Subset Primary	ASCII (USA)
Select Subset Extended	Multinational
DEC Multinational	ASCII (USA)
Control Code 06	8.0 LPI
Control Code 08	Elongated
Define CR Code	CR = CR
Auto LF	Disable
Overstrike	Enable
Define LF Code	LF = CR + LF
Select SFCC	1
EVFU Selected	Enable
Alternate Set 80-9F	Control Code

Table 23 lists several additional default settings for parameters that are provided by the Print Format menus (described in the *Administrator's Manual*). Many of the settings shown in Table 23 can be overridden by P-Series host control codes for the same parameter.

**Table 23 P-Series Default Settings**

Characteristic	Default Settings
CPI	10.0
LPI	6.0
Forms Width	13.6 inches 345.4 millimeters 136 characters
Forms Length	11.0 inches 279 millimeters 66 lines
Print Quality	DP Quality
Proportional Spacing	Disable
Italic Print	Disable
Slashed Zero	Disable
Left Margin	0 columns
Right Margin	0 columns
Bottom Margin	0 lines
Perforation Skip	Disable

## Configuring the P-Series Emulation with Control Codes

The remainder of this chapter describes the P-Series printer control language codes that may be sent from a host computer attached to the printer, in order to invoke and configure numerous P-Series emulation functions.

### Format for Control Code Descriptions

The following information is listed for each code function (where applicable).

- Name** The title or function of the command.
- ASCII** The ASCII mnemonic for the command is shown. Command sequences are in 7-bit (ASCII) form.
- Hex** The code or command sequence in hexadecimal numbers.
- Dec** The code or command sequence in decimal numbers.
- Purpose** The function(s) of the control code.
- Discussion** A discussion of the uses of the code or command sequence, including exceptions or limitations to its use.

**Example** A sample output is provided for some control codes when it is possible to illustrate the effect of a control code, or if a specific syntax is required to complete the program statement (i.e., Horizontal Tab set, Vertical Tab set/clear).

**IMPORTANT** If you specify any parameters for a control code other than those defined in the control code description, unpredictable results may occur.

### Special Function Control Code (SFCC) Header

A Special Function Control Code (SFCC) is used to extend the control code protocol. The SFCC is the control code introducer (or header); it is the first input in the sequence of parameters. The general control code sequence is:

(SFCC)(parameter 1)(parameter 2)...(parameter *n*)

The P-Series SFCC can be configured to be any of the following decimal values: 1, 3, 9, and 16 through 127 (hex 01, hex 03, hex 09, and hex 10 through hex 7F). For example, bold print could be configured to be enabled in the P-Series protocol using any of the control code introducers listed in Table 24.

**Table 24 SFCC Example (Bold Print)**

ASCII	Hex	Decimal
SOH G	01 47	1 71
ETX G	03 47	3 71
ESC G	1B 47	27 71
^ G	5E 47	94 71
~ G	7E 47	126 71

**NOTE:** The SFCC has been set to ESC for all examples.

You must select the SFCC by changing the value of the “Select SFCC” parameter in the P-Series emulation menu on the printer front panel. The default value is 1. See your *Administrator’s Manual* for details.

### SFCC Command Line

Print format, print mode, or international language selection can be controlled by a longer sequence known as a command line. Command lines are string type commands placed between complete lines of text and affect the text which follows. The protocol has six command lines: PMODE, OSET, PSET, LPI, LINES, and INCHES. Each of these command lines is discussed in this chapter under the appropriate Control Code function.

For example, the forms length (in inches) can be set using the following command line:

SFCC INCHES;*n.f*

**where:** *n* is the whole number of inches, and *f* is the fractional increment in 0.5 inch increments.

When using the SFCC in a command line, the SFCC must be the first non-blank symbol in the line (space, hex 20, is a blank symbol). In addition, characters following spaces (other than a valid line terminator) in a command line are ignored so that user comments can be included on the command line. The valid line terminators are Form Feed (FF), Line Feed (LF), and Carriage Return (CR); however, when used in the command line, these line terminators do *not* cause any paper motion. If a command line contains an error, the command will not be executed.

### Attribute Set and Reset Codes

Certain print attributes are set and reset (turned on or off) by using the appropriate SFCC code sequence and the numbers 1 or 0. These may be either the hexadecimal code 01 and 00, or the ASCII code for the

printable symbols of decimal 1 and 0 (hexadecimal code 31 and 30, respectively). Expanded Print, Super/Subscript Print, and Underline are attributes that are set/reset this way.

### NUL Code

NUL (Hex 00) is ignored by the printer and can be used as a fill character; however, it can not be used to add blank spaces since it is not a space character.

**NOTE:** Hex 80 in the 0437 PC Character Set and Hex 7F in the 0850 PC Character Set are treated as a NUL; however, these two controls can not be used as parameter terminators.

### Print Modes Supported for Character Sets

Table 25 presents a summary of which print modes are supported for the P- Series emulation character sets. Additional information about character set support is provided under the heading "Notes."

**Table 25 Character Set Print Mode Support**

Character Set	NLQ(Serif)/DP/Draft	Notes
IBM PC, Primary Subset ASCII (USA) French German English (UK) Danish Swedish Italian Spanish Japanese French Canadian Latin American Danish II Spanish II Latin American II	X	The print mode support is the same for all of the IBM PC Primary Subset languages.
IBM PC, Extended Subset 0437 IBM PC 0850 PC Multilingual		The print mode support is the same for both Extended character sets
Multinational ASCII (USA)	X	
Multinational EBCDIC	X	
ECMA Latin I, Primary Subset ASCII (USA) German Swedish Danish Norwegian Finnish English (UK) Dutch French Spanish Italian Turkish Japanese	X	The print mode support is the same for all of the ECMA Latin I Primary Subset languages.

**Table 25 Character Set Print Mode Support**

<b>Character Set</b>	<b>NLQ(Serif)/DP/Draft</b>	<b>Notes</b>
ECMA Latin I, Extended Subset Multinational Barcode 10 CPI Multinational NLQ 10 CPI Greek NLQ 10 CPI Graphic NLQ 10 CPI Scientific NLQ 10 CPI	X	
DEC Multinational ASCII (USA) French German English (UK) Norwegian/Danish Swedish Italian Spanish Japanese French Canadian Dutch Finnish Swiss	X	
ECMA Latin I, Extended Subset Barcode 10 CPI Multinational DP 10 CPI Multinational DP 12 CPI Multinational NLQ 10 CPI Greek DP 10 CPI Greek DP 12 CPI Greek NLQ 10 CPI Graphic DP 10 CPI Graphic NLQ 10 CPI Scientific DP 10 CPI Scientific DP 12 CPI Scientific NLQ 10 CPI	N/A	These character sets are guaranteed readable only in the Print Quality and Print Density specified.
DEC Multinational French German English (UK) Norwegian / Danish Swedish Italian Spanish Japanese French Canadian Dutch Finnish Swiss	X	The print mode support is the same for all of the DEC Multinational languages.
OCR-A / OCR-B	N/A	Only 10 cpi OCR is supported.

## The Control Codes

This index lists each printer command by function, ASCII mnemonic, and the page where the command is explained in detail. "N/A" means not applicable. The rest of this chapter defines the control code functions for P-Series Emulation mode. The commands are listed in alphabetical order.

**NOTE:** Some control code functions can be accomplished using another control code sequence or via operator panel selection.

<b>FUNCTION</b>	<b>ASCII CODE</b>	<b>PAGE</b>
<b>Paper Motion</b>		
Form Feed	FF	108
Line Feed	LF	110
Reverse	SFCC } ; <i>n</i>	117
Vertical Tab	VT	120
<b>Page Format</b>		
Backspace	BS	97
Carriage Return	CR	98
Forms Length Set (Inches)	SFCC INCHES; <i>n.f</i>	109
Forms Length Set (Lines)	SFCC LINES; <i>n</i>	109
Line Spacing 1/6 Inch (6 lpi)	SFCC 2 SFCC LPI; <i>n</i>	110
Line Spacing 1/8 Inch (8 lpi)	SFCC 0 SFCC LPI; <i>n</i>	111
Line Spacing 8 or 10.3 LPI (1 line only)	ACK SFCC f	111
Line Spacing 7/72 Inch	SFCC 1	112
Line Spacing <i>n</i> /72 Inch	SFCC A <i>n</i>	112
Line Spacing <i>n</i> /216 Inch	SFCC 3 <i>n</i>	113
VFU Commands (P-Series)	N/A	120
<b>Print Attributes</b>		
Bold Print	SFCC G	
Bold Print (1 line only)	SFCC j	97
Bold Print Reset	SFCC H	98
Elongated (Double High) Print, 1 Line Only	SFCC h	104
Elongated (Double High) Print Set/Reset	SFCC w <i>n</i>	105
Emphasized Print	SFCC E	105
Emphasized Print Reset	SFCC F	106
Expanded Print (Double Wide)	SFCC W <i>n</i>	106
Expanded Print (Double Wide) 1 line only	SFCC k	107
Overscoring	SFCC _ <i>n</i>	113
Print Mode/Pitch Selection	SFCC X <i>m n</i> SFCC PMODE; <i>n</i> SFCC [ <i>n q</i>	114

<b>FUNCTION</b>	<b>ASCII CODE</b>	<b>PAGE</b>
<b>Print Attributes (Continued)</b>		
Select Attributes	SFCC [ @ <i>n1</i> NUL NUL NUL <i>n2 n3</i>	117
Superscript/Subscript Printing	SFCC S <i>n</i>	118
Superscript/Subscript Printing Reset	SFCC T	119
Underline	SFCC – <i>n</i>	119
<b>Graphics</b>		
Plot, Even Dot (High Density)	EOT SFCC d	114
Plot, Odd Dot (Normal Density)	ENQ SFCC e	114
<b>Other Functions</b>		
Bell	BEL	97
Character Set Select	SFCC l <i>xyz</i>	99
Characters 80-9F (Control Codes)	SFCC 7	101
Characters 80-9F (Printable Symbols)	SFCC 6	101
Character Set Select: ECMA 94 Latin 1 Extended	SFCC OSET; <i>n</i>	101
Character Set Select: International Languages	SFCC R <i>n</i> SFCC PSET; <i>n</i>	103
Extended Character Set	SO SFCC SO SFCC <i>n</i> SFCC 4	107
Extended Character Set Cancel (Primary Set Select)	SI SFCC SI SFCC o SFCC 5	108
Emulation Reset	SFCC @	106
Super-Set Commands	SFCC   } ;	119



## Backspace

**ASCII** BS

**Hex** 08

**Dec** 08

**Purpose** Moves the logical print head to the left one character space toward the first character column.

**Discussion** When configured from the operator panel for backspace, BS moves the character position indicator (the logical print head position) one character space to the left at the current character pitch setting. The code is ignored if the logical print head is positioned at the first character column.

**Example** If you were to print five "T" characters, then two BS commands, then two "=" characters, the output would look like the sample below:

```
TTT##
```

## Bell

**ASCII** BEL

**Hex** 07

**Dec** 07

**Purpose** Sounds the printer buzzer/beeper.

**Discussion** The BEL function will sound the buzzer/beeper for 0.2 seconds upon receipt of this command.

## Bold Print

**ASCII** SFCC G SFCC j

**Hex** SFCC 47 SFCC 6A

**Dec** SFCC 71 SFCC 106

**Purpose** Selects bold character printing.

**Discussion** When the bold character printing control code is received, all characters are printed in bold until reset by the bold print reset control code or printer reset. Bold Print is the same as printing double strike.

When SFCC j is used, bold printing is selected for one line only and reset by the bold print reset control code, emulation reset, or a paper motion command.

**Example** The following sample output illustrates bold character printing.

```
Control code ESC G
selects bold character printing,
for example: AaBbCcDdEeFfGgHhIiJjKkLlMmNnOoPp.
Control code ESC H
cancels bold character printing.
```

## Bold Print Reset

<b>ASCII</b>	SFCC H
<b>Hex</b>	SFCC 48
<b>Dec</b>	SFCC 72
<b>Purpose</b>	Resets bold character printing.
<b>Discussion</b>	The Bold Print Reset control code only resets the bold print character attribute. Other print attributes such as double wide printing are not affected.
<b>Example</b>	Refer to the Bold Print control code for a sample output of bold character print set and reset.

## Carriage Return

<b>ASCII</b>	CR
<b>Hex</b>	0D
<b>Dec</b>	13
<b>Purpose</b>	Returns the logical print head to the first character column (resets the pointer to the first character position).
<b>Discussion</b>	<p>The CR code may or may not cause printing or paper motion, depending on the Define CR Code value defined in the configuration menus. If the Define CR Code submenu displays:</p> <p>Define CR Code CR = CR</p> <p>The characters following the CR are printed over the previous characters on the line. If identical characters are placed in the same position on the line, those characters will be printed in bold (double strike) print when the Overstrike mode is enabled from the operator panel.</p> <p>The CR=CR configuration causes subsequent printable data to overprint previous data at half speed if Overstrike is enabled from the operator panel (and prints somewhat faster if Overstrike is disabled), unless an intervening paper motion command is received.</p> <p>If the Define CR Code submenu displays:</p> <p>Define CR code CR = CR+LF</p> <p>Control code CR is converted to perform a carriage return and line feed function.</p>

## Character Set Select

**ASCII** SFCC I xyz (lowercase L)

**Hex** SFCC 6C xyz

**Dec** SFCC 108 xyz

**Purpose** Selects the character set, extended character set, and the international language for a specific character set.

**where:** x is the character set (Table 26);

y is the international language for the selected character set (Table 27);

z is the extended character set for the selected character set (Table 28);

**Discussion** An asterisk (\*) (hex 2A) may be substituted for x, y, or z. If the asterisk (\*) is the value selected for x, the character set will not change. If \* is the value selected for y or z, the previously selected international language and/or extended character set for the selected character set will be used.

If "x" is the value selected for y, the primary language will access the downloaded character substitution table defined by SFCC V for the selected character set.

The character set, international language and extended character set can also be selected from the printer operator panel, via the Character Set and Print Language options; however, the control code setting will override the operator panel selection. Except for the asterisk and X values discussed above, values other than those shown in the tables will result in the control sequence being terminated.

Table 25 on page 93 provides detailed notes on print mode support for each character set.

**Table 26 Character Set Select**

<b>x</b>	<b>Character Set</b>
0(03)	IBM PC
1(31)	Multinational
2(32)	ECMA 94 Latin 1
3(33)	DEC Multinational

**Table 27 International Language Select (y)**

<b>y</b>	<b>x = 0 (hex 30)</b>	<b>x = 1 (hex 31)</b>	<b>x = 2 (hex 32)</b>	<b>x = 3 (hex 33)</b>
	<b>IBM PC</b>	<b>Multinational</b>	<b>ECMA Latin 1</b>	<b>DEC Multinational</b>
0 (hex 30)	ASCII (USA)	ASCII (USA)	ASCII (USA)	ASCII (USA)
1 (hex 31)	French	EBCDIC	German	French
2 (hex 32)	German		Swedish	German
3 (hex 33)	English (UK)		Danish	English (UK)
4 (hex 34)	Danish		Norwegian	Norwegian/Danish
5 (hex 35)	Swedish		Finnish	Swedish
6 (hex 36)	Italian		English (UK)	Italian
7 (hex 37)	Spanish		Dutch	Spanish
8 (hex 38)	Japanese		French	Japanese
9 (hex 39)	French Canadian		Spanish	French Canadian
10 (hex 3A)	Latin American		Italian	Dutch
11 (hex 3B)	Norwegian		Turkish	Finnish
12 (hex 3C)	Danish-II		Japanese	Swiss
13 (hex 3D)	Spanish-II			
14 (hex 3E)	Latin American-II			

**Table 28 International Language Select (z)**

<b>z</b>	<b>x = 0 (hex 30)</b>	<b>x = 1 (hex 31)</b>	<b>x = 2 (hex 32)</b>	<b>x = 3 (hex 33)</b>
	<b>IBM PC</b>	<b>Multinational</b>	<b>ECMA Latin 1</b>	<b>DEC Multinational</b>
0 (hex 30)	IBM PC (0437)	Mult. Extended Set	Barcode 10 cpi	DEC Mult. Ext. Set
1 (hex 31)	IBM PC (0850)		Mult. DP 10 cpi	
2 (hex 32)			Mult. DP 12 cpi	
3 (hex 33)			Mult. NLQ 10 cpi	
4 (hex 34)			Greek DP 10 cpi	
5 (hex 35)			Greek DP 12 cpi	
6 (hex 36)			Greek NLQ 10 cpi	
7 (hex 37)			Graphics DP 10 cpi	
8 (hex 38)			Graphics NLQ 10 cpi	
9 (hex 39)			Scientific DP 10 cpi	
10 (hex 3A)			Scientific DP 12 cpi	
11 (hex 3B)			Scientific NLQ 10 cpi	
12 (hex 3C)			Multinational (at Primary set mode and pitch)	

### Characters 80-9F (Control Codes)

<b>ASCII</b>	SFCC 7
<b>Hex</b>	SFCC 37
<b>Dec</b>	SFCC 55
<b>Purpose</b>	Selects hex codes 80 through 9F in the character sets as control codes. Cancels the command SFCC 6.
<b>Discussion</b>	This control code overrides the operator panel setting (described in the <i>Administrator's Manual</i> ).

### Characters 80-9F (Printable Symbols)

<b>ASCII</b>	SFCC 6
<b>Hex</b>	SFCC 36
<b>Dec</b>	SFCC 54
<b>Purpose</b>	Selects hex codes 80 through 9F in the character sets as printable symbols. Cancels the command SFCC 7.
<b>Discussion</b>	This control code overrides the operator panel setting (described in the <i>Administrator's Manual</i> ).

### Character Set Select: ECMA 94 Latin 1 Extended

<b>ASCII</b>	SFCC OSET; <i>n</i>
<b>Purpose</b>	Selects the print mode and pitch at which the extended characters will print. Valid only if the ECMA 94 Latin 1 Extended Character Set is selected; otherwise, this command is ignored.
<b>Discussion</b>	<p><i>n</i> ranges from 0 through 12 to select the print mode/pitch combinations available from Table 29. All other values will result in an error message.</p> <p>Extended characters will print at the print mode and pitch selected by the OSET command, even if that mode and pitch differs from the currently selected print mode and pitch. If the print mode differs between the extended and primary characters, the first character in the data stream selects the print mode at which that line will print. Different pitches can be printed on the same line.</p>

**Table 29 Print Modes/Pitches Available Using P-Series OSET  
(ECMA Latin 1, Extended Character Set Only)**

<i>n</i>	Print Mode/Pitch Select
0	Barcode DP 10 cpi
1	Multinational DP 10 cpi
2	Multinational DP 12 cpi
3	Multinational NLQ 10 cpi
4	Greek DP 10 cpi
5	Greek DP 12 cpi
6	Greek NLQ 10 cpi
7	Graphics DP 10 cpi
8	Graphics NLQ 10 cpi
9	Scientific DP 10 cpi
10	Scientific DP 12 cpi
11	Scientific NLQ 10 cpi
12	Multinational at Primary Character Set Mode and Pitch

## Character Set Select: International Languages

**ASCII** SFCC PSET;*n* SFCC R *n*

**Hex** SFCC 52 *n*

**Dec** SFCC 82 *n*

**Purpose** Specifies the international language set identified by *n* in the basic character set selected from the operator panel (ECMA-94 Latin 1, IBM PC, Multinational, and DEC Multinational).

**where:** *n* specifies a language, as shown in Table 30.

**Table 30 International Character Sets**

<i>n</i>		Character Set Selected			
SFCC R (hex)	PSET	ECMA Latin 1	IBM PC (0437 or 0850)	Multinational	DEC Multinational
0 (30)	0	ASCII (USA)	ASCII (USA)	ASCII (USA)	ASCII (USA)
1 (31)	1	German	French	EBCDIC	French
2 (32)	2	Swedish	German		German
3 (33)	3	Danish	English		English (UK)
4 (34)	4	Norwegian	Danish		Norw./Danish
5 (35)	5	Finnish	Swedish		Swedish
6 (36)	6	English	Italian		Italian
7 (37)	7	Dutch	Spanish		Spanish
8 (38)	8	French	Japanese		Japanese
9 (39)	9	Spanish	French Canadian		French Canadian
0A (3A)	10	Italian	Latin American		Dutch
0B (3B)	11	Turkish	Norwegian (3B)		Finnish
0C (3C)	12	Japanese	Danish-II (3C)		Swiss
0D (3D)	13		Spanish-II (3D)		
			Latin AmII (3E)		
			Danish-II		
			Spanish-II		
			Latin II		
0E (3E)	14				
0F (3F)	15				
10 (40)	16				
11 (41)	17				
12 (42)	18				
13 (43)	19				
14 (44)	20				
15 (45)	21				
			<b>(currently undefined)</b>		

**Discussion** The international character set can also be selected from the operator panel via the Print Language option; however, the control code setting will override the operator panel character set selection. Values other than those selectable from Table 30 will be ignored.

Table 25 provides information on print mode support for each character set.

**Example** The following example illustrates international character selection using the IBM PC character set.

```
Control code ESC R 5 selects
the Swedish character set shown beneath
the USA (ASCII) characters.
```

```
A B C D [ \ ] ^ _ ` { | } ~
A B C D Ä Ö Å Ü - é ä ö à ü
```

### Elongated (Double High) Print, 1 Line Only

**ASCII** SFCC h BS

**Hex** SFCC 68 08

**Dec** SFCC 104 08

**Purpose** Selects elongated (double high) character printing for one line only. Elongated characters are approximately double height but standard width.

**Discussion** The elongated character control code is a line-by-line print attribute; when the control code is received, one entire line of elongated characters is printed and then automatically reset.

When configured for double high print, the P-Series control code BS (Hex 08) also selects elongated character printing for a single line.

When using this feature with relative line slewing, the paper will be moved  $n + 1$  lines rather than  $n$  lines. Refer to Chapter 9 for more information on relative line slewing. When using small line spacing and the lines overlap, an unexpected print format may result.

**Example** The following sample output illustrates elongated character printing.

```
Control code
ESC h selects
elongated character printing
for one line only.
```



## Elongated (Double High) Print, Set/Reset

**ASCII Code** SFCC w n

**Hex Code** SFCC 77 n

**Dec Code** SFCC 119 n

**Purpose** Turns double-high character printing on and off. Double-high characters are standard width but twice as high.

**where:** n = 1 or 49 (hex 01 or hex 31) turns double high printing on  
n = 0 or 48 (hex 00 or hex 30) turns double high printing off

**Discussion** The OCR A and OCR B fonts cannot be printed in double high.

**NOTE:** It is recommended to use double Line Feeds and Carriage Returns when double-high character printing is on (after an SFCC w control code has been sent), or else the printer will overstrike text that has already printed.

If Superscript/Subscript (SFCC S) is combined with Double High printing, *only* Double High printing will occur.

**Example** The following output illustrates double-high character printing.

```
Control Code ESC w
Selects Double High printing.
Cancels Double High printing.
```

## Emphasized Print

**ASCII** SFCC E

**Hex** SFCC 45

**Dec** SFCC 69

**Purpose** Selects emphasized character print format.

**Discussion** When the emphasized print control code is received, all characters will be printed in emphasized print until reset by the emphasized print reset control code or printer reset. The emphasized print attribute is implemented by horizontal "shadow" printing.

Emphasized print is ignored during superscript or subscript printing, and when 15-20 cpi characters have been selected.

**Example** The following sample output illustrates emphasized character printing.

```
Control code
ESC E selects
emphasized character printing.
Control code ESC F
cancels emphasized character printing.
```

## Emphasized Print Reset

<b>ASCII</b>	SFCC F
<b>Hex</b>	SFCC 46
<b>Dec</b>	SFCC 70
<b>Purpose</b>	Resets emphasized character printing.
<b>Discussion</b>	The emphasized print reset control code only resets the emphasized print character attribute.
<b>Example</b>	See the Emphasized Print control code example for an example of Emphasized Print Reset.

## Emulation Reset

<b>ASCII</b>	SFCC @
<b>Hex</b>	SFCC 40
<b>Dec</b>	SFCC 64
<b>Purpose</b>	Initializes all print mode related parameters to the factory default or power-up configuration values.
<b>Discussion</b>	<p>Print mode, line spacing, international language selection, margins, form length, skip-over perforation, and character pitch are reset to the selected power-up configuration. Character-by-character and line-by-line attributes are canceled. The vertical format unit is cleared. The current line is set to the top-of-form position. Interface parameters and printer protocol selection are not affected.</p> <p>If the menu option “Reset Cmd CFG Ld” is disabled, the factory default configuration is loaded. If it is enabled, the power-up configuration is used. The default is the factory default.</p>

## Expanded Print (Double Wide)

<b>ASCII</b>	SFCC W <i>n</i>
<b>Hex</b>	SFCC 57 <i>n</i>
<b>Dec</b>	SFCC 87 <i>n</i>
<b>Purpose</b>	Selects or resets expanded (double wide) print.
<b>where:</b>	<i>n</i> = 1 selects expanded print (hex 01 or hex 31) <i>n</i> = 0 resets expanded print (hex 00 or hex 30)
<b>Discussion</b>	When expanded print using SFCC W is received, all characters will be printed double wide until reset by the expanded print reset control code or a printer reset.

**Example** The following sample output illustrates expanded character printing and expanded character printing reset.

```
Control code
ESC W 1 selects
expanded character printing.
Control code
ESC W 0 resets
expanded character printing.
```

### Expanded Print (Double Wide), 1 Line Only

**ASCII** SFCC k

**Hex** SFCC 6B

**Dec** SFCC 107

**Purpose** Selects expanded (double wide) print for one line only.

**Discussion** This expanded print control code is a line-by-line print attribute; when the SFCC k control code is received, the current line is printed double wide and then automatically reset.

This control code can be reset by a paper motion control code (LF, VT, CR, etc.), SFCC @ (printer reset), CAN or SFCC W (double wide print).

**Example** The following sample output illustrates Expanded Print for one line only. Another example of expanded printing is shown for Expanded (Double Wide) Print, SFCC W on page 106.

```
Control code
SO selects
expanded character printing
for one line only.
```

### Extended Character Set

**ASCII** SO SFCC SO SFCC n SFCC 4

**Hex** 0E SFCC 0E SFCC 6E SFCC 34

**Dec** 14 SFCC 14 SFCC 110 SFCC 52

**Purpose** Accesses the extended character set in the range hex A0 through FF using codes hex 20 through 7F.

**Discussion** Used in 7-bit systems as if data bit 8 was set to 1. For example, sending code hex 20 accesses the symbol at code point hex A0. If a printable symbol is not available at the code point, a space is printed.

SFCC 4 is not cancelled by the next paper motion command; SO, SFCC SO, SFCC n are cancelled by paper motion.

**Example** The following sample output illustrates the Extended Character Set and Extended Character Set Cancel (see page 108) control codes.

```
Control code
ESC 4 selects the extended character set
and ESC 5 selects the primary character set
which is displayed beneath the extended character set.
```

```
ТтТТFfEe
ABCEDEFGH
```

### Extended Character Set Cancel (Primary Set Select)

<b>ASCII</b>	SI	SFCC SI	SFCC o	SFCC 5
<b>Hex</b>	0F	SFCC 0F	SFCC 6F	SFCC 35
<b>Dec</b>	15	SFCC 15	SFCC 111	SFCC 53
<b>Purpose</b>	Cancels Extended Character Set as selected by SO, SFCC SO, SFCC n, and SFCC 4, and selects the Primary Character Set.			
<b>Discussion</b>	Used in 7-bit systems. If data bit 8 is disabled, this control code selects the range as if data bit 8 is set to 0, and data is printed as characters from hex 20 through 7F.			
<b>Example</b>	Refer to the Extended Character Set example on page 107.			

### Form Feed

<b>ASCII</b>	FF
<b>Hex</b>	0C
<b>Dec</b>	12
<b>Purpose</b>	Prints the data in the buffer, advances the paper position to the next top-of-form and moves the character position to the first character column.
<b>Discussion</b>	The default forms length is determined by the printer configuration. Forms length is set by using the operator panel or forms length control codes. Code FF cancels all single-line only print attributes.  The default form length is 11 inches. The Form Feed command will react differently when the VFU is active. Refer to Chapter 9.

## Forms Length Set (Inches)

**ASCII** SFCC INCHES; *n.f*

**Purpose** Sets the length of forms (paper) in inches.

**where:** *n* = whole numbers from 1 through 24 (hex 01 through hex 18) to specify the number of inches on a page.

*f* = fractional number in .5-inch increments (minimum forms length is .5 inches).

**Discussion** Upon receipt of this code, the current line becomes the first line of the form, and the form length set becomes the current forms length. Vertical tab positions set below the bottom of the form are cleared.

Forms length is defined in inches; therefore, subsequent line spacing changes do not affect the result of this command. Increments of .5-inch can be specified; for example, sending the following command will result in a form length setting of 7-1/2 inches: SFCC INCHES; 7.5

The maximum forms length is 24 inches. All other values are ignored. In INCHES mode, incorrect values will produce an error message.

Forms length can also be set by the operator panel. The control code forms length setting from the host computer will override the operator panel setting. However, if the VFU is enabled and loaded, this command is ignored.

## Forms Length Set (Lines)

**ASCII** SFCC LINES; *n*

**Purpose** Sets the length of a form (paper) in lines.

**where:** *n* = 1 through 192 (hex 01 through hex C0) to specify the number of lines per page at the current line spacing.

**Discussion** The forms length is set to the number of lines defined by the quotient of *n* and the current line spacing so that the units are in inches. In LINES mode, the maximum form length is 24 inches, and *n* values in excess of 24 inches will cause an error message.

If the calculated forms length in lines is not an exact multiple of the target machine dot size, the forms length value will be adjusted down to the next possible multiple.

If the VFU is enabled and loaded, this command is ignored.

## Line Feed

**ASCII** LF

**Hex** 0A

**Dec** 10

**Purpose** Prints the data in the buffer (if any) and advances the vertical character position one line at the current line space setting.

**Discussion** If configured for LF equals new line (LF=CR+LF), the logical print head is positioned at character column 1 of the new line. Otherwise, the logical print head does not move when configured for LF function only (LF=LF ONLY). The LF function cancels all single line print attributes such as double high (elongated) and double wide (expanded) characters.

This code is always configured for LF=CR+LF in the P-Series protocol.

In the P-Series Even Dot Plot mode (high density graphics), the LF code does not cause paper position motion; the data in the buffer is plotted and the logical print head is positioned at character column 1 in anticipation of the Odd Dot Plot control code to complete high density graphic plotting.

In the P-Series Odd Dot Plot mode (normal density graphics), the LF code plots the data in the buffer, advances the paper position a single dot row at the current vertical dot density, and positions the logical print head at character column 1.

## Line Spacing 1/6 Inch (6 lpi)

**ASCII** SFCC LPI;*n* SFCC 2

**Hex** SFCC 32

**Dec** SFCC 50

**Purpose** Sets line spacing to 6 lpi or as set by SFCC A.

**Discussion** For SFCC LPI;*n*, the value of *n* can be 6 or 8 only. If *n* = 6, this command sets line spacing to 1/6 inch. Values of *n* other than 6 or 8 will cause an error message.

SFCC 2 asserts *n*/72-inch line spacing as set by SFCC A (page 112). If no distance has been set by SFCC A, the distance is 1/6 inch.

The control code line spacing selection will override the operator panel line spacing setting.

**Example** The following example illustrates 1/6-inch line spacing and assumes that a distance has not been set by SFCC A.

```
Control code ESC 2 sets
line spacing at
6 lpi for all subsequent lines
until reset or another spacing is selected.
```

## Line Spacing 1/8 Inch (8 lpi)

**ASCII** SFCC 0 SFCC LPI;*n*

**Hex** SFCC 30

**Dec** SFCC 48

**Purpose** Specifies continuous line spacing at 1/8-inch increments (8 lpi).

**Discussion** When the 1/8-inch line spacing control code is received, all lines will be printed at 8 lpi until a new line spacing is selected or the printer is reset. The control code line spacing selection will override the operator panel line spacing setting.

For SFCC LPI;*n*, the value of *n* can be 6 or 8 only. If *n* = 8, this command sets line spacing to 1/8 inch. Values of *n* other than 6 or 8 will cause an error message.

**Example** The following example illustrates 1/8-inch line spacing.

```
Control code ESC 0 sets
line spacing at
1/8 (8 lpi) inch for all subsequent lines
until reset or another spacing is selected.
```

## Line Spacing 8 or 10.3 lpi (1 Line Only)

**ASCII** ACK SFCC f

**Hex** 06 SFCC 66

**Dec** 06 SFCC 102

**Purpose** Selects line spacing of 8 or 10.3 lpi for the current line only.

**Discussion** The default line spacing is reselected automatically after one line. Line spacing may be selected either through the operator panel or by line spacing control codes. The control code setting will override the operator panel line spacing setting.

If the alternate line spacing selected from the operator panel is 8 lpi, the ACK control code will set the line spacing to 8 lpi. If 10.3 lpi was selected from the operator panel, the ACK control code will set the line spacing to 10.3 lpi (7/72 inch).

**Example** The following example illustrates printing a single line of text at 8 lpi.

```
Control code ACK
selects 8 lpi line spacing
for one line only.
The default line spacing is
then reselected automatically.
```

## Line Spacing 7/72 Inch

**ASCII** SFCC 1

**Hex** SFCC 31

**Dec** SFCC 49

**Purpose** Specifies the line spacing at 7/72-inch (10.3 lpi) increments.

**Discussion** When the 7/72-inch line spacing control code is received, all lines will be printed at the 7/72-inch line spacing until a new line spacing is selected or the printer is reset. The control code line spacing selection will override the operator panel line spacing setting, and the message display will reflect the line spacing as lines per inch.

Caution should be used when combining this control code with other print attributes such as Elongated (Double High), Superscript, or Subscript; overlapping lines may occur. Printing at different horizontal and vertical densities will not overlap.

**Example** The following example illustrates 7/72-inch line spacing.

```
Control code ESC 1 sets  
line spacing at  
7/72 inch for all subsequent lines  
until reset or another spacing is selected.
```

## Line Spacing *n*/72 Inch

**ASCII** SFCC A *n*

**Hex** SFCC 41 *n*

**Dec** SFCC 65 *n*

**Purpose** Stores a line spacing of *n*/72-inch increments.

**where:** *n* = 1 through 85 (hex 01 through hex 55) All others are ignored.

**Discussion** When the SFCC A control sequence is received, all line feed commands following an SFCC 2 sequence\* will be at *n*/72-inch line spacing until a new line spacing is selected or the printer is reset. The control code line spacing selection will override the operator panel line spacing setting.

\*The SFCC 2 sequence (page 110) asserts the line spacing which was stored by the preceding SFCC A sequence.

Small values of *n* may result in overlapping lines. Overlapping lines may also occur if print attributes such as Elongated (Double High), Superscript, or Subscript characters are used on the same line. Printing at different horizontal and vertical densities will not overlap.

**Example** The following example illustrates 20/72-inch line spacing.

```
Control code ESC A 20 sets  
line spacing at 20/72 inch  
increments for all subsequent lines  
until reset or another spacing is selected.
```



## Line Spacing $n/216$ Inch

**ASCII** SFCC 3  $n$

**Hex** SFCC 33  $n$

**Dec** SFCC 51  $n$

**Purpose** Specifies the line spacing at  $n/216$ -inch increments.

**where:**  $n = 1$  through 255 (hex 01 through hex FF)

**Discussion** When the  $n/216$ -inch line spacing control code is received, all line feeds following will be at  $n/216$ -inch line spacing until a new line spacing is selected or the printer is reset. The control code line spacing selection will override the operator panel line spacing setting.

The vertical character position moves only in multiples of the current dot row spacing. If the distance to move is other than a multiple of the current dot row spacing, the remainder is added to the next paper motion command.

Caution should be used when combining this control code with other print attributes such as Elongated (Double High), Superscript, or Subscript; overlapping lines may occur. Printing at different horizontal and vertical densities will not overlap.

**Example** The following example illustrates  $n/216$ -inch line spacing.

```
Control code ESC 3 50 sets  
line spacing at 50/216 inch  
increments for all subsequent lines  
until reset or another spacing is selected.
```

## Overscoring

**ASCII** SFCC  $\_n$

**Hex** SFCC 5F  $n$

**Dec** SFCC 95  $n$

**Purpose** Enables or disables automatic overscoring of all characters.

**where:**  $n = 0$  to disable automatic overscoring (hex 00 or hex 30)

$n = 1$  to enable automatic overscoring (hex 01 or hex 31)

**Discussion** When automatic overscore is enabled, all characters, including spaces, will be overscored until disabled.

**Example** The following sample output illustrates automatic overscoring and overscoring reset.

```
Control code ESC  $\_1$   
enables automatic overscoring.  
Control code ESC  $\_0$   
disables automatic overscoring.
```

### Plot, Even Dot (P-Series High Density Graphics)

**ASCII** EOT SFCC d

**Hex** 04 SFCC 64

**Dec** 04 SFCC 100

**Purpose** Prints dots at the even numbered dot columns.

**Discussion** The even dot plot code is used for programming high density graphics and must be used in conjunction with the Odd Dot Plot code (hex 05). Refer to the P-Series Compatible Plot mode section in Chapter 8 for detailed plot mode information.

### Plot, Odd Dot (P-Series Normal Density Graphics)

**ASCII** ENQ SFCC e

**Hex** 05 SFCC 65

**Dec** 05 SFCC 101

**Purpose** Prints dots at the odd numbered dot columns.

**Discussion** This is the P-Series programming normal density graphics control code. The ENQ code should occur before any printable data in the data stream. For high density graphics, the Even Dot Plot code (hex 04) must be used in conjunction with (and precede) the Odd Dot Plot code. Refer to the P-Series Compatible Plot mode section in the Chapter 8 for detailed plot mode information.

### Print Mode/Pitch Selection

**ASCII** SFCC PMODE; *n* SFCC X *mn* SFCC [ *n* *q*

**Hex** SFCC 58 *mn* SFCC 5B *n* 71

**Dec** SFCC 88 *mn* SFCC 91 *n* 113

**Purpose** Selects the print mode and character pitch in characters per inch (cpi).

**where:** In SFCC PMODE; *n*

*n* ranges from 0 through 11 to select the print mode/pitch combinations available from Table 311. All other values will result in an error message.

**where:** In SFCC [ *n* *q*

*n* = Print Mode/Pitch code (values other than those shown in Table 32 are ignored.)

*q* = Command sequence terminator

**where:** In SFCC X *mn*

*m* = Print Mode code *n* = Pitch (cpi)

An asterisk (\*) (hex 2A) may be substituted for *m* or *n*. Whenever the asterisk replaces *m* or *n*, its current value will not change. Values other than those shown in Table 33 and Table 34 are ignored.

**NOTE:** The print mode must be changed before the first printable symbol of a print line or the command sequence is deferred until the next line.

**Discussion** P-Series PMODE switches to the Primary Character Set and selects print mode and pitch.

Print mode and pitch can also be selected from the operator panel. The print mode/pitch select control code from the host computer will override the operator panel print mode setting and the print mode and pitch selection will be reflected on the message display.

A complete set of tables identifying print mode, pitch, and dot densities for all print modes follows.

**Table 31 Print Mode and Pitch – (SFCC PMODE;*n*)**

<i>n</i>	Print Mode and Pitch
0	DP 10 cpi
1	DP 12 cpi
2	DP 15 cpi
3	NLQ 10 cpi
4	Draft 10 cpi
5	OCR-A 10 cpi
6	OCR-B 10 cpi
7	DP 10 cpi upside down
8	DP 12 cpi upside down
9	DP 13 cpi upside down
10	DP 15 cpi upside down
11	DP 17 cpi upside down

**Table 32 Print Mode and Pitch – (SFCC [ *n q* ])**

<i>n</i>	Print Mode and Pitch
1(31)	NLQ 10 cpi
2(32)	DP 12 cpi
3(33)	Draft 12 cpi
4(34)	DP 12 cpi
5(35)	DP 13 cpi

**Table 33 Horizontal and Vertical Dot Density – (SFCC X mn)**

<i>m</i> (Hex)*	Horizontal Density Resolution	Vertical Density	Discussion
0(30)	120 dpi	72 dpi	DP
1(31)	180 dpi	96 dpi	NLQ
2(32)	120 dpi	48 dpi	Draft
3(33)	120 dpi	48 dpi	Draft
4(34)	120 dpi	48 dpi	Draft
5(35)	120 dpi	144 dpi	OCR-A
6(36)	120 dpi	144 dpi	OCR-B
7(37)	120 dpi	72 dpi	DP
8(38)	120 dpi	72 dpi	DP

\* The hex values shown (i.e., 0 and 30) are equal. Either value can be used in you program expression.

**Table 34 Print Mode and Character Pitches (SFCC X mn)**

value of <i>n</i> : Print Mode*	Characters per inch								
	value of <i>m</i> :								
	DP 0(30)	NLQ 1(31)	DRAFT 2(32)	DRAFT 3(33)	DRAFT 4(34)	OCR-A 5(35)	OCR-B 6(36)	DP 7(37)	DP 8(38)
0(30)	10	10	10	10	10	10	10	10	10
1(31)	12	12	12	12	12	-	-	-	-
2(32)	13	13	13	13	13	-	-	-	-
3(33)	15	15	15	15	15	-	-	-	-
4(34)	17	17	17	17	17	-	-	-	-

\* The hex values shown (i.e., 0 and 30) are equal. Either value can be used in your program expression. The value of *m* is represented by the font choice line.

**NOTE:** When using the Multinational character set in OCR-A or OCR-B print mode, a unique character set is used. Refer to the Multinational Character Sets section for more information.

**Example** Any of the BASIC expressions listed below will select the DP print mode at 17 cpi.

**where:** *m* (print mode) = 0 or 30 for DP; and  
*n* (pitch) = 4 or 34 for 17 cpi.  
 CHR\$(1);"X";CHR\$(0);CHR\$(4);  
 CHR\$(1);"X";CHR\$(30);CHR\$(34);  
 CHR\$(1);"X04";

## Reverse

**ASCII Code** SFCC } ; *n*

**Hex Code** SFCC 7D 3B *n*

**Dec Code** SFCC 125 59 *n*

**Purpose** Moves the logical print head up.

**Discussion** If *n* is "L," the print head moves up one line. (Reverse line feed.) If *n* is "P," the print head moves up to the previous top of form. (Reverse form feed.)

## Select Attributes

**ASCII** SFCC [ @ *n1* NUL NUL NUL *n2 n3*

**Hex** 1B 5B 40 *n1* 00 00 00 *n2 n3*

**Dec** 27 91 64 *n1* 0 0 0 *n2 n3*

**Purpose** Selects double high and double wide attributes, and single or double high line spacing.

**Discussion** Parameter *n1* selects the attributes from *n2* and *n3*, as follows:

**Table 35 Select Attributes (*n1*)**

<i>n1</i> Hex Value	Function
03	Set character height and line feed settings according to the value of <i>n2</i> (If <i>n1</i> = 03, there is no <i>n3</i> .)
04	Set character height, line feed, and character settings according to the values of <i>n2</i> and <i>n3</i> .

Parameter *n2* defines the height attributes, as follows:

**Table 36 Select Attributes (*n2*)**

<i>n2</i> Hex Value	Function
00	No change
01	Set single line height characters
02	Set double height characters
10	Set single line spacing
11	Set single height characters and single line spacing
12	Set double height characters and single line spacing
20	Set double line spacing
21	Set single height characters and double line spacing
22	Set double height characters and double line spacing

Parameter *n3* defines the width attributes, as follows:

**Table 37 Select Attributes (*n3*)**

<i>n3</i> Hex	Function
00	No change
01	Set single wide characters
02	Set double wide characters

An SFCC [ @ code can occur at any place in the datastream and is acted upon immediately.

All numerical parameters are in the hex 00 through FF range unless stated otherwise.

### Superscript/Subscript Printing

**ASCII** SFCC S *n*

**Hex** SFCC 53 *n*

**Dec** SFCC 83 *n*

**Purpose** Selects superscript or subscript printing.

**Discussion** An SFCC S code can be set for superscript or subscript printing, as follows:

**where:** *n* = 0 to enable superscript printing (hex 00 or hex 30)

*n* = 1 to enable subscript printing (hex 01 or hex 31)

When this control code is received, all characters will be superscript or subscript until reset by the super/subscript printing reset control code (SFCC T) or printer reset. Use caution when combining this command with other print attributes; arbitrary combinations might yield unexpected results.

**NOTE:** Superscript and subscript characters print at the same size as the current font. They are shifted up or down one half of a line.

**Example** The following sample output illustrates superscript/subscript printing.

```
CONTROL CODE ESC S 0 SELECTSSUPERSCRIPT
A2+B2=C2
CONTROL CODE ESC S 1 SELECTSSUBSCRIPT
31HEX=49DEC
CONTROL CODE ESC T CANCELS
SUPERSCRIPT/SUBSCRIPT PRINTING
```

## Superscript/Subscript Printing Reset

<b>ASCII</b>	SFCC T
<b>Hex</b>	SFCC 54
<b>Dec</b>	SFCC 84
<b>Purpose</b>	Resets superscript and subscript printing.

## Super-Set Commands

<b>ASCII Code</b>	SFCC   };
<b>Hex Code</b>	SFCC 7C 7D 3B
<b>Dec Code</b>	27 124 125 59
<b>Purpose</b>	Control code sequence used to introduce the super-set commands.
<b>Discussion</b>	The “ ” in the command string is the pipe symbol.
<b>Comment</b>	Super-set commands affect the LinePrinter Plus emulation as a whole regardless of the printer protocol currently active. The commands are sent through the host in the input data stream, and enact the following features: <ul style="list-style-type: none"><li>• Select a printer protocol</li><li>• Select a character set</li><li>• Change character spacing</li><li>• Change line spacing</li><li>• Select a barcode</li></ul> Refer to Chapter 7, Super-Set Programming, for further information regarding the Super-Set commands.

## Underline

<b>ASCII</b>	SFCC - <i>n</i>
<b>Hex</b>	SFCC 2D <i>n</i>
<b>Dec</b>	SFCC 45 <i>n</i>
<b>Purpose</b>	Enables or disables automatic underlining of all characters.
<b>where:</b>	<i>n</i> = 0 to disable automatic underlining (hex 00 or hex 30) <i>n</i> = 1 to enable automatic underlining (hex 01 or hex 31)
<b>Discussion</b>	When automatic underline is enabled, all characters, including spaces, will be underlined until disabled.
<b>Example</b>	The following sample output illustrates automatic underlining.

```
Control code ESC -1
enables automatic underlining.
Control code ESC -0
disables automatic underlining.
```

## **VFU Commands (P-Series)**

**ASCII** Refer to the P-Series EVFU section in Chapter 9.

**NOTE:** If the SFCC being used is ESC, the PI line must be set high when using the EVFU.

**Purpose** Load and execute the VFU.

**Discussion** Refer to Chapter 9 for detailed information.

## **Vertical Tab**

**ASCII** VT

**Hex** 0B

**Dec** 11

**Purpose** Prints the data in the buffer and advances the paper to the next vertical tab position.

**Discussion** If a vertical tab format is defined in the EVFU (channel 12) and the VFU is enabled, the paper is moved to the next vertical tab position.

If a vertical tab format is not defined, the paper is advanced to the next line at the current line spacing. More information on Vertical Tabs is provided in the EVFU section of Chapter 9.



# 5 *Serial Matrix Printer Emulation*

## Overview

This chapter describes the Serial Matrix emulation host control codes. “Emulation” refers to the ability of a printer to execute the commands of a particular printer control language. A printer control language is the coding system used to convey, manipulate, and print data. Carriage Return, print quality, character attributes such as bold and underline, margins, and tabs are typical functions selected by printer control language codes. In this manual, the terms emulation, printer protocol, and printer control language are synonymous.

The Serial Matrix emulation is very similar to the code system used by an IBM Graphics Printer, but contains more features. This emulation enables your line matrix printer to print files coded for a serial matrix printer. To select the Serial Matrix emulation mode as the active printer emulation, select LinePrinter+ from the EMULATION menu and Serial Matrix from the Printer Protocol menu, as described in the *Administrator's Manual*.

The Serial Matrix emulation provides many configurable parameters. The default parameter values for this emulation are shown in Table 38. You can modify the emulation parameter values in two ways:

- **The Serial Matrix host control codes.** An extensive set of Serial Matrix control code commands can be sent to the printer from an attached host computer via the host data stream. Most of this chapter is devoted to describing the Serial Matrix control codes.
- **The printer configuration menus.** You can modify a subset of the Serial Matrix emulation parameters using the control panel keys and LCD display, as described in the *Administrator's Manual*.

Control codes sent from a host system generally override previous settings that result from the configuration menus.

Configuration values selected from the menus or via host control codes can be saved to the printer's NVRAM memory so that they will not be lost when you power off the printer or reset it to the factory defaults. The menu selection for saving a configuration to memory is described in the *Administrator's Manual*. Refer to Appendix B, PTX\_SETUP Commands to save the configuration using host control codes.

## Serial Matrix Default Values and States

Your printer memory stores a set of typical operating states and conditions for the P-Series emulation. When you power on the printer and select this emulation, the default settings in Table 38 are automatically invoked.

**Table 38 Serial Matrix Default Settings**

Characteristic	Default Setting
Character Sets	IBM PC
Print Language	
IBM PC	
Select Subset Primary	ASCII (USA)
Select Subset Extended	0437 IBM PC
Multinational	ASCII (USA)
ECMA Latin 1	
Select Subset Primary	ASCII (USA)
Select Subset Extended	Multinational
DEC Multinational	ASCII (USA)
Control Code 06	8.0 LPI
Define CR Code	CR = CR
Auto LF	Enable
Overstrike	Enable
Define LF Code	LF = LF
Printer Select	1
Alternate Set 80-9F	Control Code
Esc d command	Even dot plot

Table 39 lists several additional default settings for parameters that are provided by the Print Format menus (described in the *Administrator's Manual*). Many of the settings shown in Table 39 can be overridden by host control codes for the same parameter.

**Table 39 Print Format Default Settings**

Characteristic	Default Settings
CPI	10.0
LPI	6.0
Forms Width	13.6 inches 345.4 millimeters 136 characters
Forms Length	11.0 inches 279 millimeters 66 lines
Print Quality	DP Quality
Proportional Spacing	Disable
Italic Print	Disable
Slashed Zero	Disable
Left Margin	0 columns
Right Margin	0 columns
Bottom Margin	0 lines
Perforation Skip	Disable

## Configuring the Serial Matrix Emulation with Control Codes

The remainder of this chapter describes the Serial Matrix printer control language codes that may be sent from a host computer attached to the printer, in order to configure and invoke numerous printer functions.

### Format for Control Code Descriptions

The following information is listed for each code function (where applicable and possible).

- Name**            The title or function of the command.
- ASCII**            The standard ASCII name for the control code.
- Hex**                The code's numeric equivalent in hexadecimal.
- Dec**                The code's numeric equivalent in decimal.
- Purpose**            The function(s) of the control code.
- Discussion**      A description of exceptions or limitations to normal use.

**Example** A sample output is provided for some control codes when it is possible to illustrate the effect of a control code, or if a specific syntax is required to complete the program statement (i.e. Horizontal Tab set, Vertical Tab set/clear).

**IMPORTANT** If you specify any parameters for a control code other than those defined in the control code description, unpredictable results may occur.

## Special Function Control Code (SFCC)

When a printer control code consists of more than one character, it is called a command sequence. Every printer protocol uses a Special Function Control Code (SFCC) as the first character of a command sequence. The SFCC alerts the printer that a command sequence—not printable characters— follows.

The ASCII **ESC** character is always the SFCC in this emulation mode.

The general format for a command sequence is:

(ESC)(parameter 1)(parameter 2)...(parameter *n*)

For example, to enable bold print use the ESC character and the bold print control code character G:

**ASCII:** ESC G      **Hex:** 1B 47      **Dec:** 27 71

## Attribute Set and Reset Codes

Certain print attributes are set or reset (turned on or off) by using the appropriate ESC code sequence and the numbers 1 or 0. These may be either the hexadecimal code 01 and 00, or the ASCII code for the printable symbols of decimal 1 and 0 (hexadecimal code 31 and 30, respectively). Expanded Print, Super/Subscript Print, and Underline are attributes which are set/reset in this fashion.

## NUL Code

NUL (Hex 00) is ignored by the printer and can be used as a fill character; however, it can not be used to add blank spaces since it is not a space character. NUL can also be used as a parameter terminator for the Set Horizontal Tabs (page 143) or Set Vertical Tabs multibyte control code (page 154).

**NOTE:** Hex 80 in PC Character Set 1 and Hex 7F in PC Character Set 2 are treated as a NUL; however, these two controls can not be used as parameter terminators.

## Print Modes Supported for Character Sets

Following is a summary of which print modes are supported for the P-Series/ Serial Matrix emulation character sets. Additional information about character set support is provided under the heading “Notes.”

**Table 40 Character Set Print Mode Support**

<b>Character Set</b>	<b>NLQ(Serif)/DP/Draft</b>	<b>Notes</b>
IBM PC, Primary Subset ASCII (USA) French German English (UK) Danish Swedish Italian Spanish Japanese French Canadian Latin American Danish II Spanish II Latin American II	X	The print mode support is the same for all of the IBM PC Primary Subset languages.
IBM PC, Extended Subset 0437 IBM PC 0850 PC Multilingual		The print mode support is the same for both Extended character sets
Multinational ASCII (USA)	X	
Multinational EBCDIC	X	
ECMA Latin I, Primary Subset ASCII (USA) German Swedish Danish Norwegian Finnish English (UK) Dutch French Spanish Italian Turkish Japanese	X	The print mode support is the same for all of the ECMA Latin I Primary Subset languages.
ECMA Latin I, Extended Subset Multinational Barcode 10 CPI Multinational NLQ 10 CPI Greek NLQ 10 CPI Graphic NLQ 10 CPI Scientific NLQ 10 CPI	X	

**Table 40 Character Set Print Mode Support**

Character Set	NLQ(Serif)/DP/Draft	Notes
DEC Multinational ASCII (USA) French German English (UK) Norwegian/Danish Swedish Italian Spanish Japanese French Canadian Dutch Finnish Swiss	X	
ECMA Latin I, Extended Subset Barcode 10 CPI Multinational DP 10 CPI Multinational DP 12 CPI Multinational NLQ 10 CPI Greek DP 10 CPI Greek DP 12 CPI Greek NLQ 10 CPI Graphic DP 10 CPI Graphic NLQ 10 CPI Scientific DP 10 CPI Scientific DP 12 CPI Scientific NLQ 10 CPI	N/A	These character sets are guaranteed readable only in the Print Quality and Print Density specified.
DEC Multinational French German English (UK) Norwegian / Danish Swedish Italian Spanish Japanese French Canadian Dutch Finnish Swiss	X	The print mode support is the same for all of the DEC Multinational languages.
OCR-A / OCR-B	N/A	Only 10 cpi OCR is supported.

## The Control Codes

This index lists each printer command by function, ASCII mnemonic, and the page where the command is explained in detail. "N/A" means not applicable. The rest of this chapter defines the control code functions for Serial Matrix Emulation mode. The commands are listed in alphabetical order.

<b>FUNCTION</b>	<b>ASCII CODE</b>	<b>PAGE</b>
<b>Paper Motion</b>		
Form Feed	FF	141
Line Feed	LF	144
Line Feed <i>n</i> /216 Inch (One line only)	ESC J <i>n</i>	144
Vertical Tab	VT	153
<b>Page Format</b>		
Backspace	BS	129
Cancel	CAN	132
Carriage Return	CR	132
Delete	DEL	137
Forms Length Set (Inches)	ESC C NUL <i>n</i>	142
Forms Length Set (Lines)	ESC C <i>n</i>	142
Horizontal Tab	HT	143
Horizontal Tab Set	ESC D <i>n1</i> ... <i>nk</i> NUL	143
Line Spacing 1/6 Inch (6 lpi)	ESC 2	145
Line Spacing 1/8 Inch (8 lpi)	ESC 0	145
Line Spacing 7/72 Inch	ESC 1	146
Line Spacing <i>n</i> /72 Inch	ESC A <i>n</i>	146
Line Spacing <i>n</i> /216 Inch	ESC 3 <i>n</i>	147
Skip-Over Perforation	ESC N <i>n</i>	151
Skip-Over Perforation Cancel	ESC O	151
Vertical Tab Set/Clear	ESC B <i>n1 n2 n3...nk</i> NUL	154
<b>Print Attributes</b>		
Bold Print	ESC G	131
Bold Print Reset	ESC H	131
Character Pitch 10 cpi	ESC P	133
Character Pitch 12 cpi	ESC M	133
	ESC:	
Condensed Print	SI	137
	ESC SI	
Condensed Print Reset	DC2	137
Elongated (Double High) Print, One line only	ESC h	138
Elongated (Double High) Print, Set/Reset	ESC w <i>n</i>	138
Emphasized Print	ESC E	139
Emphasized Print Reset	ESC F	139
Expanded (Double Wide) Print, Set/Reset	ESC W <i>n</i> DC4	140

<b>FUNCTION</b>	<b>ASCII CODE</b>	<b>PAGE</b>
<b>Print Attributes (continued)</b>		
Expanded (Double Wide) Print, One line only	SO ESC SO	140
Overscoring	ESC _ <i>n</i>	147
Print Mode/Pitch Selection	ESC X <i>mn</i> ESC [ <i>n</i> q	148
Superscript/Subscript Printing	ESC S <i>n</i>	151
Superscript/Subscript Printing Reset	ESC T	152
Underline	ESC – <i>n</i>	153
<b>Graphics</b>		
Bit Image Mode, Single Density	ESC K <i>n1 n2</i>	129
Bit Image Mode, Double Density	ESC L <i>n1 n2</i>	130
Bit Image Mode, Double Density/Speed	ESC Y <i>n1 n2</i>	130
Bit Image Mode, Quadruple Density	ESC Z <i>n1 n2</i>	130
<b>Character Set Control</b>		
Character Set Select	ESC I <i>xyz</i>	133
Characters 80-9F (Control Codes)	ESC 7	135
Characters 80-9F (Printable Symbols)	ESC 6	135
Characters 80-9F (Printable Symbols)	ESC u	135
Character Set Select: International Languages	ESC R <i>n</i>	136
Extended Character Set	ESC 4	141
Extended Character Set Cancel (Primary Character Set Select)	ESC 5	141
<b>Other Functions</b>		
Bell	BEL	129
Emulation Reset	ESC @	139
Printer Select	DC1	150
Printer Deselect	DC3	150
Reverse	ESC } ; <i>n</i>	150
Super-Set Commands	ESC   } ;	152



## Backspace

**ASCII** BS

**Hex** 08

**Dec** 08

**Purpose** Moves the logical print head to the left one character space toward the first character column.

**Discussion** Moves the character position indicator one character space to the left at the current character pitch setting. The code is ignored if the logical print head is positioned at the first character column.

**Example** If you were to print five "T" characters, then two BS commands, then two "=" characters, the output would look like the sample below:

```
TTT##
```

## Bell

**ASCII** BEL

**Hex** 07

**Dec** 07

**Purpose** Sounds the printer buzzer/beeper.

**Discussion** The BEL function will sound the buzzer/beeper for 0.2 seconds upon receipt of this command.

## Bit Image Mode, Single Density

**ASCII** ESC K *n1 n2*

**Hex** 1B 4B *n1 n2*

**Dec** 27 75 *n1 n2*

**Purpose** Selects Single (Normal) Density Bit Image graphics.

**where:** *n1 + 256n2* define the number of data bytes to follow.

DATA = ASCII characters for the dot pattern bytes.

**Discussion** For detailed information, refer to the Bit Image section in Chapter 8.

**Example** The following example produces a pattern of Single Density Bit Image graphics. The 9 data bit pattern is repeated 27 times.

Compare this example to the double density and quadruple density examples.

```
Single Density Bit Image Graphics
NNNNNNNNNNNNNNNNNNNNNNNNNNNNNNNNNN
```



**Discussion** Quadruple Density printing may reduce print speed. For detailed information, refer to the Bit Image section in Chapter 8. The printed density in this mode is 240 dpi horizontal and 72 dpi vertical if selected when the DP (Data Processing) font is active.

**Example** The following example produces quadruple density graphics of the pattern used in the Single Density Bit Image Mode example. Note that the amount of data must be quadrupled for quadruple density (the data is used 108 times rather than 27).

Quad Density Bit Image Graphics



## Bold Print Set

**ASCII** ESC G

**Hex** 1B 47

**Dec** 27 71

**Purpose** Selects bold character printing.

**Discussion** When the bold character printing control code is received, all characters are printed in bold until reset by the bold print reset control code or printer reset. Bold Print is the same as printing double strike.

**Example** The following sample program illustrates bold character printing.

```
Control code ESC G
selects bold character printing,
for example: AaBbCcDdEeFfGgHhIiJjKkLlMmNnOoPp.
Control code ESC H
cancels bold character printing.
```

## Bold Print Reset

**ASCII** ESC H

**Hex** 1B 48

**Dec** 27 72

**Purpose** Resets bold character printing.

**Discussion** The bold print reset control code only resets the bold print character attribute. Other print attributes such as double wide printing are not affected.

**Example** Refer to the Bold Print control code for a sample program of bold character print set and reset.

## Cancel

**ASCII** CAN

**Hex** 18

**Dec** 24

**Purpose** Clears the print buffer of all printable symbols since the last paper motion command was received.

**Discussion** This control code may be used as a delete line function but should be used with extreme care to avoid possible misprinting. This control code will cancel the double wide attribute set by SO if active. No other print attributes are affected.

## Carriage Return

**ASCII** CR

**Hex** 0D

**Dec** 13

**Purpose** Returns the logical print head to the first character column (resets the pointer to the first character position).

**Discussion** The CR code may or may not cause printing or paper motion, depending on the DEFINE CR CODE configuration parameter value. If the DEFINE CR CODE submenu displays the following, the characters following the CR are printed over the previous characters on the line:

```
DEFINE CR CODE
```

```
CR=CR
```

If identical characters are placed in the same position on the line, those characters will be printed in bold (double strike) print when the Overstrike Mode is enabled from the operator panel.

The CR=CR configuration causes subsequent printable data to overprint previous data at half speed if Overstrike is enabled from the operator panel (and prints somewhat faster if Overstrike is disabled), unless an intervening paper motion command is received. If the DEFINE CR CODE submenu displays the following, the control code CR is converted to perform a carriage return and line feed function:

```
DEFINE CR CODE
```

```
CR=CR+LF
```

The CR code in Serial Matrix printer protocol cancels expanded (double wide) print when set by code SO and ESC SO (single line printing attribute).

### Character Pitch 10 CPI

**ASCII** ESC P

**Hex** 1B 50

**Dec** 27 80

**Purpose** Sets character pitch to 10 cpi.

**Discussion** Control Code ESC X can also be used to select a character pitch of 10 cpi. Refer to Print Mode/Pitch Selection on page 148.

### Character Pitch 12 CPI

**ASCII** ESC P ESC :

**Hex** 1B 50 1B 3A

**Dec** 27 80 27 58

**Purpose** Sets character pitch to 12 cpi.

**Discussion** Control Code ESC X can also be used to select a character pitch of 12 cpi. Refer to Print Mode/Pitch Selection on page 148.

### Character Set Select

**ASCII** ESC I xyz (lowercase L)

**Hex** 1B 6C xyz

**Dec** 27 108 xyz

**Purpose** Selects the character set, extended character set, and the international language for a specific character set.

**where:** x is the character set (Table 41);

y is the international language for the selected character set (Table 42);

z is the extended character set for the selected character set (Table 43);

**Table 41 Character Set Select (x)**

<b>x</b>	<b>Character Set</b>
0 (hex 30)	IBM PC
1 (hex 31)	Multinational
2 (hex 32)	ECMA Latin 1
3 (hex 33)	DEC Multinational

**Table 42 International Language Select (y)**

<b>y</b>	<b>x = 0 (hex 30)</b>	<b>x = 1 (hex 31)</b>	<b>x = 2 (hex 32)</b>	<b>x = 3 (hex 33)</b>
	<b>IBM PC</b>	<b>Multinational</b>	<b>ECMA Latin 1</b>	<b>DEC Multinational</b>
0 (hex 30)	ASCII (USA)	ASCII (USA)	ASCII (USA)	ASCII (USA)
1 (hex 31)	French	EBCDIC	German	French
2 (hex 32)	German		Swedish	German
3 (hex 33)	English (UK)		Danish	English (UK)
4 (hex 34)	Danish		Norwegian	Norwegian/Danish
5 (hex 35)	Swedish		Finnish	Swedish
6 (hex 36)	Italian		English (UK)	Italian
7 (hex 37)	Spanish		Dutch	Spanish
8 (hex 38)	Japanese		French	Japanese
9 (hex 39)	French Canadian		Spanish	French Canadian
10 (hex 3A)	Latin American		Italian	Dutch
11 (hex 3B)	Norwegian		Turkish	Finnish
12 (hex 3C)	Danish-II		Japanese	Swiss
13 (hex 3D)	Spanish-II			
14 (hex 3E)	Latin American-II			

**Table 43 International Language Select (z)**

<b>z</b>	<b>x = 0 (hex 30)</b>	<b>x = 1 (hex 31)</b>	<b>x = 2 (hex 32)</b>	<b>x = 3 (hex 33)</b>
	<b>IBM PC</b>	<b>Multinational</b>	<b>ECMA Latin 1</b>	<b>DEC Multinational</b>
0 (hex 30)	IBM PC (0437)	Mult. Extended Set	Barcode 10 cpi	DEC Mult. Ext. Set
1 (hex 31)	IBM PC (0850)		Mult. DP 10 cpi	
2 (hex 32)			Mult. DP 12 cpi	
3 (hex 33)			Mult. NLQ 10 cpi	
4 (hex 34)			Greek DP 10 cpi	
5 (hex 35)			Greek DP 12 cpi	
6 (hex 36)			Greek NLQ 10 cpi	
7 (hex 37)			Graphics DP 10 cpi	
8 (hex 38)			Graphics NLQ 10 cpi	
9 (hex 39)			Scientific DP 10 cpi	
10 (hex 3A)			Scientific DP 12 cpi	
11 (hex 3B)			Scientific NLQ 10 cpi	
12 (hex 3C)			Multinational (at Primary set mode and pitch)	

**Discussion** An asterisk (\*) (hex 2A) may be substituted for x, y, or z. If the asterisk (\*) is the value selected for x, the character set will not change. If \* is the value selected for y or z, the previously selected international language and/or extended character set for the selected character set will be used.

The character set, international language and extended character set can also be selected from the operator panel. The control code setting will override the operator panel selection. Values other than those shown in the tables will result in the control sequence being terminated.

Table 40 provides detailed notes on print mode support for each character set.

### **Characters 80-9F (Control Codes)**

**ASCII** ESC 7

**Hex** 1B 37

**Dec** 27 55

**Purpose** Selects the character set wherein hex codes 80 through 9F are control codes. Also includes hex codes 03 through 06 and 15 in the Serial Matrix printer protocol. Cancels Character Set Select activated by ESC 6 or ESC u.

**Discussion** This feature can also be selected from the operator panel (Alternate Set 80-9F Serial Matrix menu option).

### **Characters 80-9F (Printable Symbols)**

**ASCII** ESC 6

**Hex** 1B 36

**Dec** 27 54

**Purpose** Selects the character set wherein hex codes 80 through 9F are printable symbols. Also includes hex codes 03 through 06 and 15 in the Serial Matrix printer protocol. Cancels Character Set Select activated by ESC 7 or ESC u.

**Discussion** Hex codes 80-9F can also be configured as printable from the operator panel (Alternate Set 80-9F Serial Matrix menu option).

### **Characters 80-9F (Printable Symbols)**

**ASCII** ESC u

**Hex** 1B 75

**Dec** 27 117

**Purpose** Selects the character set wherein hex codes 80 through 9F are printable symbols. Hex codes 03 through 06 and 15 are treated like control codes. Cancels Character Set Select activated by ESC 6 or ESC 7.

**Discussion** Hex codes 80-9F can also be configured as printable from the operator panel (Alternate Set 80-9F Serial Matrix menu option).

## Character Set Select: International Languages

**ASCII** ESC R *n*

**Hex** 1B 52 *n*

**Dec** 27 82 *n*

**Purpose** Specifies the international language set identified by *n* in the basic character set selected from the operator panel (ECMA 94 Latin 1, IBM PC, Multinational, and DEC Multinational).

**where:** *n* corresponds to the language shown in Table 44.

**Table 44 International Character Sets**

<i>n</i>	Character Set Selected			
	ECMA Latin 1	IBM PC (0437 or 0850)	Multinational	DEC Multinational
0 (30)	ASCII (USA)	ASCII (USA)	ASCII (USA)	ASCII (USA)
1 (31)	German	French	EBCDIC	French
2 (32)	Swedish	German		German
3 (33)	Danish	English (UK)		English (UK)
4 (34)	Norwegian	Danish		Norw./Danish
5 (35)	Finnish	Swedish		Swedish
6 (36)	English (UK)	Italian		Italian
7 (37)	Dutch	Spanish		Spanish
8 (38)	French	Japanese		Japanese
9 (39)	Spanish	French Canadian		French Canadian
0A (3A)	Italian	Latin American		Dutch
0B (3B)	Turkish	Norwegian		Finnish
0C (3C)	Japanese	Danish-II		Swiss
0D (3D)		Spanish-II		
0E (3E)		Latin American-II		
0F - 15 (3F - 45)	(currently undefined)			

**Discussion** The international character set can also be selected from the operator panel. The control code setting will override the operator panel character set selection. Values other than those selectable from Table 44 will be ignored.

**Example** The following example illustrates international character selection using the IBM PC character set.

```
Control code ESC R 5 selects
the Swedish character set shown beneath
the USA (ASCII) characters.
```

```
A B C D [ \ ] ^ _ ` { | } ~
A B C D Ä ö Å Ü - é ä ö à ü
```



## Condensed Print

<b>ASCII</b>	SI	ESC SI
<b>Hex</b>	0F	1B 0F
<b>Dec</b>	15	27 15

**Purpose** Selects 17 characters per inch (cpi) condensed print format.

**Discussion** Condensed print can be selected using control code ESC X. Refer to Print Mode/Pitch Selection on page 148.

The Serial Matrix condensed print control code SI affects all subsequent characters. After receiving code SI, all characters will be printed in condensed print until reset by ESC M, ESC P, the condensed print reset control code DC2, printer reset, or a new print mode control code. The Serial Matrix SI code (hex 0F) is equivalent to the ESC SI code. If condensed print is not allowed in the current print mode, the code is ignored.

**Example** The following sample program illustrates condensed character printing and reset.

```
Control code
SI selects
condensed character printing.
Control code DC2
resets condensed character printing.
```

## Condensed Print Reset

<b>ASCII</b>	DC2
<b>Hex</b>	12
<b>Dec</b>	18

**Purpose** Resets condensed character printing to 10 cpi.

**Discussion** The condensed print reset control code selects 10 cpi character pitch. Other print attributes are not affected. Other control code sequences which will cancel condensed print are ESC M, ESC P, ESC @, or a new print mode control code.

**Example** See the Condensed Print control code subsection for an example of Condensed Print Reset.

## Delete

<b>ASCII</b>	DEL
<b>Hex</b>	7F
<b>Dec</b>	127

**Purpose** Deletes the previously received character on a line.

**Discussion** Characters that have been truncated due to line length restrictions are not affected by this code.

## Elongated (Double High) Print (One Line Only)

**ASCII** ESC h

**Hex** 1B 68

**Dec** 27 104

**Purpose** Selects elongated (double high) character printing for one line only. Elongated characters are approximately double height but standard width.

**Discussion** The elongated character control code is a line-by-line print attribute; when the control code is received, all printable characters after the code will be printed double high and then automatically reset. When using this feature with relative line slewing, the paper position will be moved  $n+1$  lines rather than  $n$  lines. Refer to Chapter 9 for more information on relative line slewing. When using small line spacing and the lines overlap, an unexpected print format may result.

**Example** The following sample program illustrates elongated character printing.

```
Control code
ESC h selects
elongated character printing
for one line only.
```

## Elongated (Double High) Print, Set/Reset

**ASCII** ESC w  $n$

**Hex** 1B 77  $n$

**Dec** 27 119  $n$

**Purpose** Turns double-high character printing on and off. Double-high characters are standard width but twice as high.

**where:**  $n = 1$  or 49 (hex 01 or hex 31) turns double high printing on  
 $n = 0$  or 48 (hex 00 or hex 30) turns double high printing off

**Discussion** The OCR A and OCR B fonts cannot be printed in double high.

**NOTE:** It is recommended to use double Line Feeds and Carriage Returns when double-high character printing is on (after an ESC w control code has been sent), or else the printer will overstrike text that has already printed.

If Superscript/Subscript (ESC S) or Condensed Print (SI) is combined with Double High printing, *only* Double High printing will occur.

**Example** The following program illustrates double-high character printing.

```
Control Code ESC w
Selects Double High printing.
Cancels Double High printing.
```

## Emphasized Print

**ASCII** ESC E

**Hex** 1B 45

**Dec** 27 69

**Purpose** Selects emphasized character print format.

**Discussion** When the emphasized print control code is received, all characters will be printed in emphasized print until reset by the emphasized print reset control code or printer reset. The emphasized print attribute is implemented by horizontal shadow printing.

Emphasized print is ignored during superscript or subscript printing, and when 15-20 cpi characters have been selected.

**Example** The following sample program illustrates emphasized character printing.

```
Control code  
ESC E selects  
emphasized character printing.  
Control code ESC F  
cancels emphasized character printing.
```

## Emphasized Print Reset

**ASCII** ESC F

**Hex** 1B 46

**Dec** 27 70

**Purpose** Resets emphasized character printing.

**Discussion** The emphasized print reset control code only resets the emphasized print character attribute.

**Example** See the Emphasized Print control code subsection for an example of Emphasized Print Reset.

## Emulation Reset

**ASCII** ESC @

**Hex** 1B 40

**Dec** 27 64

**Purpose** Initializes all print mode related parameters to the power-up configuration value.

**Discussion** Print mode, line spacing, international language selection, margins, form length, skip-over perforation, and character pitch are reset to the power-up configuration value. Character-by-character and line-by-line attributes are canceled. The vertical format unit is cleared. The current line is set to the top-of-form position. Interface parameters and printer protocol selection are not affected.

This command will reset the horizontal tabs to every eighth character column.

## Expanded (Double Wide) Print

**ASCII**        ESC W *n*    DC4

**Hex**         1B 57 *n*    14

**Dec**         27 87 *n*    20

**Purpose**       Selects or resets expanded (double wide) print.

**where:**       *n* = 1 selects expanded print (hex 01 or hex 31)

*n* = 0 resets expanded print (hex 00 or hex 30)

**Discussion**    When expanded print using ESC W is received, all characters will be printed double wide until reset by the Expanded Print Reset control code, Emulation Reset, or DC4.

Also refer to control code SO and ESC SO, Expanded (Double Wide) Print for one line only.

**Example**       The following sample program illustrates expanded character printing and expanded character printing reset.

```
Control code
ESC W 1 selects
expanded character printing.
Control code
ESC W 0 resets
expanded character printing.
```

## Expanded (Double Wide) Print (One Line Only)

**ASCII**        SO        ESC SO

**Hex**         0E        1B 0E

**Dec**         14        27 14

**Purpose**       Selects expanded (double wide) print for one line only.

**Discussion**    This expanded print control code is a line-by-line print attribute; when the SO or ESC SO control code is received, all printable characters after the will be printed double wide and then automatically reset.

This control code can be reset by a paper motion control code (LF, VT, CR, etc.), by the DC4 (double wide cancel) code, ESC @ (Emulation Reset), CAN or ESC W (double wide print). When set by SO, double wide print is not cancelled by the Autowrap feature.

**Example**       The following sample program illustrates Expanded Print for one line only. Another example of expanded printing is shown for Expanded (Double Wide) Print, ESC W on page 140.

```
Control code
SO selects
expanded character printing
for one line only.
```

## Extended Character Set

<b>ASCII</b>	ESC 4
<b>Hex</b>	1B 34
<b>Dec</b>	27 52
<b>Purpose</b>	Accesses the extended character set in the range hex A0 through FF using codes hex 20 through 7F.
<b>Discussion</b>	This code is used in 7-bit systems as if data bit 8 was set to 1. For example, sending code hex 20 accesses the symbol at code point hex A0. If a printable symbol is not available at the code point, a space is printed.  ESC 4 is not cancelled by the next paper motion command.
<b>Example</b>	The following sample program illustrates Extended Character Set.

```
Control code
ESC 4 selects the extended character set
and ESC 5 selects the primary character set
which is displayed beneath the extended character set.

T T T T T T T T
ABCDEF GH
```

## Extended Character Set Cancel (Primary Character Set Select)

<b>ASCII</b>	ESC 5
<b>Hex</b>	1B 35
<b>Dec</b>	27 53
<b>Purpose</b>	Cancels Extended Character Set as selected by ESC 4, and selects the Primary Character Set.
<b>Discussion</b>	This code is used in 7-bit systems as if data bit 8 was set to 0, and data is printed as characters from hex 20 through hex 7F.
<b>Example</b>	Refer to the Extended Character Set example above.

## Form Feed

<b>ASCII</b>	FF
<b>Hex</b>	0C
<b>Dec</b>	12
<b>Purpose</b>	Prints the data in the buffer, advances the paper position to the next top-of-form, and moves the character position to the first character column.
<b>Discussion</b>	The default forms length is determined by the configuration in nonvolatile memory. Forms length is set by using the operator panel or forms length control codes. Code FF cancels all single-line only print attributes.  The Form Feed command will react differently when the VFU is active (refer to Chapter 9).

## Forms Length Set (Inches)

**ASCII** ESC C NUL *n*

**Hex** 1B 43 00 *n*

**Dec** 27 67 0 *n*

**Purpose** Sets the length of forms (paper) in inches.

**where:** *n* = whole numbers from 1 through 24 (hex 01 through hex 18) to specify the number of inches on a page.

**Discussion** Upon receipt of this code, the current line becomes the first line of the form, and the form length set becomes the current forms length. Vertical tab positions set below the bottom of the form are ignored. Forms length is defined in inches; therefore, subsequent line spacing changes do not affect the result of this command.

The maximum forms length is 24 inches. All other values are ignored.

When forms length is set by the ESC C sequence, the skip-over perforation is set to zero.

Forms length can also be set through the operator panel. The control code forms length setting from the host computer will override the operator panel setting.

## Forms Length Set (Lines)

**ASCII** ESC C *n*

**Hex** 1B 43 *n*

**Dec** 27 67 *n*

**Purpose** Sets the length of a form (paper) in lines.

**where:** *n* = 1 through 192 (hex 01 through hex C0) to specify the number of lines per page at the current line spacing.

**Discussion** The forms length set becomes the current forms length. The forms length units are always defined in inches; therefore, subsequent line spacing changes do not affect the result of this command. Changing lpi does not change the forms length.

The forms length is set to the number of lines defined by the quotient of *n* and the current line spacing so that the units are in inches.

If the calculated forms length in lines is not an exact multiple of the target machine dot size, the forms length value will be adjusted down to the next possible multiple.

When forms length is set by the ESC C sequence, the skip-over perforation is set to zero.

Forms length can also be set through the operator panel. The control code forms length setting from the host computer will override the operator panel setting.

## Horizontal Tab

**ASCII** HT

**Hex** 09

**Dec** 09

**Purpose** Moves the logical printhead right to the next horizontal tab stop.

**Discussion** Power-on default horizontal tabs are set at every eighth character in the Serial Matrix printer protocol. If there are no horizontal tabs set or the logical printhead is located at the last character column, the code is ignored and no movement occurs.

Horizontal tabs are stored as a relative position; therefore, character pitch changes will change horizontal tab positions. See Horizontal Tab Set on page 143, to set new tab positions.

## Horizontal Tab Set

**ASCII** ESC D *n1* ... *nk* NUL

**Hex** 1B 44 *n1* ... *nk* 00

**Dec** 27 68 *n1* ... *nk* 0

**Purpose** Sets up to 32 horizontal tab positions.

**where:** *n1* through *n32* specify the character column of the tab positions. NUL is the sequence terminator. ESC D NUL clears all tabs.

**Discussion** Up to 32 different tab positions may be set. The values must be listed in ascending order or they are ignored. The physical tab position is the product of *n* and the current cell width (1/pitch), excluding double wide. Tabs in excess of 32 or those positioned beyond the paper's right margin are also ignored.

Tab positions may be cleared by sending the ESC D NUL sequence. Powering the printer on/off will initialize the tabs to every eighth character column. Horizontal tabs are accessed by control code HT.

**Example** The following example illustrates horizontal tab setting and accessing.

```
Control code
ESC D CHR$(4);CHR$(10);CHR$(0)
sets tab stops at columns 4 and 10.
Control code HT
accesses the tab stops as follows:
    column 4
        column 10
```

## Line Feed

**ASCII** LF

**Hex** 0A

**Dec** 10

**Purpose** Prints the data in the buffer (if any) and advances the vertical character position one line at the current line space setting.

**Discussion** If configured for LF equals newline (LF=CR+LF), the logical print head is positioned at character column 1 of the new line.

Otherwise, the logical print head does not move when configured for LF function only (LF=LF ONLY). The LF function cancels all single line print attributes such as double high (elongated) and double wide (expanded) characters.

## Line Feed *n*/216 Inch (One Line Only)

**ASCII** ESC J *n*

**Hex** 1B 4A *n*

**Dec** 27 74 *n*

**Purpose** Advances the vertical character position *n*/216 inch for one line only.

**where:** *n* = 1 through 255 (hex 01 through hex FF)

**Discussion** The *n*/216-inch line feed control code is effective for one line only. All single-line-only print attributes are canceled.

If the protocol is configured for LF equals newline (LF=CR+LF), the paper advances one line at the current line space setting and the logical print head is positioned at character column 1.

The paper position moves only in multiples of the current dot row spacing. If the distance to move is other than a multiple of the current dot row spacing, the remainder is added to the next paper motion command.

Small values of *n* may result in overlapping lines. Overlapping lines may also occur if print attributes such as Elongated (Double High), Superscript, or Subscript characters are used on the same line. Printing at different horizontal and vertical densities will not overlap.

**Example** The following example illustrates *n*/216-inch line spacing.

```
Control code ESC J 200
```

```
performs a 200/216 inch  
line feed function for one line only.
```



## Line Spacing 1/6 Inch (6 lpi)

**ASCII** ESC 2 ESC A *n*

**Hex** 1B 32 1B 41

**Hex** 27 50 27 65

**Purpose** ESC 2 sets line spacing to 6 lpi, or as set by ESC A.

**Discussion** The value of *n* should be 12 if using ESC A *n*.

ESC 2 asserts *n*/72-inch line spacing as set by ESC A (page 146). If no distance has been set by ESC A, the distance is 1/6 inch.

The control code line spacing selection will override the operator panel line spacing setting.

**Example** The following example illustrates 1/6-inch line spacing and assumes that a distance has not been set by ESC A.

```
Control code ESC 2 sets  
line spacing at  
6 lpi for all subsequent lines  
until reset or another spacing is selected.
```

## Line Spacing 1/8 Inch (8 lpi)

**ASCII** ESC 0 ESC A *n*

**Hex** 1B 30 1B 41

**Dec** 27 48 27 65

**Purpose** Specifies continuous line spacing at 1/8-inch increments (8 lpi).

**Discussion** When the 1/8-inch line spacing control code, ESC 0, is received, all lines will be printed at 8 lpi until a new line spacing is selected or the printer is reset. The control code line spacing selection will override the operator panel line spacing setting.

The value of *n* should be 9 if using ESC A *n*.

**Example** The following example illustrates 1/8-inch line spacing.

```
Control code ESC 0 sets  
line spacing at  
1/8 (8 lpi) inch for all subsequent lines  
until reset or another spacing is selected.
```

## Line Spacing 7/72 Inch

**ASCII** ESC 1

**Hex** 1B 31

**Dec** 27 49

**Purpose** Specifies the line spacing at 7/72-inch (10.3 lpi) increments.

**Discussion** When the 7/72-inch line spacing control code is received, all lines will be printed at the 7/72-inch line spacing until a new line spacing is selected or the printer is reset. The control code line spacing selection will override the operator panel line spacing setting, and the message display will reflect the line spacing as lines per inch.

**NOTE:** Caution should be used when combining this control code with other print attributes such as Elongated (Double High), Superscript, or Subscript; overlapping lines may occur. Printing at different horizontal and vertical densities will not overlap.

**Example** The following example illustrates 7/72-inch line spacing.

```
Control code ESC 1 sets  
line spacing at  
7/72 inch for all subsequent lines  
until reset or another spacing is selected.
```

## Line Spacing $n/72$ Inch

**ASCII** ESC A  $n$

**Hex** 1B 41  $n$

**Dec** 27 65  $n$

**Purpose** Stores a line spacing of  $n/72$ -inch increments.

**where:**  $n = 1$  through 85 (hex 01 through hex 55). All others are ignored.

**Discussion** When the ESC A control sequence is received, all line feed commands following an ESC 2 sequence\* will be at  $n/72$ -inch line spacing until a new line spacing is selected or the printer is reset. The control code line spacing selection will override the operator panel line spacing setting.

\*The ESC 2 sequence (page 145) asserts the line spacing which was stored by the preceding ESC A sequence.

Small values of  $n$  may result in overlapping lines. Overlapping lines may also occur if print attributes such as Elongated (Double High), Superscript, or Subscript characters are used on the same line. Printing at different horizontal and vertical densities will not overlap.

**Example** The following example illustrates 20/72-inch line spacing.

```
Control code ESC A 20 sets  
line spacing at 20/72 inch  
increments for all subsequent lines  
until reset or another spacing is selected.
```

## Line Spacing $n/216$ Inch

**ASCII** ESC 3  $n$

**Hex** 1B 33  $n$

**Dec** 27 51  $n$

**Purpose** Specifies the line spacing at  $n/216$ -inch increments.

**where:**  $n = 1$  through 255 (hex 01 through FF)

**Discussion** When the  $n/216$ -inch line spacing control code is received, all line feeds following will be at  $n/216$ -inch line spacing until a new line spacing is selected or the printer is reset. The control code line spacing selection will override the operator panel line spacing setting.

The vertical character position moves only in multiples of the current dot row spacing. If the distance to move is other than a multiple of the current dot row spacing, the remainder is added to the next paper motion command.

**NOTE:** Caution should be used when combining this control code with other print attributes such as Elongated (Double High), Superscript, or Subscript; overlapping lines may occur. Printing at different horizontal and vertical densities will not overlap.

**Example** The following example illustrates  $n/216$ -inch line spacing.

```
Control code ESC 3 50 sets  
line spacing at 50/216 inch  
increments for all subsequent lines  
until reset or another spacing is selected.
```

## Overscoring

**ASCII** ESC \_  $n$

**Hex** 1B 5F  $n$

**Dec** 27 95  $n$

**Purpose** Enables or disables automatic overscoring of all characters.

**where:**  $n = 0$  to disable automatic overscoring (hex 00 or hex 30)

$n = 1$  to enable automatic overscoring (hex 01 or hex 31)

**Discussion** When automatic overscore is enabled, all characters, including spaces, will be overscored until disabled.

**Example** The following sample program illustrates automatic overscoring and overscoring reset.

```
Control code ESC _ 1  
enables automatic overscoring.  
Control code ESC _ 0  
disables automatic overscoring.
```

## Print Mode/Pitch Selection

**ASCII** ESC X *mn* ESC [ *nq*

**Hex** 1B 58 *mn* 1B 5B *n71*

**Dec** 27 88 *mn* 27 91 *n113*

**Purpose** Selects the print mode (DP, NLQ, DRAFT, or OCR) and character pitch in characters per inch (cpi).

**where:** For ESC[ *nq*:

*n* = Print Mode/Pitch code (values other than those shown in Table 45 are ignored); *q* = Command sequence terminator.

**where:** For ESC X *mn*:

*m* = Print Mode code; *n* = Pitch (cpi).

An asterisk (\*) (hex 2A) may be substituted for *m* or *n*. Whenever the asterisk replaces *m* or *n*, then its current value will not change. Values other than those shown in Table 46 and Table 47 are ignored.

**NOTE:** The print mode must be changed before the first printable symbol of a print line or the command sequence is deferred until the next line.

**Discussion** Print mode and pitch can also be selected from the operator panel. The print mode/pitch select control code from the host computer will override the operator panel print mode setting and the print mode and pitch selection will be reflected on the message display.

A complete set of tables identifying print modes, pitch, and dot densities for all print modes follows.

**Table 45 Print Mode and Pitch (ESC[*nq*)**

<i>n</i>	Print Mode and Pitch
1 (31)	NLQ 10 cpi
2 (32)	DP 10 cpi
3 (33)	HS 12 cpi
4 (34)	DP 12 cpi
5 (35)	DP 13 cpi

**Table 46 Horizontal and Vertical Dot Density (ESC X)**

<i>m</i> (Hex*)	Horiz. Density Resolution	Vertical Density	Print Mode
0 (30)	120 dpi	72 dpi	DP
1 (31)	180 dpi	96 dpi	NLQ
2 (32)	120 dpi	48 dpi	HS
3 (33)	120 dpi	48 dpi	HS
4 (34)	120 dpi	48 dpi	HS
5 (35)	120 dpi	144 dpi	OCR-A
6 (36)	120 dpi	144 dpi	OCR-B
7 (37)	120 dpi	72 dpi	DP
8 (38)	120 dpi	72 dpi	DP

\*The hex values shown (i.e., 0 and 30) are equal. Either value can be used in your program expression.

**Table 47 Print Mode and Character Pitches (ESC Xmn)**

Characters Per Inch									
value of <i>n</i> : Print Mode*	value of <i>m</i> :								
	DP 0 (30)	NLQ 1 (31)	HS 2 (32)	HS 3 (33)	HS 4 (34)	OCR-A 5 (35)	OCR-B 6 (36)	NLQ2 7 (37)	NLQ2 8 (38)
0 (30)	10	10	10	10	10	10	10	10	10
1 (31)	12	12	12	12	12	–	–	12	12
2 (32)	13	13	13	13	13	–	–	13	13
3 (33)	15	15	15	15	15	–	–	15	15
4 (34)	17	17	17	17	17	–	–	17	17
5 (35)	20	20	20	20	20	–	–	20	20

\*The hex values shown (i.e., 0 and 30) are equal. Either value can be used in your program expression. The value of *m* is represented by the font choice line.

**NOTE:** When using the Multinational character set in OCR-A or OCR-B print mode, a unique character set is used.

**Example** Any of the BASIC expressions listed below will select the Data Processing print mode at 17.1 cpi.

**where:**  $m$  (print mode) = 0 or 30 for Data Processing; and

$n$  (pitch) = 4 or 34 for 17.1 cpi.

CHR\$(27);"X";CHR\$(0);CHR\$(4);

CHR\$(27);"X";CHR\$(30);CHR\$(34);

CHR\$(27);"X04";

### Printer Select

**ASCII** DC1

**Hex** 11

**Dec** 17

**Purpose** Places printer in the selected state.

**Discussion** When the configuration parameter PRINTER SELECT is enabled, this control code will allow the printer to receive and print data from the host.

Printer Deselect (code DC3) disables the printer from receiving data.

### Printer Deselect

**ASCII** DC3

**Hex** 13

**Dec** 19

**Purpose** Places printer in the deselected state.

**Discussion** When the configuration parameter PRINTER SELECT is enabled, this control code will disable the printer from receiving and printing data from the host. Until a DC1 (Printer Select) command is received, all subsequent data to the printer is ignored.

**NOTE:** When the configuration parameter PRINTER SELECT is enabled and saved in the configuration, the printer will power up in the deselected state.

### Reverse

**ASCII** ESC } ;  $n$

**Hex** ESC 7D 3B  $n$

**Dec** ESC 125 59  $n$

**Purpose** Moves the logical print head up.

**Discussion** If  $n$  is "L", the print head moves up one line. (Reverse line feed.) If  $n$  is "P", the print head moves up to the previous top of form. (Reverse form feed.)

## Skip-Over Perforation

**ASCII** ESC N *n*

**Hex** 1B 4E *n*

**Dec** 27 78 *n*

**Purpose** Selects the number of lines (at the current line spacing) for the paper to skip at the bottom of the perforated page.

**where:** *n* = 1 through 127 (hex 01 through hex 7F) to select the number of lines to skip. If the value of *n* exceeds the current form's length, it is ignored.

**Discussion** The actual distance set is the product of *n* and the current line spacing. Factory default value disables bottom margin. The current default value may be set by the operator. Setting a new forms length (ESC C) resets bottom margin to zero.

This feature is disabled whenever vertical tabs are set.

The bottom margin can also be selected from the operator panel; however, vertical tabs within the bottom margin zone, as set by the operator panel, are ignored. The control code bottom margin setting from the host computer will override the operator panel setting.

## Skip-Over Perforation Cancel

**ASCII** ESC O (alpha O)

**Hex** 1B 4F

**Dec** 27 79

**Purpose** Resets bottom margin to zero.

## Superscript/Subscript Printing

**ASCII** ESC S *n*

**Hex** 1B 53 *n*

**Dec** 27 83 *n*

**Purpose** Selects superscript or subscript printing.

**where:** *n* = 0 to enable superscript printing (hex 00 or hex 30)

*n* = 1 to enable subscript printing (hex 01 or hex 31)

**Discussion** Superscript and subscript characters print at the same size as the current font. They are shifted up or down one half of a line. When the super/subscript control code is received, all characters will be superscript or subscript until reset by the super/subscript reset control code or printer reset. Emphasized print is ignored in the super/subscript print mode.

Both superscript and subscript characters can be printed in the same character column using the Backspace (BS) control code (page 129).

**NOTE:** Caution should be used when combining Superscript or Subscript printing with other print attributes such as Elongated (Double High), or small line spacing; overlapping lines may occur. Characters with different horizontal or vertical dot densities will not overlap.

**Example** The following sample program illustrates superscript/subscript printing.

```
CONTROL CODE ESC S 0 SELECTSSUPERSCRIPT  
A2+B2=C2  
CONTROL CODE ESC S 1 SELECTSSUBSCRIPT  
31HEX=49DEC  
CONTROL CODE ESC T CANCELS  
SUPERSCRIPT/SUBSCRIPT PRINTING
```

### Superscript/Subscript Printing Reset

<b>ASCII</b>	ESC T
<b>Hex</b>	1B 54
<b>Dec</b>	27 84
<b>Purpose</b>	Resets superscript and subscript printing as set by ESC S.

### Super-Set Commands

<b>ASCII</b>	ESC  } ;
<b>Hex</b>	1B 7C 7D 3B
<b>Dec</b>	27 124 125 59
<b>Purpose</b>	Control code sequence used to introduce the super-set commands.
<b>Discussion</b>	The “ ” in the command string is the pipe symbol.
<b>Comment</b>	Super-set commands affect the LinePrinter Plus emulation as a whole regardless of the printer protocol currently active. The commands are sent through the host in the input data stream, and enact the following features: <ul style="list-style-type: none"><li>• Select a printer protocol</li><li>• Choose character sets</li><li>• Specify character spacing</li><li>• Specify line spacing</li><li>• Choose barcode formats</li><li>• Refer to Chapter 7 for further information.</li></ul>



## Underline

**ASCII** ESC – *n*

**Hex** 1B 2D *n*

**Dec** 27 45 *n*

**Purpose** Enables or disables automatic underlining of all characters.

**where:** *n* = 0 to disable automatic underlining (hex 00 or hex 30)

*n* = 1 to enable automatic underlining (hex 01 or hex 31)

**Discussion** When automatic underline is enabled, all characters, including spaces, will be underlined until disabled.

**Example** The following sample program illustrates automatic underlining and underlining reset.

```
Control code ESC -1
enables automatic underlining.
Control code ESC -0
disables automatic underlining.
```

## Vertical Tab

**ASCII** VT

**Hex** 0B

**Dec** 11

**Purpose** Prints the data in the buffer and advances the paper to the next vertical tab position.

**Discussion** Vertical tab positions are set by control code ESC B and executed by control code VT. In this mode, if vertical tabs are loaded, the paper position moves to the next vertical tab position.

If a vertical tab format is not defined, the paper position is advanced to the next line at the current line spacing. If a vertical tab format is defined but no vertical tab positions are set between the current print position and the end of the form, the paper position is advanced to the top of the next form. The VT code resets all single line print attributes. More information on vertical tabs is provided in Chapter 9.

## Vertical Tab, Set/Clear

**ASCII** ESC B *n1 n2 n3...nk* NUL

**Hex** 1B 42 *n1 n2 n3...nk* 00

**Dec** 27 66 *n1 n2 n3...nk* 0

**Purpose** Sets vertical tab positions.

**where:** *n1* through *nk* specify the line number for the vertical tab(s), for a maximum of 16 tab positions. NUL must be used as the sequence terminator.

**Discussion** The physical position on the paper is the product of *n* and the current line spacing. Subsequent line spacing changes do not change the tab position. If the value of *n* defines a tab stop that exceeds the forms length, that tab position is ignored.

In the Serial Matrix printer protocol, vertical tab positions are set by control code ESC B and executed by control code VT. The tab positions must be in ascending order or the sequence will terminate. More information regarding Serial Matrix vertical tab setting is provided in Chapter 9. If the ESC B command is followed immediately by NUL, the vertical tab positions are cleared.

**Example** The following sample program illustrates Vertical Tab Setting.

```
Control code
ESC B 15 20 0 sets a vertical tab at line 15 and at line 20.
Control code VT moves paper to the next vertical tab.

Control code VT moves paper to the next vertical tab.
```

```
This is line twenty.
```

# 6 *P-Series XQ Variant Printer Emulation*

## Overview

This chapter describes the P-Series XQ emulation host control codes. “Emulation” refers to the ability of a printer to execute the commands of a particular printer control language. A printer control language is the coding system used to convey, manipulate, and print data. Carriage Return, print quality, character attributes such as bold and underline, margins, and tabs are typical functions selected by printer control language codes. In this manual, the terms emulation, printer protocol, and printer control language are synonymous.

The P-Series XQ emulation was devised for a series of Printronix printers manufactured between 1974 and 1991, but no longer available. This emulation enables your printer to emulate Printronix P300 and P600 printers with A7/B10 boards. To select the P-Series XQ emulation mode as the active printer emulation, select LinePrinter+ from the EMULATION menu and P-Series XQ from the Printer Protocol menu, as described in the *Administrator’s Manual*.

The P-Series XQ emulation provides many configurable parameters. The default parameter values for this emulation are shown in Table 48. You can modify the emulation parameter values in two ways:

- **The P-Series XQ host control codes.** An extensive set of P-Series XQ control code commands can be sent to the printer from an attached host computer via the host data stream. Most of this chapter is devoted to describing the P-Series XQ control codes.
- **The printer configuration menus.** You can modify a subset of the P-Series XQ emulation parameters using the control panel keys and LCD, as described in the *Administrator’s Manual*.

Control codes sent from a host system generally override previous settings that result from the configuration menus.

Configuration values selected from the menus or via host control codes can be saved to the printer's NVRAM memory so that they will not be lost when you power off the printer. The menu selection for saving a configuration to memory is described in the *Administrator’s Manual*. Refer to Appendix B, PTX\_SETUP Commands to save the configuration using host control codes.

## **P-SSeries XQ Variant Default Values and States**

Your printer memory stores a set of typical operating states and conditions for the P-Series XQ Variant emulation. When you power on the printer and select this emulation, the default settings in Table 48 are automatically invoked.

**Table 48 P-Series XQ Default Settings**

Characteristic	Default Setting
Control Code 06	8.0 LPI
Define CR Code	CR = CR
Auto LF	Disable
Define LF Code	LF = CR + LF
Compressed Print	Char 01 SOH
Elong./Alt Font	ELNG=BS FONT=SO
High Speed (Draft) Print Mode	Char 02 STX
EVFU Selected	Enable
Uppercase Select	Disable
Slew Relative	1-16 Lines

Table 49 lists several additional default settings for parameters that are provided by the Print Format menus (described in the *Administrator's Manual*). Many of the settings shown in Table 49 can be overridden by host control codes for the same parameter.

**Table 49 Print Format Default Settings**

Characteristic	Default Settings
CPI	10.0
LPI	6.0
Forms Width	13.6 inches 345.4 millimeters 136 characters
Forms Length	11.0 inches 279 millimeters 66 lines
Print Quality	DP Quality
Proportional Spacing	Disable
Italic Print	Disable
Slashed Zero	Disable
Left Margin	0 columns
Right Margin	0 columns
Bottom Margin	0 lines
Perforation Skip	Disable

# Configuring the XQ Variant Emulation with Control Codes

The remainder of this chapter describes the P-Series XQ Variant printer control language codes that may be sent from a host computer attached to the printer, in order to configure and invoke numerous printer functions.

## Format for Control Code Descriptions

The following information is listed for each code function (where applicable and possible).

- Name**            The title or function of the command.
- ASCII**            The standard ASCII name for the control code. **Hex**        The code's numeric equivalent in hexadecimal. **Dec**        The code's numeric equivalent in decimal.
- Purpose**            The function(s) of the control code.
- Discussion**        A description of exceptions or limitations to normal use.
- Example**            A sample output is provided for some control codes when it is possible to illustrate the effect of a control code, or if a specific syntax is required to complete the program statement (i.e. Horizontal Tab set, Vertical Tab set/clear).
- IMPORTANT**        **If you specify any parameters for a control code other than those defined in the control code description, unpredictable results may occur.**

## Edit Mode

**NOTE:** To use Edit mode in the XQ emulation, you must configure the printer for a carriage return only (CR = CR). If the printer is configured for a carriage return with a line feed (CR = CR + LF), the contents of the buffer print immediately after execution of the CR code, disabling the CR editing function.

Any printable character in the data stream can replace printable characters or spaces already loaded in the print buffer. The space character (hex 20) is used to skip characters in the print buffer that are not to be replaced and, similar to underlining or deleting, the new characters are inserted in the appropriate positions.

Table 50 illustrates the edit mode. Note that the editing function replaces characters; it cannot be used to print the same character twice (double strike) in the same location. Use the DEL code (hex 7F) to make a character blank.

**Table 50 CR Edit Mode Example**

	Enter in Print Buffer	Printed Result
<b>Example 1</b>	AAABBBCCC(CR) SSSDSSSB(LF)	AAABDBCCB
<b>Example 2</b>	ABCDEF(CR) _(CR)	<u>ABCDEF</u>
<b>Key:</b>	S = Space (hex 20); LF = Line Feed (hex 0A); CR = Carriage Return (hex 0D)	

## NUL Code

NUL (hex 00) is ignored by the printer and can be used as a fill character; however, it can not be used to add blank spaces since it is not a space character.

## The Control Codes

This index lists each printer command by function, ASCII mnemonic, and the page where the command is explained in detail. "N/A" means not applicable. The rest of this chapter defines the control code functions for P-Series XQ Emulation mode. The commands are listed in alphabetical order.

<b>FUNCTION</b>	<b>ASCII CODE</b>	<b>PAGE</b>
<b>Vertical Motion</b>		
Electronic Vertical Format Unit (EVFU) DLE - US		161
<b>NOTE:</b> Channel codes 10 through 1F hex are used when the PI line is disabled. See Chapter 9 for applicable PI enable channel codes.		
Form Feed	FF	162
Line Feed	LF	163
Line Spacing (8 or 10.3 LPI)	ACK	163
Vertical Tab	VT	166
<b>Horizontal Motion</b>		
Carriage Return	CR	160
Space	SP	165
<b>Emphasis</b>		
Underline	–	165
Space	SP	165
<b>Font Control</b>		
Compressed Print	SOH, ETX, HT	160
Elongated Characters (Double High)	BS, SO	162
Select Draft Print	STX, ETX, HT	165
<b>NOTE:</b> The Compressed Print, Elongated Characters, and Shift Out parameters can be configured at the operator panel (see <i>Administrator's Manual</i> ).		
<b>Character Set Control</b>		
Alternate Character Set Deselect (Shift In)	SI	159
Alternate Character Set Select (Shift Out)	SO BS	159
<b>Data Manipulation</b>		
Delete	DEL	161
Space	SP	165
<b>Graphics</b>		
Plot, Even Dot	EOT	164
Plot, Odd Dot	ENQ	164

## Alternate Character Set Deselect (Shift In)

ASCII SI

Hex 0F

Dec 15

**Purpose** This code selects the primary character set.

**Discussion** The alternate character set select and deselect codes can be used to mix primary and alternate characters on a single line. The main character set is also automatically selected when a line terminator code is received.

### Example

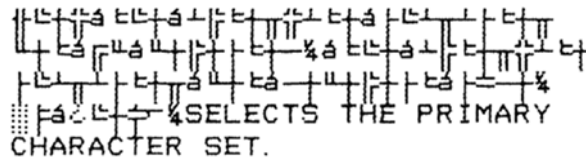

SELECTS THE PRIMARY  
CHARACTER SET.

## Alternate Character Set Select (Shift Out)

ASCII SO BS

Hex 0E 08

Dec 14 08

**Purpose** Accesses the extended character set in the range of hex A0 through FF using codes hex 20 through 7F.

**NOTE:** An alternate hex code of 08 (ASCII code BS) can be assigned as the Alternate Character Set Select control code through printer configuration.

**Discussion** These codes are used in 7-bit systems as if data bit 8 were set to 1. For example, sending code hex 20 accesses the symbol at code point hex A0. If a printable symbol is not available at the code point, a space is printed. Both commands are cancelled by a paper motion command.

### Example

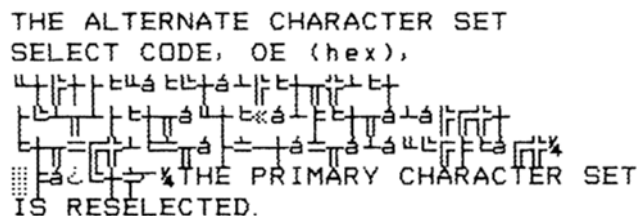

THE ALTERNATE CHARACTER SET  
SELECT CODE, 0E (hex),  
THE PRIMARY CHARACTER SET  
IS RESELECTED.

## Carriage Return

ASCII	CR
Hex	0D
Dec	13

**Purpose** Positions the logical print head at the left margin (resets the memory pointer to the first character position).

**Discussion** The printer can be configured to perform a carriage return only (CR = CR only), or a carriage return plus a line feed function (CR = CR + LF).

A CR = CR configuration enables underline, add, delete, and edit functions, but the host computer must send a separate line feed code to print the data and change the vertical position. The character position indicator is positioned at character column one.

Subsequent printable data preceding a paper motion command replaces previous printable data (including underlines). Two exceptions apply:

- Subsequent underlined characters (hex 5F) overlay the previous data.
- Subsequent space characters (hex 20) only index the character position indicator to the right.

This code can occur at any place in the data stream and is acted upon immediately. Note that this code can reduce the current print speed by up to one-fourth.

With CR = CR + LF, the underline, add, delete and edit functions are disabled, and the code is processed as a line feed. Refer to the Line Feed command description on page 163 for more information.

## Compressed Print

ASCII	SOH	ETX	HT
Hex	01	03	09
Dec	1	3	9

**Purpose** Selects compressed character printing.

**NOTE:** Either SOH, ETX, or HT is defined at the operator panel as the code used to select Compressed Print (the default is SOH). (Refer to the configuration chapter of the *Administrator's Manual*.)

**Discussion** Use the code defined at the operator panel to select 17.1 cpi.

These commands can occur anywhere in the data stream and are acted upon immediately, affecting the entire current print line. Line spacing may be selected either through the operator panel or by line spacing control codes. The control code setting overrides the operator panel line spacing setting.

ETX and HT can also be configured to select Draft font at 10 cpi (see page 165).

### Example:

```
If the Compressed Print option
is installed
control code 01 (hex)
selects the standard compressed (17.1 cpi)
for one line only.
```



## Delete

**ASCII** DEL

**Hex** 7F

**Dec** 127

**Purpose** Delete character puts a blank space at the corresponding character position.

**Discussion** DEL deletes the corresponding character in the print buffer. In Table 51 below, four delete control codes are used to delete DATE from the print line.

**NOTE:** The printer must be configured for carriage return only. If the printer is configured for a carriage return and line feed, the contents of the buffer are printed on receipt of the CR code.

**Table 51 Delete Example**

Enter in Print Buffer	Printed Result
INVOICE DATE(CR) SSSSSSSSDDDD(LF)	INVOICE
<b>Key:</b>	S = Space (hex 20); LF = Line Feed (hex 0A); CR = Carriage Return (hex 0D) D = Delete (hex 7F)

## Electronic Vertical Format Unit (EVFU)

**ASCII** DLE through US

**Hex** 10 through 1F

**Dec** 16 through 31

**Purpose** Load and execute the EVFU.

**NOTE:** PI line is disabled in the above description. ASCII and corresponding codes for EVFU functions differ when the PI line is enabled, according to the printer interface being used.

**Discussion** Information about the EVFU is provided in Chapter 9.

## Elongated Characters (Double High Print)

<b>ASCII</b>	BS	SO
<b>Hex</b>	08	0E
<b>Dec</b>	8	14

**NOTE:** Either BS or SO is defined at the operator panel as the code used to select Elongated Characters (Double High Print). The default is SO. Refer to the configuration chapter of the *Administrator's Manual*.

**Purpose** Selects elongated (double high) character printing for one line.

**Discussion** The Elongated Character control code can be placed anywhere in the data line before the line terminator. Following the line terminator, the printer automatically selects the default font. Consequently, the Elongated Character control code must be sent for each line of elongated characters. Elongated characters cannot be mixed with standard characters on the same print line.

The current line spacing is doubled for one line.

This code can occur anywhere in the data stream and is acted upon immediately. It is cancelled by a SI code or a paper motion command.

### Example

```
Control code 08 (hex) selects
elongated character printing
for one line...
```

```
and then the default print mode
is reselected automatically.
```

## Form Feed

<b>ASCII</b>	FF
<b>Hex</b>	0C
<b>Dec</b>	12

**Purpose** Prints the data in the buffer, advances the paper position to the next top-of-form and moves the logical printhead to the first character column.

**Discussion** The default forms length is determined by the configuration in nonvolatile memory. Forms length is set by using the operator panel or VFU. Code FF cancels all single-line only print attributes.

The default form length is eleven inches. The Form Feed command reacts differently when the VFU is active. More information on VFU is provided in Chapter 9.

## Line Feed

**ASCII** LF

**Hex** 0A

**Dec** 10

**Purpose** Prints the data in the buffer (if any) and advances the vertical character position one line at the current line space setting.

**Discussion** The logical print head is positioned at character column 1 of the new line. The LF function cancels all single line print attributes such as double high (elongated) and double wide (expanded) characters.

In the P-Series XQ Even Dot Plot mode (high density graphics), the LF code does not cause paper position motion; the data in the buffer is plotted and the logical print head is positioned at character column 1 in anticipation of the Odd Dot Plot control code to complete high density graphic plotting.

In the P-Series XQ Odd Dot Plot mode (normal density graphics), the LF code plots the data in the buffer, advances the paper position a single dot row at the current vertical dot density, and positions the logical print head at character column 1.

## Line Spacing (8 or 10.3 LPI)

**ASCII** ACK

**Hex** 06

**Dec** 6

**Purpose** Selects line spacing of 1/8" or 7/72" for current line only.

**NOTE:** The specific line spacing value is selected at the operator panel with the control code 06 parameter. See the *Administrator's Manual* for more information.

**Discussion** The line spacing control code can be placed anywhere in the data stream before the line terminator code; however, it is recommended that you place the line spacing code at the start or end of the data line.

After the line is printed at the new line spacing, the default line spacing is automatically reselected.

### Example

```
The 8 LPI Control Code, 06(hex),
selects 8 lpi spacing
for one line only.
```

## Plot, Even Dot (P-Series XQ High Density Graphics)

**ASCII** EOT

**Hex** 04

**Dec** 4

**Purpose** Selects even dot plot mode to print dots in even numbered dot columns to produce high density plotting.

**Discussion** This control code can occur anywhere in the data line before the line terminator, but for best performance it should be placed at the beginning of the line. This command is acted upon immediately, affecting the entire current print line. It defines certain data between the next and last paper motion commands as even dot plot data. These data are plotted at 60 by 72 dots per inch.

When this mode is exited, the print mode and attributes last selected remain active. A detailed description of plotting can be found in Chapter 8.

## Plot, Odd Dot (P-Series XQ Normal Density Graphics)

**ASCII** ENQ

**Hex** 05

**Dec** 5

**Purpose** Selects odd dot plot mode to print dots in odd numbered dot columns for normal density plotting.

**Discussion** This control code can occur anywhere in the data line before the line terminator, but for best performance it should be placed at the beginning of the line. This command is acted upon immediately, affecting the entire current print line. It defines certain data between the next and last paper motion commands as odd dot plot data. These data are plotted at 60 by 72 dots per inch.

When you exit this mode, the font and attributes last selected remain active. Plotting is described in Chapter 8.

## Select Draft Print

<b>ASCII</b>	STX	ETX	HT
<b>Hex</b>	02	03	09
<b>Dec</b>	2	3	9

**Purpose** Selects Draft 10 cpi as the font.

**NOTE:** Either STX, ETX, or HT is selected at the operator panel as the code that selects High Speed (Draft) Print Mode; the default is STX. (See the Configuration chapter in the *Administrator's Manual*.)

**Discussion** Once the control code for High Speed (Draft) Print Mode has been defined from the operator panel, that code can then select Draft 10 cpi.

These commands can occur anywhere in the data stream and are acted upon immediately, affecting the entire current print line.

ETX and HT can also be configured to select Compressed Print (17.1 cpi) if you configure the printer from the operator panel. (See page 160.)

## Example

```
CONTROL CODE 02 SELECTS  
DRAFT PRINT MODE FOR ONE LINE ONLY  
JUST EXITED DRAFT MODE BY EXECUTING A LF
```

## Space

<b>ASCII</b>	SP
<b>Hex</b>	20
<b>Dec</b>	32

**Purpose** Produces a blank space; no character is printed.

**Discussion** It is not necessary to pad the end of the print line with space characters. The printer automatically fills the line after the line terminator is received.

The Space character code is also used to skip characters for editing and underlining. See Edit Mode on page 157.

## Underline

<b>ASCII</b>	Underline key ( _ )
<b>Hex</b>	5F
<b>Dec</b>	95

**Purpose** Underlines specified character positions.

**Discussion** To underline characters, the print buffer is first loaded with the character line; then the line must be terminated with a Carriage Return code. Spaces are then loaded in the buffer at positions not to be underlined, and the underline code is inserted in the specific positions to be underlined. Table 52 illustrates underlining.

**Table 52 Underline Example**

<b>Enter in Print Buffer</b>	<b>Printed Result</b>
THE 600 PRINTER(CR) SSSS (LF)	THE <u>600</u> PRINTER
<b>Key:</b>	S = Space (hex 20); LF = Line Feed (hex 0A); CR = Carriage Return (hex 0D) _ = Underline (hex 5F)

### **Vertical Tab**

**ASCII** VT

**Hex** 0B

**Dec** 11

**Purpose** Acts as a line terminator when the EVFU is loaded, causing the paper to advance to a specified programmed line.

**Discussion** Vertical Tab is primarily an EVFU line terminator code as described in the Electronic Vertical Format Unit. If the EVFU is not loaded and Vertical Tab control code is used, a single line feed occurs.

# 7 Super-Set Programming

## Introduction

This chapter describes the super-set commands. Super-set commands affect each of the protocols included in the LinePrinter Plus emulation regardless of the printer protocol currently active, except for the P-Series XQ Variant emulation. The commands are sent through the host in the input data stream, and enact the features described in the following subsections.

**NOTE:** The super-set commands do not affect the P-Series XQ Variant emulation.

## Using the Super-Set Commands

Each printer protocol uses a unique control code sequence to introduce the super-set commands, called the Super-Set Control Code (SSCC).

**Table 53 Super-Set Control Codes**

Protocol	SSCC (ASCII Value)	SSCC (Hex Value)
P-Series*	SFCC   } ;	SFCC 7C 7D 3B
P-Series XQ	N/A	N/A
Serial Matrix	ESC   } ;	ESC 7C 7D 3B
Epson FX	ESC   } ;	ESC 7C 7D 3B
Proprinter III XL	ESC   } ;	ESC 7C 7D 3B

\*The SFCC in P-Series is the currently active Special Function Control Code.

**NOTE:** The super-set commands are briefly introduced in the chapters of this book that describe the control codes for each of the emulations listed above.

In the following subsections, the generic code sequence name, SSCC, is placed before the control code to remind you to enter the correct sequence depending on the printer protocol currently active.

### Character Sets

**ASCII Code** SSCC R *n*

**Hex Code** SSCC 52 *n*

**Dec Code** SSCC 82 *n*

**Purpose** Selects one of several character sets.

**Comment** The value of *n* must have three ASCII digits.

**Table 54 Epson FX Character Sets**

<i>n</i>	Character Set	<i>n</i>	Character Set	<i>n</i>	Character Set
000	IBM PC	208	Bulgarian	406	Greek 851
001	Epson Set	209	Win. CP 1251	407	Greek 437
002	OCR-A	210	Latvian 866	408	Greek 8859-7
003	OCR-B	300	Latin 2 8859-2	409	Win. CP 1253
004	Multinational	301	Code Page 852	410	Greek 813 EURO
005	Code Page 850	302	Mazovia	411	EURO 869 EURO
006	CP 858 EURO	303	Kamenicky	500	Hebrew Old
100	ASMO 449	304	Roman 8	501	Hebrew New
101	ASMO 449+	305	PC-437 Slavic	502	Hebrew DEC
102	ASMO 708	306	Slavic 1250	503	Latin-1 Hebrew
103	ASMO 708+	307	Code Page 865	504	Win. CP 1255
104	MS DOS CP710	308	Code Page 860	600	Data Gen. Turk.
105	MS DOS CP720	309	Latin 1 8859-1	601	DEC Turkish
106	Sakr CP714	310	Latin 5 8859-9	602	IBM Turkish
107	Aptec CP715	311	Latin 9 8859-15	603	Siemens Turkish
108	CP 786	312	Polish POL1	604	PTT Turkish
109	Arabic CP 864	313	Win. CP 1250	605	IBC Turkish
110	Arabic CP 1046	314	Win. CP 1252	606	Bull Turkish
111	Arabic Lam 1	315	Win. CP 1257	607	AS400 Turkish
112	Arabic Lam 2	316	CP 858 EURO	608	Unisys Turkish
113	Win. CP 1256	317	Lith. CP 773	609	NCR Turkish
114	Farsi 1	318	Serbo Croatian 1	610	PST Turkish
115	Farsi 2	319	Serbo Croatian 2	611	Unis-1 Turkish
116	1098 Farsi 1285	320	CP 774	612	Code Page 853
200	Cyrillic 866	321	CP 775	613	INFO Turkish
201	Cyrillic CP 437	322	ISO 8859-4	614	Win. CP 1254
202	Cyrillic 113	400	DEC 256 Greek	615	Code Page 857
203	Cyrillic 8859-5	401	ELOT 928 Greek	616	Azeri
204	ISO 915	402	Greek 3	700	Block-Set 10cpi
205	Code Page 855	403	ABY Greek	701	Italics Set
206	7 Bit Cyrillic	404	ABG Greek	702	Scanblock 10cpi
207	Ukrainian	405	ELOT 927 Greek	703	PGL Thai Set



**Table 55 P-Series and Serial Matrix Character Sets**

<i>n</i>	Character Set	<i>n</i>	Character Set	<i>n</i>	Character Set
000	IBM PC	210	Latvian 866	408	Greek 8859-7
001	Multinational	300	Latin 2 8859-2	409	Win. CP 1253
002	EMCA Latin 1	301	Latin 2 852	410	Greek 813 EURO
003	DEC Mult.	302	Mazovia	411	Greek 869 EURO
004	CP 858 EURO	303	Kamenicky	500	Hebrew Old
100	ASMO 449	304	Roman 8	501	Hebrew New
101	ASMO 449+	305	PC-437 Slavic	502	Hebrew DEC
102	ASMO 708	306	Slavic 1250	503	Latin-1 Hebrew
103	ASMO 708+	307	Code Page 865	504	Win. CP 1255
104	MS DOS CP 710	308	Code Page 860	600	Data Gen. Turk.
105	MS DOS CP 720	309	Latin 1 8859-1	601	DEC Turkish
106	Sakr CP714	310	Latin 5 8859-9	602	IBM Turkish
107	Aptec CP715	311	Latin 9 8859-15	603	Siemens Turkish
108	CP 786	312	Polish POL1	604	PTT Turkish
109	IBM CP 864	313	Win. CP 1250	605	IBC Turkish
110	IBM CP 1046	314	Win. CP 1252	606	Bull Turkish
111	Arabic Lam 1	315	Win. CP 1257	607	AS400 Turkish
112	Arabic Lam 2	316	CP 858 EURO	608	Unisys Turkish
113	Win. CP 1256	317	Lith CP 773	609	NCR Turkish
114	Farsi 1	318	Serbo Croatian 1	610	PST Turkish
115	Farsi 2	319	Serbo Croatian 2	611	Unis-1 Turkish
116	1098 Farsi 1285	320	CP 774	612	Code Page 853
200	Cyrillic 866	321	CP 775	613	INFO Turkish
201	Cyrillic CP 437	322	ISO 8859-4	614	Win. CP 1254
202	Cyrillic 113	400	DEC 256 Greek	615	Code Page 857
203	Cyrillic 8859-5	401	ELOT 928 Greek	616	Azeri
204	ISO 915	402	Greek 3	700	Block-Set 10cpi
205	Code Page 855	403	ABY Greek	701	Italics Set
206	Cyrillic 7 Bit	404	ABG Greek	702	Scanblock 10cpi
207	Ukranian	405	ELOT 927 Greek	703	PGL Thai Set
208	Bulgarian	406	Greek 851		
209	Win. CP 1251	407	Greek 437		

**Table 56 Proprinter XL Character Sets**

<i>n</i>	Character Set	<i>n</i>	Character Set	<i>n</i>	Character Set
000	Code Page 437	209	Win. CP 1251	407	Greek 437
001	Code Page 850	210	Latvian 866	408	Greek 8859-7
002	OCR-A	300	Latin 2 8859-2	409	Win. CP 1253
003	OCR-B	301	Code Page 852	410	Greek 813 EURO
004	Multinational	302	Mazovia	411	Euro 869 EURO
005	CP 858 EURO	303	Kamenicky	500	Hebrew Old
100	ASMO 449	304	Roman 8	501	Hebrew New
101	ASMO 449+	305	PC-437 Slavic	502	Hebrew DEC
102	ASMO 708	306	Slavic 1250	503	Latin-1 Hebrew
103	ASMO 708+	307	Code Page 865	504	Win. CP 1255
104	MS DOS CP710	308	Code Page 860	600	Data Gen. Turk
105	MS DOS CP720	309	Latin 1 8859-1	601	DEC Turkish
106	Sakr CP714	310	Latin 5 8859-9	602	IBM Turkish
107	Aptec CP715	311	Latin 9 8859-15	603	Siemens Turkish
108	CP 786	312	Polish POL1	604	PTT Turkish
109	IBM 864	313	Win. CP 1250	605	IBC Turkish
110	IBM 1046	314	Win. CP 1252	606	Bull Turkish
111	Arabic Lam 1	315	Win. CP 1257	607	AS400 Turkish
112	Arabic Lam 2	316	CP 858 EURO	608	Unisys Turkish
113	Win. CP 1256	317	Lith. CP 773	609	NCR Turkish
114	Farsi 1	318	Serbo Croatic 1	610	PST Turkish
115	Farsi 2	319	Serbo Croatic 2	611	Unis-1 Turkish
116	1098 Farsi 1285	320	CP 774	612	Code Page 853
200	Cyrillic 866	321	CP 775	613	INFO Turkish
201	Cyrillic CP 437	322	CP 8859-4	614	Win. CP 1254
202	Cyrillic 113	400	DEC 256 Greek	615	Code Page 857
203	Cyrillic 8859-5	401	ELOT 928 Greek	616	Azeri
204	ISO 915	402	Greek 3	700	Block-Set 10cpi
205	Code Page 855	403	ABY Greek	701	Italics Set
206	Cyrillic 7 Bit	404	ABG Greek	702	Scanblock 10cpi
207	Ukrainian	405	ELOT 927 Greek	703	PGL Thai Set
208	Bulgarian	406	Greek 851		

## Character Set Selection (UTF8)

<b>ASCII Code</b>	SSCC R C
<b>Hex Code</b>	SSCC 52 C
<b>Dec Code</b>	SSCC 82 C
<b>Purpose</b>	Selects the UTF-8 character set. C = UTF
<b>Example</b>	SSCC R UTF

## Character Spacing $n/240$ Inch

<b>ASCII Code</b>	SSCC I $n$ (uppercase "i")
<b>Hex Code</b>	SSCC 49 $n$
<b>Dec Code</b>	SSCC 73 $n$
<b>Purpose</b>	Specifies the character spacing in $n/240$ -inch increments.
<b>where:</b>	$n = 001$ through $999$ (three ASCII digits)
<b>Comment</b>	When the $n/240$ -inch character spacing command is received, all character printing will be at $n/240$ -inch horizontal spacing until a new character spacing is selected.

## Font Selection

<b>Syntax:</b>	SSCC S $n_1 ; n_2 ; n_3 ; n_4 ; n_5 ; n_6$
<b>Purpose:</b>	Selects character height and width independently for the selected font.
<b>Comment:</b>	Parameters $n_1$ through $n_6$ are specified as ASCII digit (numeral) values. To keep a parameter value unchanged, use the character "x" in place of the parameter for every digit of the parameter's width. All parameters must be present, and all digits in the defined field width must be used. There are no spaces between parameters; the parameters are separated by semicolons as shown.

### Font Selection Command:

The font selection command is the letter "S," which is decimal 83 or hex 0x53. This command character is followed by the font number, with no space, semicolon, or other character in between.

### Parameters:

<b>where:</b>	$n_1 =$ FONT NUMBER
	Takes five ASCII numeral characters as a parameter. The font number for the P8000 printers can be "93779" (Letter Gothic), "93952" (Courier), "90993" (OCR-A), or "91409" (OCR-B).
<b>where:</b>	$n_2 =$ BOLD
	Takes a single ASCII numeral character as a parameter. Use "1" to enable bold print or "0" to disable bold.

**where:** n3 = SLANT  
 Takes a single ASCII numeral character as a parameter. Use "1" for a right-hand slant, or use "2" for a left-hand slant. Use "0" to print upright characters with no slant.

**where:** n4 = CHARACTER SET  
 Takes three ASCII numeral characters as a parameter. See Table 54, Table 55, and Table 56 for a list of the characters. If the default character set is used, enter the character "x" in place of the parameter for every digit of the parameter's width. See the ASCII example on page 172.

**where:** n5 = WIDTH  
 Takes four ASCII numeral characters as a parameter. The width parameter defines the width of the character cell in 1/480 inch increments. The character cell holds the printed character and some intercharacter spacing. Parameter "0048" selects 10 cpi text. If the default character set is used, enter the character "x" in place of the parameter for every digit of the parameter's width. See the ASCII example on page 172.

**where:** n6 = HEIGHT  
 Takes four ASCII numeral characters as a parameter. The height parameter defines the height of the character cell in 1/288 inch increments, or quarter-points. The character cell holds the printed character including descenders and underline, and some interline spacing. Parameter "0048" selects 6 lpi vertical spacing. If the default character set is used, enter the character "x" in place of the parameter for every digit of the parameter's width. See the ASCII example on page 172.

**NOTE:** This command positions the character cell so the character "baseline" is at the current print position. The baseline forms the bottom margin for uppercase characters, with 7/12 of the cell height above the baseline, and 5/12 of the cell height below it. This means that if expanded characters are started too close to the top of the page, the characters will be cut off at the top. Also, if expanded characters are started too close to the bottom of the page, characters could be cut off or may force an extra blank page to print. Care should be taken when positioning expanded characters to insure the entire character cell will fit on the page.

**Example:** P-Series emulation, font = "Letter Gothic," bold, upright, no change to character set, 10 cpi, double-high

**ASCII:** "\_|};S93779;1;0;xxx;0048;0096"

**Hexadecimal:** "01 7C 7D 3B 53 39 33 37 37 39 3B 31 3B 30 3B 78 78 78 3B 30 30 34 38 3B 30 30 39 36"

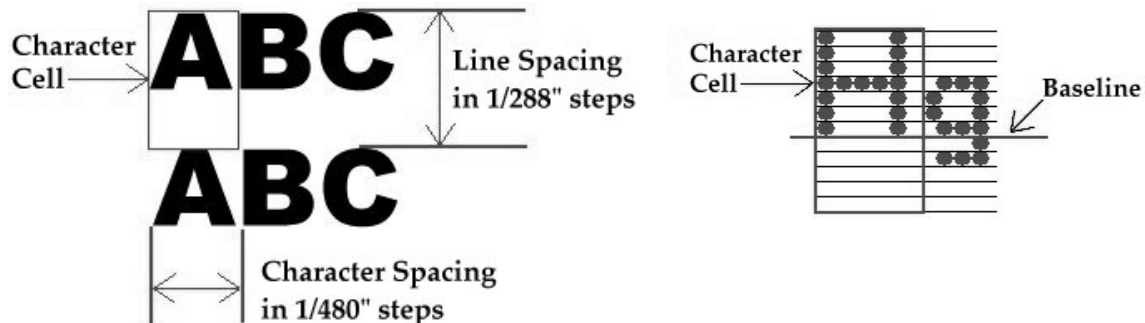

**Figure 3 Character Cell Dimensions**

### More About Width:

Refer to Figure 3. The width parameter defines the width of the character cell in increments of 1/480 inch. The cell width is the distance from the left edge of a character to the left edge of the next character, including whatever intercharacter spacing is present in the font. Expanded characters are modeled on the default 10 cpi font, which has an intercharacter spacing of approximately 1/6 the total width of the cell.

To calculate a width parameter for a monospaced font, divide 480 by the desired value of "cpi" (characters per inch), or multiply 480 by the width of a cell in inches. For example, for 10 cpi text, calculate (480/10) to get a parameter of "0048." To create characters which print 1/4 inch wide, calculate (480 \* 1/4) to get a parameter of "0120."

$$\frac{480}{\text{Chars per Inch}} = \text{Parameter} \quad 480 * (\text{Cell width in inches}) = \text{Parameter}$$

### More About Height:

Refer to Figure 3. The height parameter defines the height of the character cell in increments of 1/288 inch, or quarter-points. The cell height includes room for the printed character, a descender or underline if present, and some blank dot rows to improve readability between lines.

Note that the height parameter sets the height of the cell, which can be nearly twice the height of the printed character itself. The height of a character is in proportion to a standard uppercase character that is 1/10 inch wide and 1/10 inch tall, in a cell that is 1/6 inch tall. The standard character as produced on an impact printer is composed of dots 1/72 inch tall, so the standard cell is 12 dots tall (12/72 inch = 1/6 inch) with an uppercase character printing in the top 7 dot rows. This font command maintains those proportions for all monospaced fonts. For example, double-high uppercase text prints 14/72 inch tall in a cell that is 1/3 inch tall (or 24/72 inch), and so forth.

To calculate the parameter for vertical line spacing, divide 288 by the desired value of "lpi" (lines per inch). To calculate a parameter for character cell height, multiply 288 by the height of the character cell.

$$\frac{288}{\text{Lines per Inch}} = \text{Parameter} \quad 288 * (\text{Cell height in inches}) = \text{Parameter}$$

For example, to print at 6 lpi, a parameter of (288/6) or "0048" is needed. To create a cell that is two inches tall, multiply 288 by 2 inches to get a parameter of "0576."

The preceding equations are used to set the cell height. To find the height of a cell that has a specific character height, multiply 494 by the character size in inches. The value of 494 is 288 multiplied by (12/7), which is the ratio of cell height to character height.

For example, to print 1/2 inch tall uppercase characters, calculate (494 \* 0.5 inches) to get a parameter of "0247." The cell size for 1/2 inch tall characters is approximately 0.9 inch tall. In other words, 1/2 inch tall text will print at approximately 1.1 lines per inch.

As a final example, to print upper- and lowercase text so that the overall height from cell-top to descenders is 1/2 inch, first note that uppercase height plus descenders is 9/12 of the cell height. Then 288 \* (12/9) is 384, and the parameter to use is (384 \* 1/2) or "0192." This text will print at 1.5 lines per inch, or 288/192.

## Cell Baseline and Cell Height:

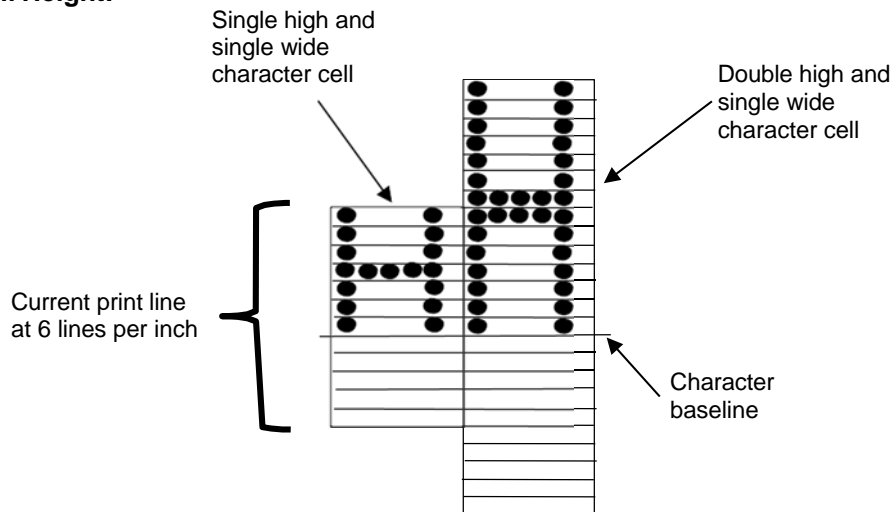

**NOTE:** The double-high character cell extends both above and below the current print line.

**Figure 4 Expanded Character Cells and Character Baseline**

Characters line up along the “baseline” of the print line. Uppercase characters have their bottom dot row on the baseline. The default character cell is a single-high uppercase character at 6 lines per inch, which prints in the top 7 dot rows of a cell 12 dot rows tall. Expanded character cells all have the same proportions, so that the character baseline is always located 7/12 of the way down the cell.

The cell baselines are always aligned on every print line, so that all characters printed on that line will line up along the bottom edge of the characters, for all vertical expansions. Figure 4 shows a single-high character printed next to a double-high character. Both characters line up their bottom edges against the baseline. The double-high character cell is shown extending both above and below the current print line. The upper part of the character will print on the previous line, which may cause problems if it extends to the previous page; also, the P8000 printers will open the platen and reverse paper in order to print on the previous line. The lower part of the cell is blank, but it still affects line spacing. The double-high character shown will cause the printer to double-space automatically; also, printers may eject a blank page if the part of the cell below the baseline overlaps the bottom of the current page.

The blank area below the printed character can be as much as 5/12 of the total cell height. This affects the maximum height of text printed using this method, because any character that is much more than half as high as the page may cause an extra blank page to be ejected when printing.

### Notes:

- Printing expanded characters on the P8000 printer family will cause the printer to open the platen and reverse paper, because all characters taller than single-height will print at least some dots on the previous line. This causes a reduction in printing speed.
- The P8000 printer cannot produce arbitrarily short characters. The minimum height of a printed uppercase character on the P8000 is 7/72 inch or approximately one-tenth of an inch tall. The cell height can be set with a parameter smaller than 0048, which will affect the lines-per-inch value but not the printed height of the characters.

- The P8000 printer cannot produce a character height between single-high and double-high. That is, all vertical expansions of 0048 and less will result in a 1/10 inch tall printed character. All vertical expansions between 0049 and 0096 will result in a 2/10 inch tall printed character. Expansions greater than 0096 will be scaled as close to the indicated height as possible. The impact printer dots are 1/72 inch tall, which is 4/288 inch, so select height parameters that are multiples of 4.
- Be careful when positioning expanded character cells, so they do not print over a page boundary. The character baseline is always 7 dots from the top of the current print position. An expanded character will have some of its cell defined above the current print line, and some below. Some of the characters may be cut off or blank pages may be ejected if the cell overlaps the previous or following pages, depending on the cell size and the starting row.

### TrueType Font Selection

- Syntax:** SSSC ) *n*;
- Purpose:** Selects the TrueType font where *n* is the fontname.ext.
- Example:** ESC | } ; ) arial.ttf;
- Discussion:** The “|” in the command string is the pipe symbol.

### Line Spacing *n*/288 Inch

- ASCII Code** SSSC L *n*
- Hex Code** SSSC 4C *n*
- Dec Code** SSSC 76 *n*
- Purpose** Specifies the line spacing in *n*/288-inch increments.
- where:** *n* = 0001 through 9999 (four ASCII digits)
- Comment** When the *n*/288-inch line spacing command is received, all character printing will be at *n*/288-inch vertical spacing until a new line spacing is selected.

### Printer Protocol Select

- ASCII Code** SSSC P *n*
- Hex Code** SSSC 50 *n*
- Dec Code** SSSC 80 *n*
- Purpose** Selects (changes) printer protocol.
- Comment** When the emulation receives this command, a software reset is performed as if the emulation were powered-up in the corresponding protocol. If the paper is not at Top Of Form (TOF) when this command is received, the printer will move the paper to the next TOF. If the paper is already at TOF, no paper motion will occur.

**Table 57 Printer Protocol Select**

<i>n</i> (hex)	Protocol
00 or 30	P-Series
01 or 31	P-Series XQ
02 or 32	Serial Matrix
03 or 33	Proprinter III XL
04 or 34	Epson FX

The printer protocol may also be selected from the control panel.

**NOTE:** If P-Series XQ is selected, then you cannot use this command to exit the protocol.

## Barcodes

A barcode is a graphic representation of alphanumeric characters. The LinePrinter Plus barcodes are listed below, with detailed barcode information and examples provided on the referenced pages. All parameters must be separated by a semicolon (;) unless noted otherwise. Throughout this chapter, actual commands required for input are shown exactly as they must be entered, while all parameters associated with that command are shown in italics. Optional parameters are enclosed in brackets.

Spaces are used only to visually separate the command parameters, but *do not* enter these spaces in your command.

The single most important consideration when printing a bar code is to ensure the bar code will be scanned properly. Incorporating a bar code quality procedure in the printing process is the best way to ensure that bar codes are being printed correctly. A properly implemented verification procedure will increase overall bar code quality, reduce waste from misprinted bar codes, and achieve high first-time read rates, which is an increasingly important factor in newer, more efficient systems where manually entered data is not acceptable as a backup function. Verification also minimizes the costs of returned products due to poor reading or unaccountable bar codes. RJS designs and manufactures the world's most complete line of bar code verification products, including their portable Inspector and Laser Inspector models, On-Line Inspector and AutoScan II series. For more information on RJS bar code verifiers, contact their corporate headquarters at 763-746-8034, or visit their web site at [www.rjs1.com](http://www.rjs1.com).



**Table 58 Available Barcodes**

<b>Barcode</b>	<b>Mnemonic</b>	<b>Symbol Length</b>	<b>Code Set</b>	<b>Page Number</b>
Codabar	SSCC c B	Variable	Alphanumeric	181
Code 39	SSCC c C	Variable	Alphanumeric	183
Code 93	SSCC c 9	Variable	Alphanumeric	185
Code 128	SSCC c D	Variable	Alphanumeric	187
EAN 8	SSCC c 8	7 digits	Numeric	191
EAN 13 <sup>1</sup>	SSCC c 1	12 digits	Numeric	192
FIM	SSCC c F	n/a	A, B, C or D	193
German I-2/5	SSCC c G	11 or 13 digits	Numeric	196
Intelligent Mail 4-State	SSCC c 6	20, 25, 29, or 31 digits	Alphanumeric	195
Interleaved 2/5 <sup>2</sup>	SSCC c I	Variable	Numeric	196
MSI	SSCC c M	13 or 14 digits	Numeric	197
PDF 417	SSCC c 4	Variable	Alphanumeric	198
PostBar <sup>3</sup>	SSCC c O	Variable	0-3	199
POSTNET	SSCC c P	5, 9 or 11 digits	Numeric	200
Royal Mail	SSCC c R	Variable	Alphanumeric	199
Telepen	SSCC c T	Variable	Alphanumeric	202
UCC/EAN-128	SSCC c V	Variable	Numeric	203
UPC-A	SSCC c A	11 digits	Numeric	207
UPC-E	SSCC c E	11 digits	Numeric	208
UPC Shipping	SSCC c S	13 digits	Numeric	211
UPS 11	SSCC c U	10 digits	Alphanumeric	212

**NOTES:**

<sup>1</sup>The barcode type is the numeral one: "1."

<sup>2</sup>The "I" in the Interleaved 2/5 mnemonic is the uppercase "I" ASCII character.

<sup>3</sup>The barcode type is the uppercase letter "O."

## Barcode Format

**ASCII Code**   SSCC *c t*; *d data d* [; *N n*; *xxxx*; *yyyy*] [; *X mmmm*] [; *P p*] [; *C*] [; *H hh*] [; *D*]  
**Hex Code**     SSCC 63 *t*; *d data d* [; 4E *n*; *xxxx*; *yyyy*] [; 58 *mmm*] [; 50 *p*] [; 43] [; 48 *hh*] [; 44]  
**Dec Code**     SSCC 99 *t*; *d data d* [; 78 *n*; *xxxx*; *yyyy*] [; 88 *mmm*] [; 80 *p*] [; 67] [; 72 *hh*] [; 68]  
**Purpose**        Invokes barcodes.  
**Comment**     These barcodes cannot be rotated or scaled.

If there is a printable data field in the barcode specification, it will print in the DP font; except for UPC-A and UPC-E which print in OCR B.

Bar codes cannot be positioned beyond the bottom or right end of the currently defined logical form. The command syntax prevents positioning the cursor above the current position or to the left of the form. Drawing a barcode causes the printer to automatically switch to DP print mode.

The DP print mode is active until the bottom of the barcode has been printed. After this, you can change the print mode. You can change the print mode to OCR A, OCR B or back to DP between the current cursor location and the bottom of the barcode position. Print mode changes to NLQ or HS will be ignored in this region.

**where:**        *t* = type of barcode (see Table 59).

**Table 59 Barcode Selection Values**

<i>t</i> (ASCII)	<i>t</i> (hex)	Selects Barcode
B	42	Codabar
C	43	Code 39
9	39	Code 93
D	44	Code 128
8	38	EAN-8
1	31	EAN-13
F	46	FIM
G	47	German I-2/5
I	49	Interleaved 2/5
M	4D	MSI
4	34	PDF 417
O	4F	PostBar
P	50	POSTNET
R	52	Royal Mail
T	54	Telepen
V	56	UCC/EAN-128
A	41	UPC-A
E	45	UPC-E
S	53	UPC Shipping
U	55	UPS 11

**NOTE:** For all of the following parameters, the digits are ASCII values.

**where:**  $d$  = the barcode delimiter, which can be any character not used in the barcode data field

**where:**  $data$  = variable length printable data field

The following parameters are optional:

**where:**  $N$  = activates the offset

**where:**  $n$  = the x and y coordinate unit system (see Table 60)

**Table 60 Offset Unit Select**

$n$ (ASCII)	Selects Value
0	use current cpi and lpi values
1	use 1/4 inch value
2	use 1/2 centimeter value: $1/(2.54 \times 2)$
3	use 1 millimeter value: $1/(25.4)$
4	use DP dot value (hor. 1/120" x vert. 1/72")

**where:**  $xxxx$  = four-digit upper left corner x (horizontal axis)

**where:**  $yyyy$  = four-digit upper left corner y (vertical axis)

**where:**  $X$  = activates magnification

**where:**  $mmm$  = magnification value. Valid values are X1, X1.5, X1A, X1B, X2, X2A, X3 and X4.

**where:**  $P$  = activates printable data field variable

**where:**  $p$  = location of printable data field (see Table 61)

**Table 61 Printable Data Field Location**

$p$ (ASCII)	$p$ (hex)	Selects Location
A	41	above
B	42	below (default)
N	4E	none

**where:**  $C$  = calculate and plot check digit (if available as an option)

The default is no check digit if the check digit is allowed to be optional.

**where:**  $H$  = activates the height variable

**where:**  $hh$  = two-digit barcode height in 1/10". The default is as specified in the individual barcode specifications.

**where:**  $D$  = activates dark barcode

### Comment

The x and y values are added to the current cursor position. You cannot specify the upper left corner to be above the current print position.

If  $xxxx = 0000$  and  $yyyy = 0000$  and there are no line feeds, any text following the barcode command will print next to the barcode. Notice that the x horizontal cursor position is automatically updated. See Figure 5.

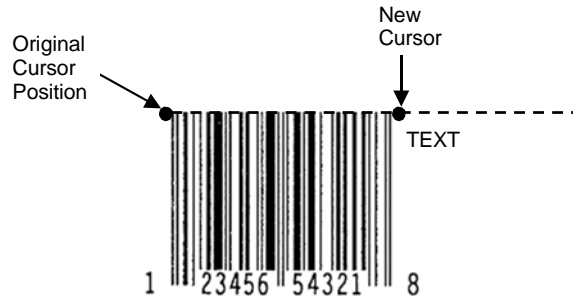

Figure 5 Barcode Example 1

However, if the values are other than 0000, the original cursor position remains intact, despite the printing of the barcode. See Figure 6, which shows  $xxxx = 10$  and  $yyyy = 5$ .

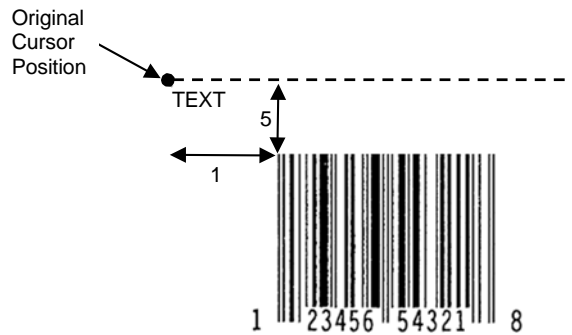

Figure 6 Barcode Example 2

To place the text below the barcode, you must insert line feed commands. See Figure 7.

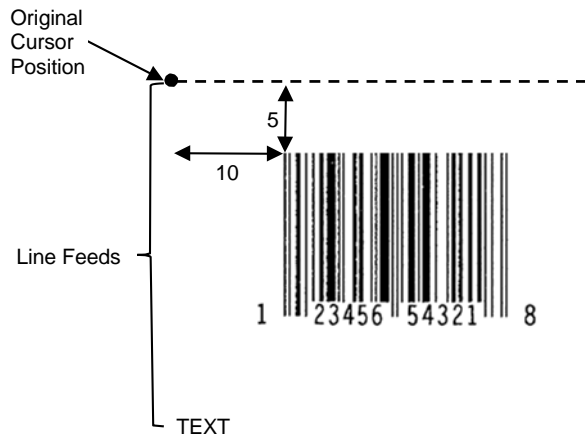

Figure 7 Barcode Example 3

**IMPORTANT** Consecutive barcode commands must be terminated by line feeds.

```
ESC | } ; cF ; xCx ; N0 ; 0065 ; 0001 ; H01 <LF>  
ESC | } ; cP ; x481701892x ; N0 ; 0050 ; 0020 ; H09
```

## Codabar

The Codabar structure is shown in Figure 8 and described below.

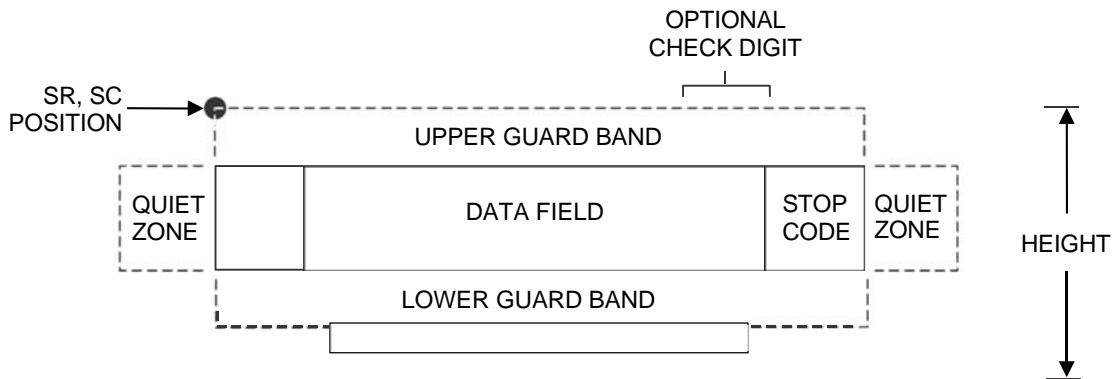

**Figure 8 Codabar Structure**

### Quiet Zone

Both ends of the bar code structure require blank quiet zones. The quiet zones must be at least 0.25 inches wide and completely blank to ensure accurate reading of the start/stop codes and to prevent adjacent bar codes from overlapping. Be sure to provide sufficient space on the form for the quiet zones.

### Start/Stop Codes

The start/stop code is a unique character identifying the leading and trailing end of the bar code. The start/stop code is automatically produced with each bar code. The start/stop code structure permits bidirectional bar code scanning.

### Data Field

The bar code symbol uses a series of wide and narrow bars and spaces to represent standard alphanumeric characters. Each wide or narrow bar or space is one element; each character in the data field has nine elements. The structure is three wide elements (bars or spaces) out of the nine total elements which compose one character.

### Readable Data

The optional readable data field provides a readable interpretation of the bar code data. It can be printed above or below the bar code symbol.

### Check Digit

The optional modulo-43 check digit can be inserted into the bar code to verify accurate scanning.

**Table 62 Codabar Character Set**

<b>Character</b>	<b>Hex</b>	<b>Character</b>	<b>Hex</b>
0	0	\$	24
1	1	:	3A
2	2	/	2F
3	3	.	2E
4	4	+	2B
5	5	A	41
6	6	B	42
7	7	C	43
8	8	D	44
9	9	-	2D

## Code 39

The Code 39 structure is shown in Figure 9 and described below.

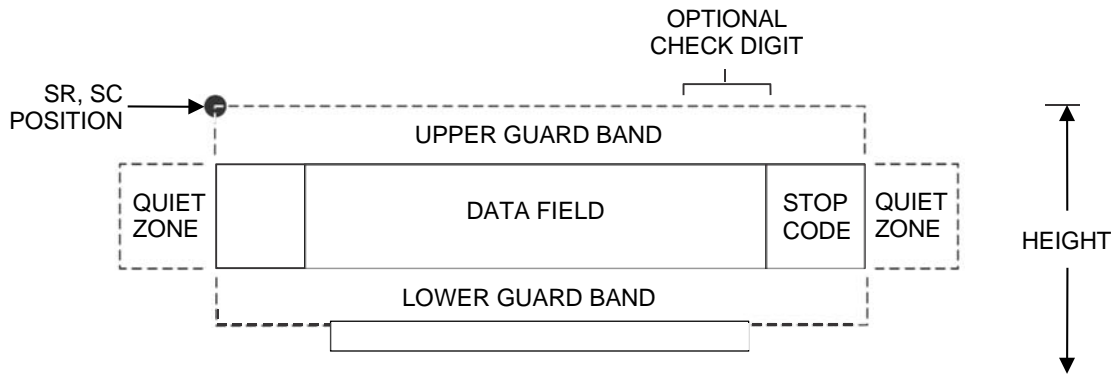

**Figure 9 Code 39 Structure**

### Quiet Zone

Both ends of the barcode structure require blank quiet zones. The quiet zones must be at least 0.25 inches wide and completely blank to ensure accurate reading of the start/stop codes and to prevent adjacent barcodes from overlapping. Be sure to provide sufficient space on the form for the quiet zones.

### Start/Stop Codes

The start/stop code is a unique character identifying the leading and trailing end of the barcode. The start/stop code is automatically produced with each barcode. The start/stop code structure permits bidirectional barcode scanning.

### Data Field

The barcode symbol uses a series of varying width bars and spaces to represent standard alphanumeric characters. Each wide or narrow bar or space is one element; each character in the data field has nine elements. The structure is three wide elements (bars or spaces) out of the nine total elements which compose one character.

### Readable Data

The optional readable data field provides a readable interpretation of the barcode data. It can be printed above or below the barcode symbol.

### Check Digit

The optional modulo-43 check digit can be inserted into the barcode to verify accurate scanning.

Table 63 Code 39 Character Set

ASCII	CODE 39	ASCII	CODE 39	ASCII	CODE 39	ASCII	CODE 39
NUL	%U	SP	Space	@	%V	`	%W
SOH	\$A	!	/A	A	A	a	+A
STX	\$B	"	/B	B	B	b	+B
ETX	\$C	#	/C	C	C	c	+C
EOT	\$D	\$	/D	D	D	d	+D
ENQ	\$E	%	/E	E	E	e	+E
ACK	\$F	&	/F	F	F	f	+F
BEL	\$G	'	/G	G	G	g	+G
BS	\$H	(	/H	H	H	h	+H
HT	\$I	)	/I	I	I	i	+I
LF	\$J	*	/J	J	J	j	+J
VT	\$K	+	/K	K	K	k	+K
FF	\$L	,	/L	L	L	l	+L
CR	\$M	—	—	M	M	m	+M
SO	\$N	.	/N	N	N	n	+N
SI	\$O	/	/O	O	O	o	+O
DLE	\$P	0	0	P	P	p	+P
DC1	\$Q	1	1	Q	Q	q	+Q
DC2	\$R	2	2	R	R	r	+R
DC3	\$S	3	3	S	S	s	+S
DC4	\$T	4	4	T	T	t	+T
NAK	\$U	5	5	U	U	u	+U
SYN	\$V	6	6	V	V	v	+V
ETB	\$W	7	7	W	W	w	+W
CAN	\$X	8	8	X	X	x	+X
EM	\$Y	9	9	Y	Y	y	+Y
SUB	\$Z	:	/Z	Z	Z	z	+Z
ESC	%A	;	%F	[	%K	{	%P
FS	%B	<	%G	\	%L		%Q
GS	%C	=	%H	]	%M	}	%R
RS	%D	>	%I	^	%N	~	%S
US	%E	?	%J	—	%O	DEL	%T %X %Y %Z

**NOTE:** Character pairs /M, /N, and /P through /Y are reserved for future control character pairs.



## Code 93

The Code 93 bar code structure is shown in Figure 10 and described below.

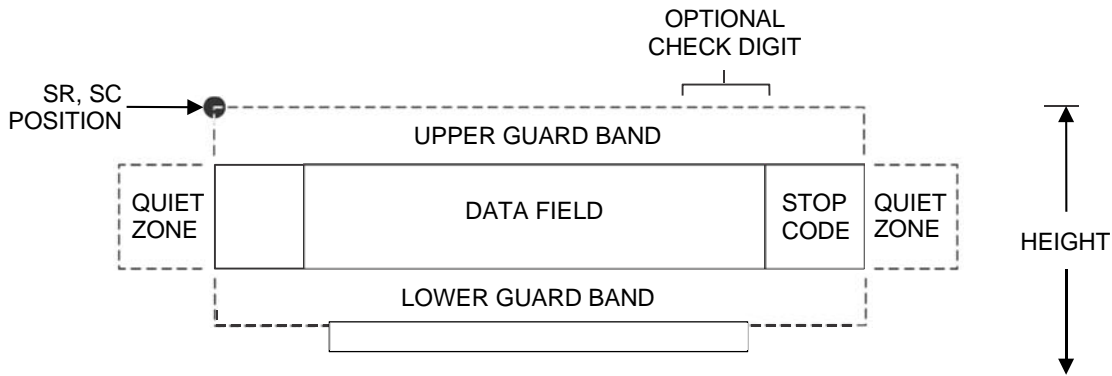

**Figure 10 Code 93 Structure**

### Quiet Zone

Both ends of the bar code structure require blank quiet zones. The quiet zones must be at least 0.25 inches wide and completely blank to ensure accurate reading of the start/stop codes and to prevent adjacent bar codes from overlapping. Be sure to provide sufficient space on the form for the quiet zones.

### Start/Stop Codes

The start/stop codes identify the leading and trailing end of the bar code.

### Code 93 Data Field

The bar code symbol uses a series of varying width bars and spaces to represent an extensive character set. The bars and spaces vary in width from one to four modules. Each character consists of three bars and three spaces that total 11 modules.

### Readable Data

The optional readable data field provides a readable interpretation of the bar code data. It can be printed above or below the bar code symbol.

### Check Digit

The modulo-103 check digit is automatically calculated and inserted in the bar code symbol. The check digit verifies accurate scanning. The start code is included in the check digit algorithm.

**Table 64 Code 93 Character Set**

Character	Hex	Character	Hex
0	0	P	50
1	1	Q	51
2	2	R	52
3	3	S	53
4	4	T	54
5	5	U	55
6	6	V	56
7	7	W	57
8	8	X	58
9	9	Y	59
A	41	Z	5A
B	42	-	2D
C	43	.	2E
D	44	SPACE	20
E	45	\$	3F
F	46	/	2F
G	47	+	2B
H	48	%	25
I	49	S1	n/a
J	4A	S2	n/a
K	4B	S3	n/a
L	4C	S4	n/a
M	4D	Start	n/a
N	4E	Stop	n/a
O	4F		

## Code 128

The Code 128 structure is shown in Figure 11 and described below.

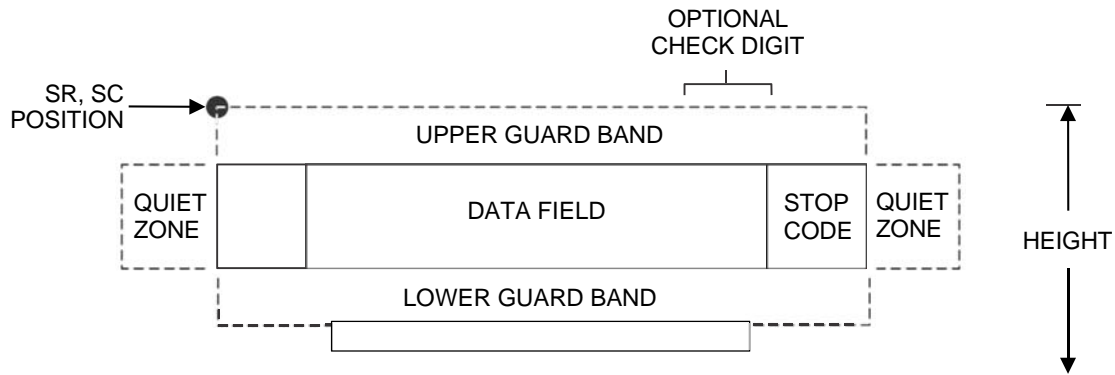

**Figure 11 Code 128 Structure**

### Quiet Zone

Both ends of the bar code structure require blank quiet zones. The quiet zones must be at least 0.25 inches wide and completely blank to ensure accurate reading of the start/stop codes and to prevent adjacent bar codes from overlapping. Be sure to provide sufficient space on the form for the quiet zones.

### Start/Stop Codes

The start/stop codes identify the leading and trailing end of the bar code. Each of the Code 128 subsets uses a unique start code and a common stop code, both automatically provided by LP+.

### Code 128A Data Field

Subset A operates in the manual mode only. Subset A data characters include mostly normal printable ASCII characters which require no subset switching and can be entered directly.

### Code 128B Data Field

The bar code symbol uses a series of varying width bars and spaces to represent an extensive character set (96 ASCII characters and seven control characters). The bars and spaces vary in width from one to four modules. Each character consists of three bars and three spaces that total 11 modules.

### Code 128C Data Field

The bar code symbol uses a series of varying width bars and spaces to represent 100 pairs of numeric digits (00 through 99) and 3 control characters. The bars and spaces vary in width from 1 to 4 modules. Each character consists of three bars and three spaces that total 11 modules.

### Readable Data

The optional readable data field provides a readable interpretation of the bar code data. It can be printed above or below the bar code symbol.

### Check Digit

The modulo-103 check digit is automatically calculated and inserted in the bar code symbol. The check digit verifies accurate scanning. The start code is included in the check digit algorithm.

Table 65 Code 128A Character Set

Character	Hex	Character	Hex	Character	Hex	Character	Hex
NUL	00	SUB	1A	4	34	N	4E
SOH	01	ESC	1B	5	35	O	4F
STX	02	FS	1C	6	36	P	50
ETX	03	GS	1D	7	37	Q	51
EOT	04	RS	1E	8	38	R	52
ENQ	05	US	1F	9	39	S	53
ACK	06	SP	20	:	3A	T	54
BEL	07	!	21	;	3B	U	55
BS	08	"	22	<	3C	V	56
HT	09	#	23	=	3D	W	57
LF	0A	\$	24	>	3E	X	58
VT	0B	%	25	?	3F	Y	59
FF	0C	&	26	@	40	Z	5A
CR	0D	'	27	A	41	[	5B
SO	0E	(	28	B	42	\	5C
SI	0F	)	29	C	43	]	5D
DLE	10	*	2A	D	44		5E
DC1	11	+	2B	E	45	^	5F
DC2	12	,	2C	F	46	FNC 3	23 See NOTE
DC3	13	-	2D	G	47	FNC 2	22 See NOTE
DC4	14	.	2E	H	48	SHIFT	28 See NOTE
NAK	15	/	2F	I	49	CODE C	27 See NOTE
SYN	16	0	30	J	4A	FUNC 4	24 See NOTE
ETB	17	1	31	K	4B	CODE B	26 See NOTE
CAN	18	2	32	L	4C	FNC 1	21 See NOTE
EM	19	3	33	M	4D	START A	(N/A)
						STOP	(N/A)

**NOTE:** Access for the alternate set of control function characters is by using SO (Shift Out, hex 0E). The SO control code identifies the next character as the control function character, and must be inserted before each alternate character required. The SO character is selectable from the printer's front panel.

Table 66 Code 128B Character Set

Character	Hex	Character	Hex	Character	Hex	Character	Hex
SP	20	:	3A	T	54	n	6E
!	21	;	3B	U	55	o	6F
"	22	<	3C	V	56	p	70
#	23	=	3D	W	57	q	71
\$	24	>	3E	X	58	r	72
%	25	?	3F	Y	59	s	73
&	26	@	40	Z	5A	t	74
'	27	A	41	[	5B	u	75
(	28	B	42	\	5C	v	76
)	29	C	43	]	5D	w	77
*	2A	D	44		5E	x	78
+	2B	E	45	-	5F	y	79
,	2C	F	46	`	60	z	7A
-	2D	G	47	a	61	{	7B
.	2E	H	48	b	62		7C
/	2F	I	49	c	63	}	7D
0	30	J	4A	d	64	~	7E
1	31	K	4B	e	65	■	7F
2	32	L	4C	f	66	FNC 3	23 See NOTE
3	33	M	4D	g	67	FNC 2	22 See NOTE
4	34	N	4E	h	68	SHIFT	28 See NOTE
5	35	O	4F	i	69	CODE C	27 See NOTE
6	36	P	50	j	6A	FUNC 4	24 See NOTE
7	37	Q	51	k	6B	CODE A	25 See NOTE
8	38	R	52	l	6C	FNC 1	21 See NOTE
9	39	S	53	m	6D	START B	(N/A)
						STOP	(N/A)

**NOTE:** Access for the alternate set of control function characters is by using SO (Shift Out, hex 0E). The SO control code identifies the next character as the control function character, and must be inserted before each alternate character required. The SO character is selectable from the printer's front panel.

**Table 67 Code 128C Character Set**

Character	Hex	Character	Hex	Character	Hex	Character	Hex
00	30 30	27	32 37	54	35 34	81	38 31
01	30 31	28	32 38	55	35 35	82	38 32
02	30 32	29	32 39	56	35 36	83	38 33
03	30 33	30	33 30	57	35 37	84	38 34
04	30 34	31	33 31	58	35 38	85	38 35
05	30 35	32	33 32	59	35 39	86	38 36
06	30 36	33	33 33	60	36 30	87	38 37
07	30 37	34	33 34	61	36 31	88	38 38
08	30 38	35	33 35	62	36 32	89	38 39
09	30 39	36	33 36	63	36 33	90	39 30
10	31 30	37	33 37	64	36 34	91	39 31
11	31 31	38	33 38	65	36 35	92	39 32
12	31 32	39	33 39	66	36 36	93	39 33
13	31 33	40	34 30	67	36 37	94	39 34
14	31 34	41	34 31	68	36 38	95	39 35
15	31 35	42	34 32	69	36 39	96	39 36
16	31 36	43	34 33	70	37 30	97	39 37
17	31 37	44	34 34	71	37 31	98	39 38
18	31 38	45	34 35	72	37 32	99	39 39
19	31 39	46	34 36	73	37 33	CODE B	26 See NOTE
20	32 30	47	34 37	74	37 34	CODE A	25 See NOTE
21	32 31	48	34 38	75	37 35	FNC 1	21 See NOTE
22	32 32	49	34 39	76	37 36	START C	(N/A)
23	32 33	50	35 30	77	37 37	STOP	(N/A)
24	32 34	51	35 31	78	37 38		
25	32 35	52	35 32	79	37 39		
26	32 36	53	35 33	80	38 30		

**NOTE:** Access for the alternate set of control function characters is by using SO (Shift Out, hex 0E). The SO control code identifies the next character as the control function character, and must be inserted before each alternate character required. The SO character is selectable from the printer's front panel.

## EAN 8

The EAN 8 barcode structure is shown in Figure 12 and described below.

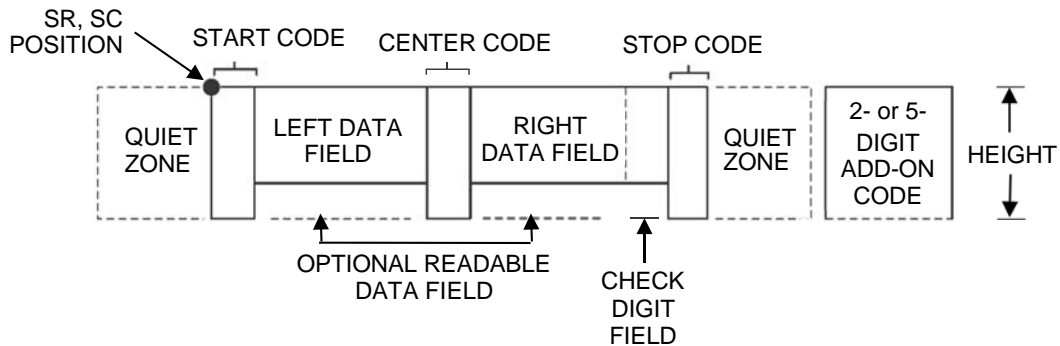

**Figure 12 EAN 8 Structure**

### Quiet Zone

Both ends of the barcode structure have blank quiet zones. The quiet zones must be at least 0.25 inches wide and completely blank to ensure accurate reading of the start/stop codes and to prevent adjacent barcodes from overlapping. You must provide sufficient space on the form for the quiet zones.

### Start/Center/Stop Codes

The start/center/stop codes are special character codes marking those portions of the barcode. These codes are automatically provided.

### Data Field

The barcode symbol uses a series of varying width bars and spaces to represent a limited character set (numbers 0-9 and Special Characters Start, Center, and Stop). The bars and spaces vary in width from one to four modules. Each character consists of two bars and two spaces that total seven modules. The symbol coding of the left data field is different from the right data field to permit read direction sensing.

### Readable Data

The human readable data field provides a readable interpretation of the barcode data. It can either be suppressed or printed above or below the barcode symbol.

### Check Digit

The modulo-10 check digit is automatically calculated and inserted in the barcode symbol. The check digit verifies accurate scanning.

## EAN 13

The EAN 13 barcode structure is shown in Figure 13 and described below.

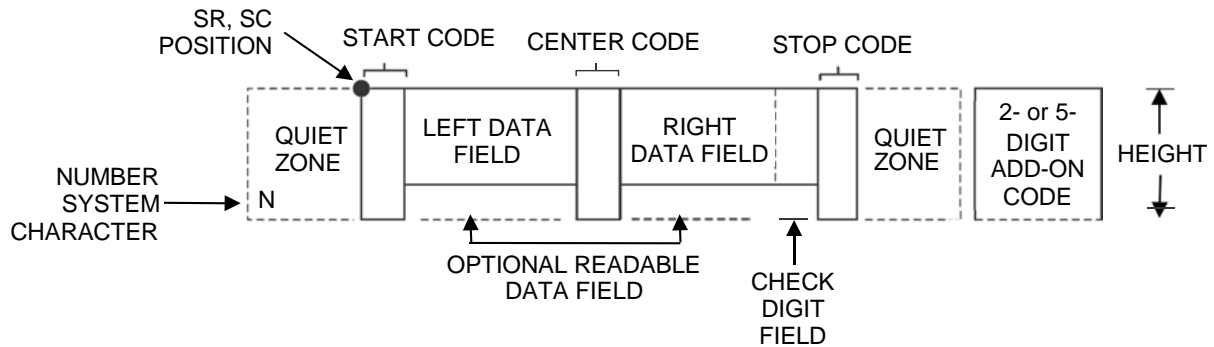

**Figure 13 EAN 13 Structure**

### Quiet Zone

Quiet zones extend on both ends of the barcode to permit the scan to begin and end in a blank area. You are responsible for providing sufficient space (minimum of seven modules) on the form for the quiet zones. The number system character is also printed automatically in the left quiet zone.

### Start/Center/Stop Codes

The start/center/stop codes are special character codes marking those portions of the barcode. These codes are automatically provided.

### Number System Character

The number system character field allows you to provide a code to a class or type of item. The first character in the data field is used as the number system character.

### Data Field

The barcode symbol uses a series of varying width bars and spaces to represent a limited character set (numbers 0-9 and Special Characters Start, Center, and Stop). The bars and spaces vary in width from one to four modules. The symbol coding of the left data field is different from the right data field to permit read direction sensing.

### Readable Data

The human readable data field provides a readable interpretation of the barcode data. It can be either suppressed or printed above or below the barcode symbol.

### Check Digit

The modulo-10 check digit is automatically calculated and inserted in the barcode symbol. The check digit verifies accurate scanning. The number system character is included in the check digit algorithm.



## FIM

The FIM (Facing Identification Mark) barcode structure is shown below and described on the following pages. The left boundary must begin 3 inches from the right edge of the mail piece. The right-most bar must be 2 inches + 1/8-inch from the right edge of the mail piece. Bars are 5/8-inch + 1/8-inch tall; the top of the bars must be no lower than 1/8-inch from the top edge of the mail piece (and may touch the top edge of the mail piece). The barcode baseline must be within 1/8-inch from the bottom edge of the quiet zone.

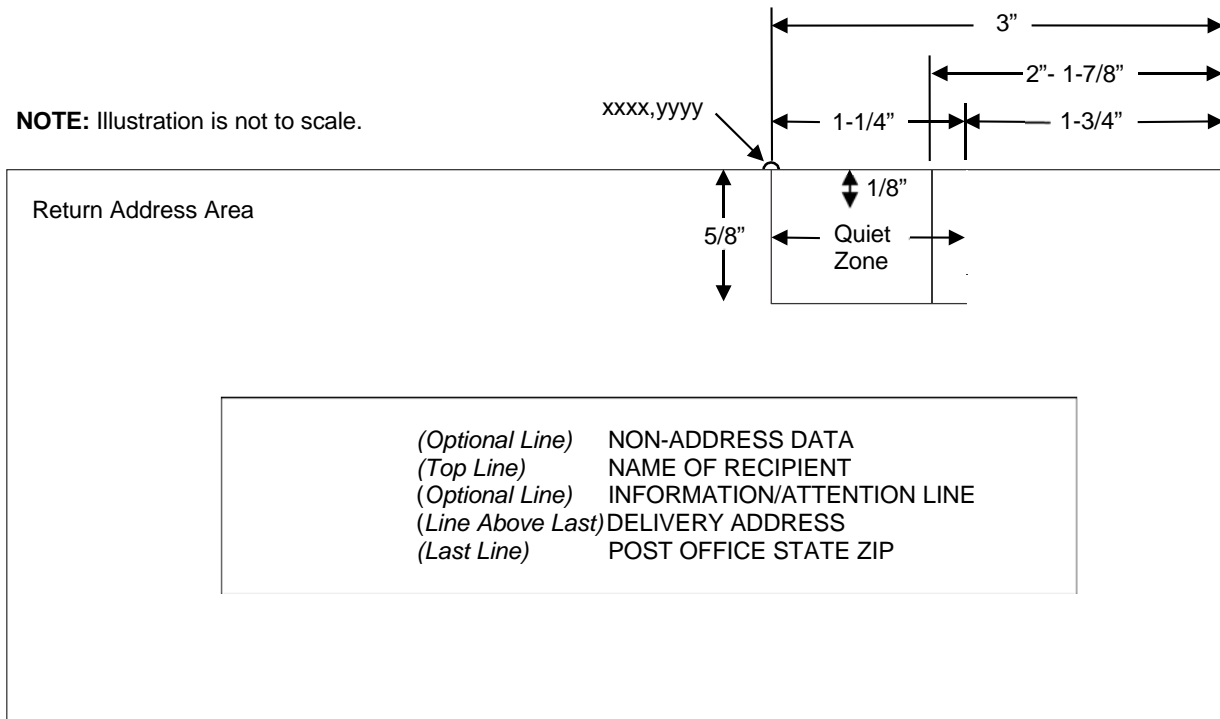

**Figure 14 FIM Structure**

**NOTE:** Additional information regarding FIM barcode requirements can be obtained from the U.S. Postal Service's Publication 25: *A Guide to Business Mail Preparation*.

### Quiet Zone

The barcode structure requires a completely blank, 1-1/4-inch wide, 5/8-inch tall quiet zone, reserved for only the appropriate FIM pattern. You must provide sufficient space for this zone.

### Start/Stop Code

The start/stop code is a unique character identifying the leading and trailing end of the barcode. The start/stop code is automatically produced with each barcode. The start/stop code structure permits bidirectional barcode scanning.

### Data Field

The barcode symbol uses a nine-position bar/no-bar pattern of tall (full) bars of uniform height. Use the letters "A," "B," "C," or "D" to specify the type of FIM.

Figure 15 illustrates how to generate a horizontal FIMC barcode and a POSTNET barcode.

```
ESC | } ; cF ; xCx ; N0 ; 0065 ; 0001 ; H01 <LF>
```

```
ESC | } ; cP ; x481701892x ; N0 ; 0050 ; 0020 ; H09
```

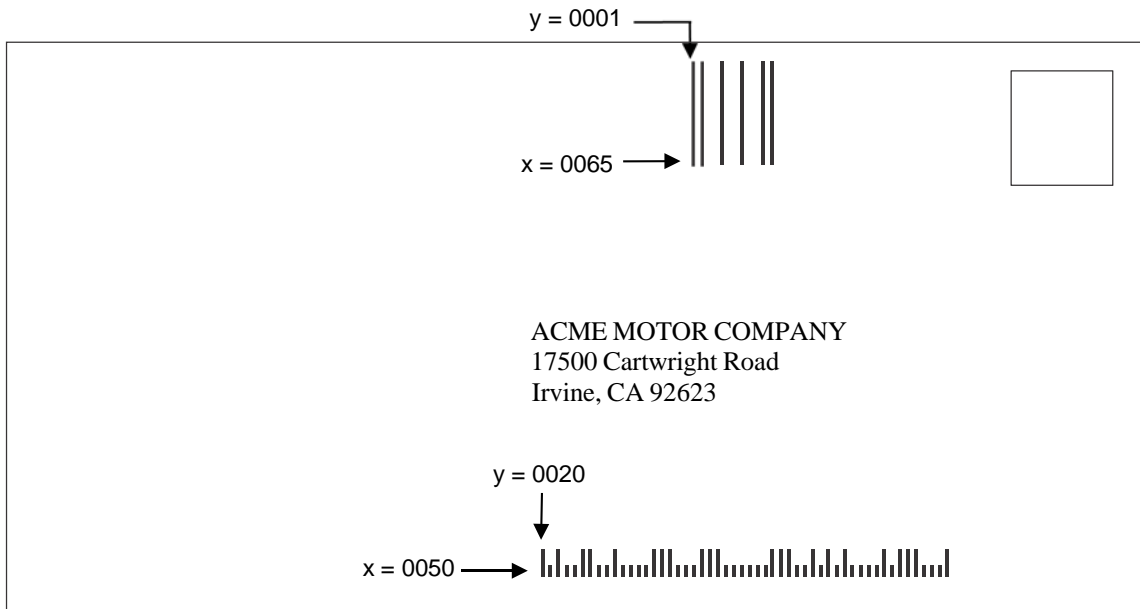

**NOTE:** Illustration is not to scale.

**Figure 15 Sample FIMC Barcode**

## Intelligent Mail 4-State Barcode

Intelligent Mail 4-state is a barcode symbology, introduced by USPS to support the US Mail 4-state customer barcode. It is also known as the USPS OneCode Solution or USPS 4-State Customer Barcode. This barcode is identified by four different types of bars:

- **Full Height** - fixed height
- **Tracker** - a small center section
- **Ascender** - extends from the top of the Full Height limit to the bottom of the Tracker limit.
- **Descender** - extends from the top of the Tracker Limit to the bottom of the Full Height limit.

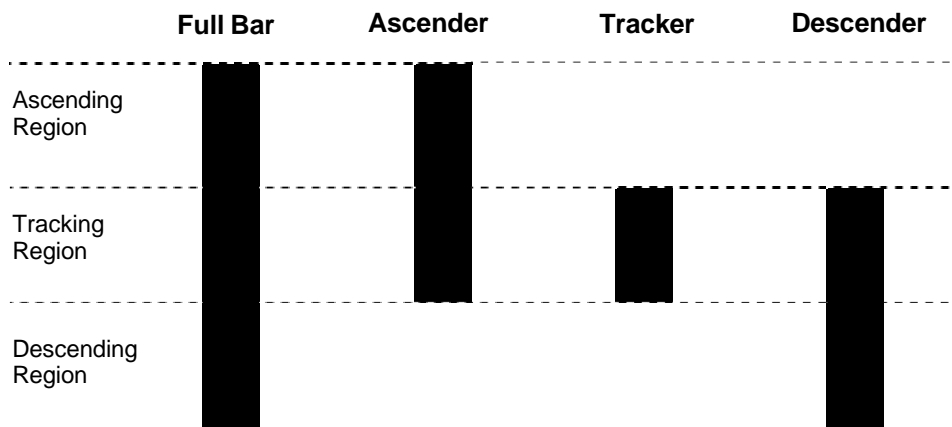

Figure 16 Intelligent Mail Barcode Bar Types

Customer Data must be in numeric format only. PDF is not allowed for Intelligent Mail Barcode.

Additional information regarding use of this barcode can be obtained from the USPS publication *Intelligent Mail Barcode Technical Resource Guide*.

Table 68 Data Field Parameters

Type	Field	Digits
Tracking Code	Barcode Identifier	2 Second digit must be 0 - 4.
	Service Type Identifier	3
	Mailer Identifier	6 or 9
	Serial Number	9 when Mailer ID is 6 digits 6 when Mailer ID is 9 digits
Routing Code	Delivery Point Zip Code	0, 5, 9, 11
Total		20 minimum, 31 maximum

## Interleaved 2/5 (I-2/5) and German I-2/5

The Interleaved 2/5 and German I-2/5 barcode structure is shown in Figure 17 and described below.

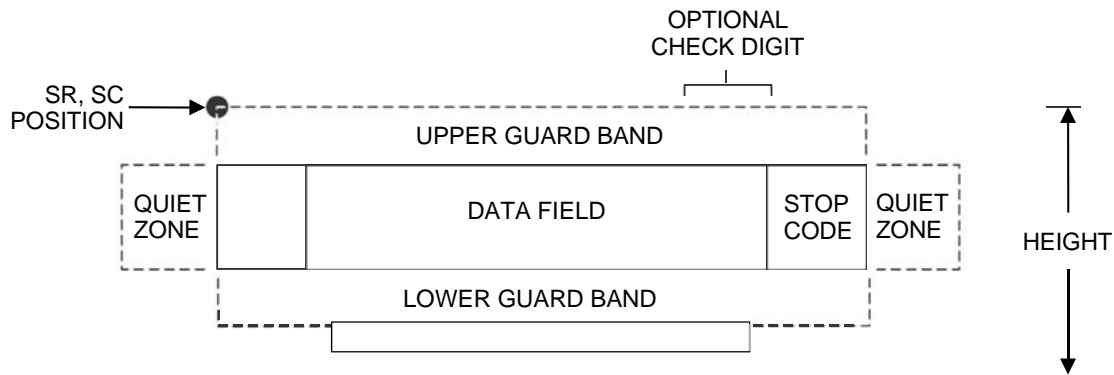

**Figure 17 I-2/5 Structure**

### Quiet Zone

Both ends of the barcode structure have blank quiet zones. The quiet zones must be at least 0.25 inches wide and completely blank to ensure accurate reading of the start/stop codes and to prevent adjacent barcodes from overlapping. You must provide sufficient space on the form for quiet zones.

### Start/Stop Codes

Unique start and stop codes permit bidirectional scanning. Both start and stop codes contain bars and spaces. They are automatically produced.

### Data Field

The barcode symbol uses a series of wide and narrow bars and spaces to represent numeric characters. The structure is 2 wide elements (bars or spaces) and 3 narrow elements. In the barcode, two characters are interleaved (paired); bars are used to represent the first character in the pair and spaces are used to represent the second character in the pair. While I-2/5 has a variable data field, German I-2/5 is restricted to 11 or 13 digits.

### Readable Data

The optional readable data field provides a readable interpretation of the barcode data. It can be printed above or below the barcode symbol.

### Check Digit

The modulo-10 check digit can be inserted into the barcode to verify accurate scanning. German I-2/5 bar codes have the check digit inserted automatically.

## MSI

The MSI bar code structure is shown in Figure 18 and described below.

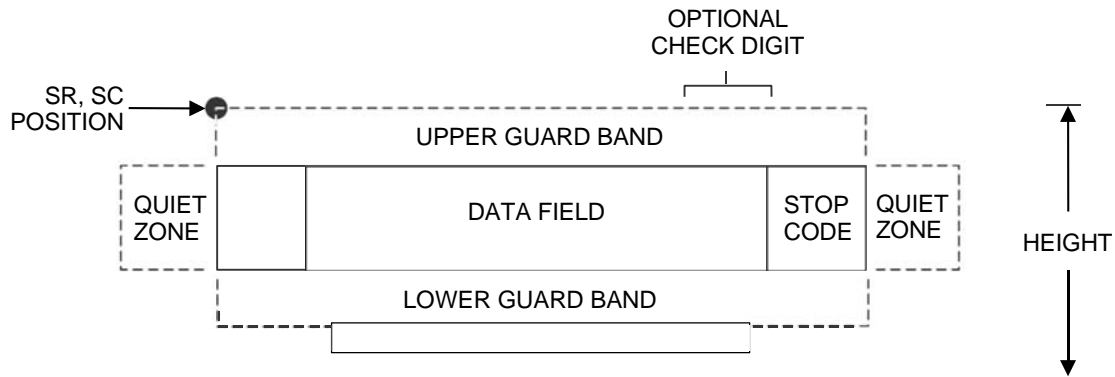

**Figure 18 MSI Structure**

### Quiet Zone

Both ends of the bar code structure require blank quiet zones. The quiet zones must be at least 0.25" wide and completely blank to ensure accurate reading of the start/stop codes and to prevent adjacent bar codes from overlapping. You must provide sufficient space on the form for quiet zones.

### Start/Stop Code

Unique start and stop codes permit bidirectional scanning. Both start and stop codes contain bars and spaces. They are automatically produced.

### Data Field

The bar code symbol uses a series of wide and narrow bars and spaces to represent each numeric character. The structure is four wide elements (bars or spaces) and four narrow elements. Each character contains four data bits, with each 0-bit made up of a narrow bar/wide space arrangement and each 1-bit made up of a wide bar/narrow space arrangement.

### Readable Data

The optional readable data field provides a readable interpretation of the bar code data. It can be printed above or below the bar code symbol.

### Check Digit

If specified, the modulo-10 or modulo-11 (or both) check digit is automatically calculated and inserted in the bar code symbol. The check digit verifies accurate scanning.

## PDF 417

The PDF417 structure is shown in Figure 19 and described below.

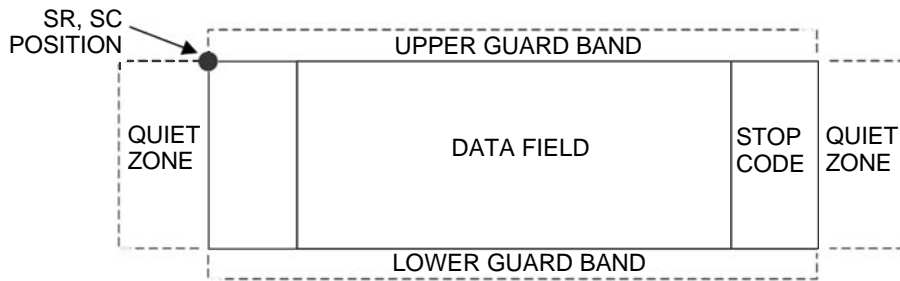

**Figure 19 PDF417 Structure**

### Quiet Zone

Both ends of the bar code structure require blank quiet zones. The quiet zones must be at least 0.25 inches wide and completely blank to ensure accurate reading of the start/stop codes and to prevent adjacent bar codes from overlapping. Be sure to provide sufficient space on the form for the quiet zones.

### Start/Stop Codes

The start/stop codes identify the leading and trailing end of the bar code.

### Data Field

PDF417 provides twelve modes to encode data. The first three are pre-established (the remaining nine are user modes, which can be defined by users or industry associations according to specific applications):

1. Extended Alphanumeric Compaction mode (EXC). Comprised of four sub-modes, this mode offers encodation of all printable ASCII characters. This is the default mode; LP+ uses shift or latch characters to enable other modes.
2. Binary/ASCII Plus mode. This offers encodation for all ASCII characters, printable or not, and binary values.
3. Numeric Compaction mode. This offers encodation for numeric values to a density of almost 3 digits per code word.

LP+ will automatically switch between modes to provide the smallest encodation for the data.

### Security Level

PDF417 can detect and correct errors. Each label has 2 code words of error detection. You can select the error correction capacity based on application needs. Specify a security level in the range of 0 - 8, at the time of printing. PDF417 can also recover from omissions and misdecodes of code words. Since it requires two code words to recover from a misdecode, one to detect the error and one to correct for it, a given security level can support half the number of misdecodes that it can of undecoded words.

### PDF

Print Data Field is not offered due to the large amount of data that can be encoded.

## PostBar and Royal Mail

The PostBar and Royal Mail barcode structure is shown in Figure 20 and described below

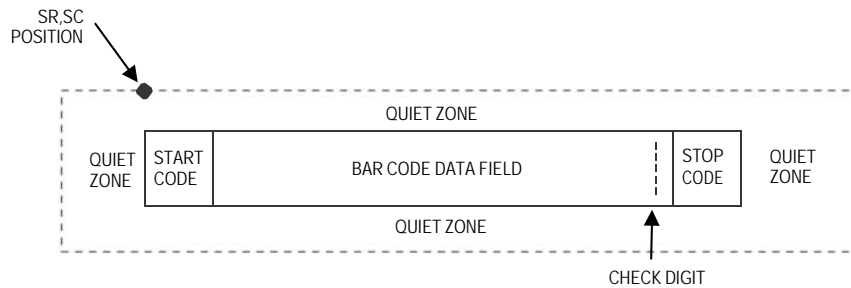

**Figure 20 PostBar and Royal Mail Structure**

PostBar and Royal Mail bar codes, like POSTNET, are used for mailing applications. However, these bar codes can encode full addresses on labels. These bar codes are similar to POSTNET in terms of bar space and width, but have four different types of bars (Full Height, Ascender, Descender, and Tracker), whereas POSTNET only has two bar types (Tall and Short).

The Royal Mail symbology converts alphanumeric characters into patterns of four bars, using combinations Full Height, Ascender, Descender, and Trackers. It also adds start and stop bar codes as well as a check digit.

PostBar allows you complete flexibility to specify the individual bar types that comprise the signal. For PostBar, you are responsible for encoding the address, adding the start and stop codes, and supplying the appropriate check digit.

### Quiet Zone

The bar code structure requires a completely blank quiet zone which is a 2mm border on each side of the bar code.

### Start/Stop Code

The start and stop bars identify the orientation of the bar code.

### Data Field

For PostBar, a variable length data field of digits `0' through `3' are allowed to represent the bars: Full Height (0), Ascender (1), Descender (2), and Tracker (3). For Royal Mail, the data is restricted to alphanumeric characters `A' through `Z' and `0' through `9'.

Each bar width is equal, and must be .020-inch  $\pm$  .005-inch. Horizontal spacing between bars (pitch) must be 22 bars  $\pm$  2 bars per inch over any 0.50-inch portion of the bar code. The height of the bars (Full Height) has a maximum of 0.230 inches and a minimum of 0.165 inches,

### Check Digit

For PostBar, you are responsible for encoding and check digit. For Royal Mail, a modulo-6 check digit is inserted at the end of the data field.

## POSTNET

The POSTNET barcode structure is illustrated in Figure 21 and described on the following pages. The POSTNET code can be a part of the address block and appear anywhere within a vertical 4-inch area across the length of the mail piece.

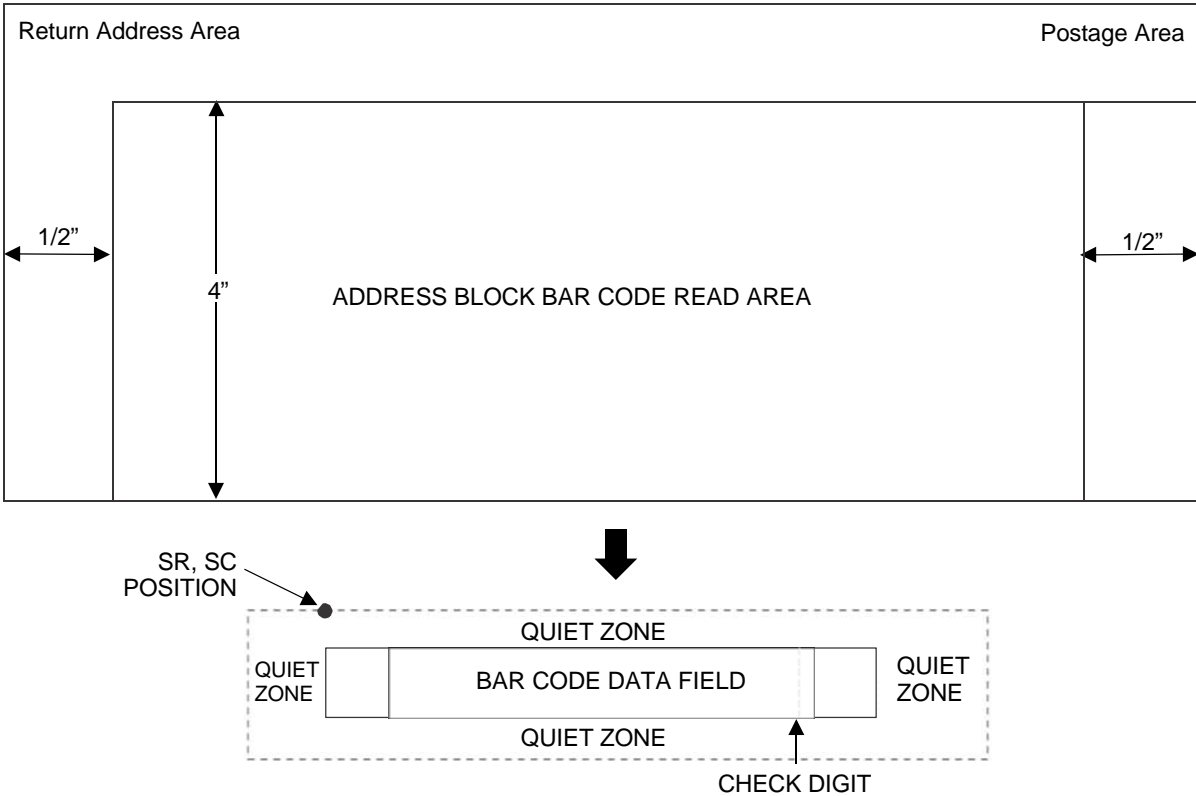

**Figure 21 POSTNET Structure**

**NOTE:** Additional information regarding POSTNET barcode requirements can be obtained from the U.S. Postal Service's Publication 25: *A Guide to Business Mail Preparation*.

### Quiet Zone

The barcode structure requires a completely blank quiet zone which extends 4.75 inches from the right edge of the mail piece. In addition, a minimum quiet zone of 0.040-inch above and below the barcode data must also be provided. You must provide sufficient space for this zone.

### Start/Stop Code

The start and stop codes are referred to as "framing bars" in POSTNET. The start and stop codes are each one tall bar, one identifying the leading and trailing end of the barcode. The start/stop code is automatically produced with each barcode. The start/stop code structure permits barcode scanning in a left-to-right direction only.



**Data Field**

The barcode data produces a single field of 30 bars for a 5-digit field, 50 bars for a 9-digit data field, or 60 bars for an 11-digit data field. The bars are grouped in sets of five. Each set of five bars (comprised of two tall bars and three short bars) represents one of the five digits of the zip code, plus the four-digit zip code extension. If the Advanced Barcode is used, an additional two-digit code is also added to make an 11-digit data field.

**Check Digit**

The sixth, tenth or twelfth digit represents the automatic check digit character for the 5, 9 or 11-digit data field, respectively. The check digit is added automatically to verify accurate scanning.

## Telepen

The Telepen structure is shown in Figure 22 and described below.

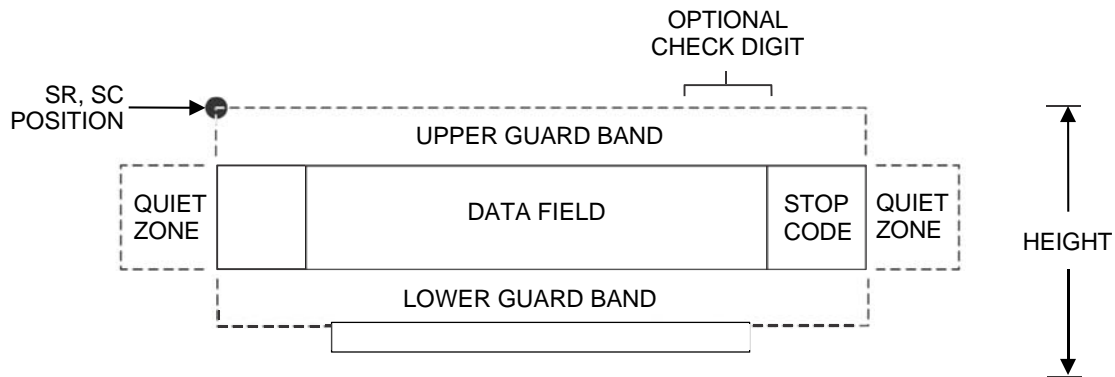

**Figure 22 Telepen Structure**

### Quiet Zone

Both ends of the bar code structure require blank quiet zones. The quiet zones must be at least 0.25" wide and completely blank to ensure accurate reading of the start/stop codes and to prevent adjacent bar codes from overlapping. Be sure to provide sufficient space on the form for quiet zones.

### Start/Stop Codes

The start/stop code is a unique character identifying the leading and trailing end of the bar code. The start/stop code is automatically produced with each bar code. The start/stop code structure permits bidirectional bar code scanning.

### Data Field

The bar code symbol uses a series of varying width bars and spaces to represent the entire ASCII character set. Each narrow bar or space is one element; each wide bar or space is three elements; each character in the data field has a total of sixteen elements.

### Readable Data

The optional readable data field provides a readable interpretation of the bar code data. It can be printed above or below the bar code symbol.

### Check Digit

The optional modulo-127 check digit can be inserted into the bar code to verify accurate scanning.

## UCC/EAN-128

The UCC/EAN-128 bar code structure is shown in Figure 23 and described below.

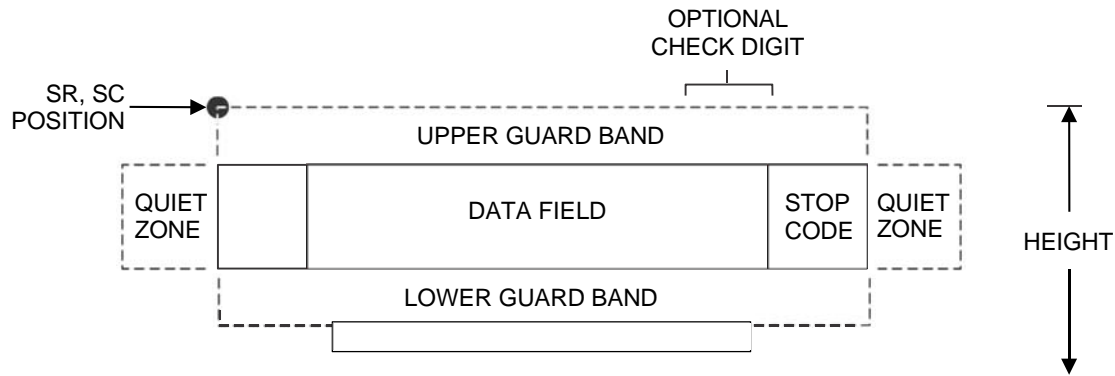

**Figure 23 UCC/EAN-128 Structure**

UCC/EAN-128 uses the same bar code and character set as Code 128. However, in UCC/EAN-128, the Function 1 character FNC1 immediately follows the start code. The FNC1 character has been reserved exclusively for UCC/EAN-128.

The UCC/EAN-128 data structure requires an Application Identifier (AI) at the beginning of bar code data. Each AI determines the format and length of the data which follows. Refer to Table 69 for more detail.

**Table 69 UCC/EAN-128 Application Identifiers**

Application Identifier (AI)	Content	Format
00	Serial Shipping Container Code	n2+n18
01	Shipping Container Code	n2+n14
02	Item Num. of Goods Within Another Unit	n2+n14
10	Batch or Lot Number	n2+an..20
11 (*)	Production Date (YYMMDD)	n2+n6
13 (*)	Packaging Date (YYMMDD)	n2+n6
15 (*)	Sell By Date (Quality) (YYMMDD)	n2+n6
17 (*)	Expiration Date (Safety) (YYMMDD)	n2+n6
20	Product Variant	n2+n2
21	Serial Number	n2+an..20
22	HIBCC = Quantity, Date, Batch and Link	n2+an..29
23 (**)	Lot Number (Transitional Use)	n3+n..19
240	Additional Product ID Assigned By Manufacturer	n3+an..30
250	Secondary Serial Number	n3+an..30
30	Quantity	n2+n..8
310 (***)	Net Weight, Kilograms	n4+n6
311 (***)	Length or 1st Dimension, Meters	n4+n6
312 (***)	Width, Diameter or 2nd Dimension, Meters	n4+n6
313 (***)	Depth, Thickness, Height or 3rd Dimension, Meters	n4+n6
314 (***)	Area, Square Meters	n4+n6
315 (***)	Volume, Liters	n4+n6
316 (***)	Volume, Cubic Meters	n4+n6

**Table 69 UCC/EAN-128 Application Identifiers**

<b>Application Identifier (AI)</b>	<b>Content</b>	<b>Format</b>
320 (***)	Net Weight, Pounds	n4+n6
321 (***)	Length Or 1st Dimension, Inches	n4+n6
322 (***)	Length Or 1st Dimension, Feet	n4+n6
323 (***)	Length Or 1st Dimension, Yards	n4+n6
324 (***)	Width, Diameter, or 2nd Dimension, Inches	n4+n6
325 (***)	Width, Diameter, or 2nd Dimension, Feet	n4+n6
326 (***)	Width, Diameter, or 2nd Dimension, Yards	n4+n6
327 (***)	Depth, Thickness, Height, or 3rd Dimension, Inches	n4+n6
328 (***)	Depth, Thickness, Height, or 3rd Dimension, Feet	n4+n6
329 (***)	Depth, Thickness, Height, or 3rd Dimension, Yards	n4+n6
330 (***)	Gross Weight-Kilograms	n4+n6
331 (***)	Length or 1st Dimension, Logistics	n4+n6
332 (***)	Width, Diameter, or 2nd Dimension, Meters, Logistics	n4+n6
333 (***)	Depth, Thickness, Height or 3rd Dimension, Meters, Logistics	n4+n6
334 (***)	Area, Square Meters, Logistics	n4+n6
335 (***)	Gross Volume, Liters	n4+n6
336 (***)	Gross Volume, Cubic Meters	n4+n6
337 (***)	Kilograms Per Square MEter	n4+n6
340 (***)	Gross Weight, Pounds	n4+n6
341 (***)	Length Or 1st Dimension, Inches, Logistics	n4+n6
342 (***)	Length Or 1st Dimension, Feet, Logistics	n4+n6
343 (***)	Length Or 1st Dimension, Yards, Logistics	n4+n6
344 (***)	Width, Diameter, or 2nd Dimension, Inches, Logistics	n4+n6
345 (***)	Width, Diameter, or 2nd Dimension, Feet, Logistics	n4+n6
346 (***)	Width, Diameter, or 2nd Dimension, Yards, Logistics	n4+n6
347 (***)	Depth, Thickness, Height or 3rd Dimension, Inches, Logistics	n4+n6
348 (***)	Depth, Thickness, Height or 3rd Dimension, Feet, Logistics	n4+n6
349 (***)	Depth, Thickness, Height or 3rd Dimension, Yards, Logistics	n4+n6
350 (***)	Area, Square Inches	n4+n6
351 (***)	Area, Square Feet	n4+n6
352 (***)	Area, Square Yards	n4+n6
353 (***)	Area, Square Inches, Logistics	n4+n6
354 (***)	Area, Square Feet, Logistics	n4+n6
355 (***)	Area, Square Yards, Logistics	n4+n6
356 (***)	Net Weight, Troy Ounce	n4+n6
357 (***)	Net Volume, Ounces	n4+n6
360 (***)	Volume, Quarts	n4+n6
361 (***)	Volume, Gallons	n4+n6
362 (***)	Gross Volume, Quarts	n4+n6
363 (***)	Gross Volume, Gallons	n4+n6
364 (***)	Volume, Cubic Inches	n4+n6
365 (***)	Volume, Cubic Feet	n4+n6
366 (***)	Volume, Cubic Yards	n4+n6
367 (***)	Gross Volume, Cubic Inches	n4+n6

**Table 69 UCC/EAN-128 Application Identifiers**

<b>Application Identifier (AI)</b>	<b>Content</b>	<b>Format</b>
368 (**)	Gross Volume, Cubic Inches	n4+n6
369 (**)	Gross Volume, Cubic Inches	n4+n6
37	Quantity of Units Contained (For Use With AI 02 Only)	n2+n..8
400	Customer's Purchase Order Number	n3+an..30
401	Consignment Number	n3+an..30
410	Ship To (Deliver To) Location Code Using EAN-13	n3+n13
411	Bill To (Invoice To) Location Code Using EAN-13	n3+n13
412	Purchase From (Location Code of Party From Whom Goods Are Purchased)	n3+n13
413	Ship For UCC/EAN Location Code	n3+n13
414	EAN Location Code For Physical Identification	n3+n13
420	Ship To (Deliver To) Postal Code Within a Single Postal Authority	n3+an..20
421	Ship To (Deliver To) Postal Code With 3-Digit ISO Country Code Prefix	n3+n3+an..9
8001	Roll Products-Width, Length, Core Diameter, Direction and Splices	n4+n14
8003	UPC/EAN Number and Serial Number Or Returnable Asset	n4+n14+an..16
8004	UCC/EAN Serial Identification	n4+an..30
8005	Identifies the Price Per Unit of Measure	n4+n6
8006	Component of an Article	n4+n14+n2+n2
8018	Service Relation Number	n4+n18
8100	Coupon Extended Code-Number System Character and Offer	n4+n1+n5
8101	Coupon Extended Code-Number System Character, Offer and End of Offer	n4+n1+n5+n4
8102	Coupon Extended Code-Number System Character Preceded by Zero	n4+n1+n1
90	Mutually Agreed, Between Trading Partners	n2+an..30
91	Intra-Company (Internal)	n2+an..30
92	Intra-Company (Internal)	n2+an..30
93	Intra-Company (Internal)	n2+an..30
94	Intra-Company (Internal)	n2+an..30
95	Internal-Carriers	n2+an..30
96	Internal-Carriers	n2+an..30
97	Intra-Company (Internal)	n2+an..30
98	Intra-Company (Internal)	n2+an..30
99	Internal	n2+an..30

(\*) To indicate only year and month, DD must be filled with "00"

(\*\*) Plus one digit for length indication

(\*\*\*) Plus one digit for decimal point indication

Data Value Representation:

a	alphabetic characters	n	numeric characters
an	alpha-numeric characters	n3	3 numeric characters, fixed length
an..3	up to 3 alpha-numeric characters	n..3	up to 3 numeric characters

**Quiet Zone**

Both ends of the bar code structure require blank quiet zones. The quiet zones must be at least 0.25 inches wide and completely blank to ensure accurate reading of the start/stop codes and to prevent adjacent bar codes from overlapping. You must provide sufficient space on the form for the quiet zones.

## Start/Stop Codes

The start and stop codes identify the leading and trailing ends of the bar code. UCC/EAN-128 uses unique start codes for character subsets B and C, and a stop code common to both. An automatic mode switching feature is used to generate the correct start code based on the first four data field characters.

## Data Field

UCC/EAN-128 bar codes require a special character called "Function 1" (FNC1) to immediately follow the start code. LP+ automatically supplies this character, so it must not be included in the data field by the user.

A character is made up of three bars and three spaces, each varying in width from 1 to 4 modules, for a total of eleven modules. The number of modules making up the bars is even. The stop code has four bars and is 13 modules wide.

The character set for UCC/EAN-128 is the same as the character set for Code 128. Refer to the Code 128 Character Sets (see page 188). Every character is interpreted according to the currently active character subset. UCC/EAN-128 uses subset B and subset C only. Subset B, shown in Table 66 (page 189), includes all standard alphanumeric keyboard characters, lowercase alphabetical characters, and special characters. Subset C interprets the characters as pairs of numbers 00 through 99, along with some special characters, as shown in Table 67 (page 190). The start code or subset switch code determines whether a particular bar code character is decoded as one character or as a pair of numbers.

## Readable Data

The optional printed data field (PDF) provides a human-readable interpretation of the bar code data. When the printed data field is enabled by use of the "PDF" parameter, the overall height of the bars is reduced to make room for a guard band and the human-readable characters. The printed data field will be formatted with spaces or parentheses denoting particular data fields such as the application identifier. Special characters such as start, stop, subset switch, modulo-103 check digit, and FNC1 do not appear in the human-readable data.

The readable data is oriented along the bar code from start code to stop code. It may be positioned above or below a bar code.

## Modulo-103 Check Digit

A modulo-103 check digit is automatically calculated and inserted in the bar code symbol immediately in front of the stop code, in the same manner as the Code 128 bar code. The check digit verifies accurate scanning. The start code is included in the check digit algorithm. The modulo-103 check digit is not displayed in the readable data field.

## Modulo-10 Data Field Check Digit for SSCC-18 and SCC-14

AI 00 (called the Serial Shipping Container Code, or SSCC-18) takes eighteen additional numerical data bytes. The last data byte is a modulo-10 check digit on the preceding seventeen data bytes. Counting the two zeros of the application identifier, the modulo-10 check digit is the twentieth byte in the data field.

AI 01 (called the Shipping Container Code, or SCC-14) takes fourteen additional numerical data bytes. The last data byte is a modulo-10 check digit on the preceding thirteen data bytes. Counting the zero and the one of the application identifier, the modulo-10 check digit is the sixteenth byte in the data field.

The modulo-10 data field check digit for both SSCC-18 and SCC-14 is printed in the bar code as the second half of the last number pair using subset C. It is displayed in the human-readable data field as the twentieth byte for SSCC-18 or the sixteenth byte for SCC-14.

LP+ automatically calculates the modulo-10 check digit for SSCC-18 if only 17 data digits are provided following the application identifier of 00.

## UPC-A

The UPC-A barcode structure is shown in Figure 24 and described below.

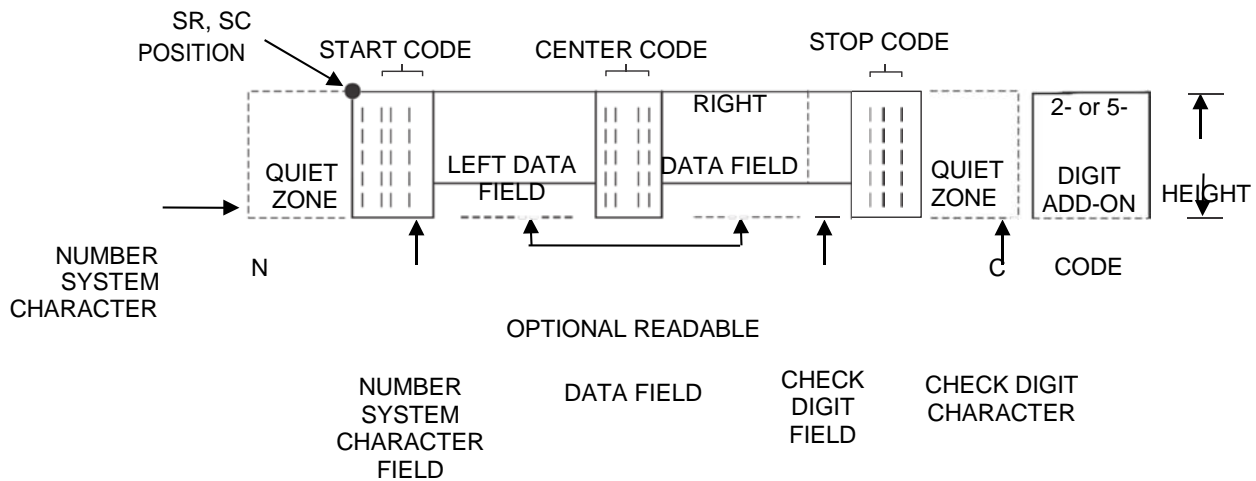

**Figure 24 UPC-A Structure**

### Quiet Zone

Quiet zones extend on both ends of the barcode to permit the scan to begin and end in a blank area. The number system character is also printed automatically in the left quiet zone.

### Start/Center/Stop Codes

The start/center/stop codes are special character codes marking those portions of the barcode. These codes are automatically provided.

### Number System Character

The number system character field allows you to provide a code to a class or type of item. The first character in the data field is used as the number system character.

### Data Field

The barcode symbol uses a series of varying width bars and spaces to represent a limited character set (numbers 0-9 and Special Characters Start, Center, and Stop). The bars and spaces vary in width from one to four modules. Each character consists of two bars and two spaces that total seven modules. The symbol coding of the left data field is different from the right data field to permit read direction sensing.

### Readable Data

The human readable data field provides a readable interpretation of the barcode data. It can either be suppressed or printed above or below the barcode symbol.

### Check Digit

The modulo-10 check digit is automatically calculated and inserted in the barcode symbol. The check digit verifies accurate scanning. The number system character is included in the check digit algorithm.





## UPC-E

The UPC-E barcode structure is shown in Figure 25 and described below.

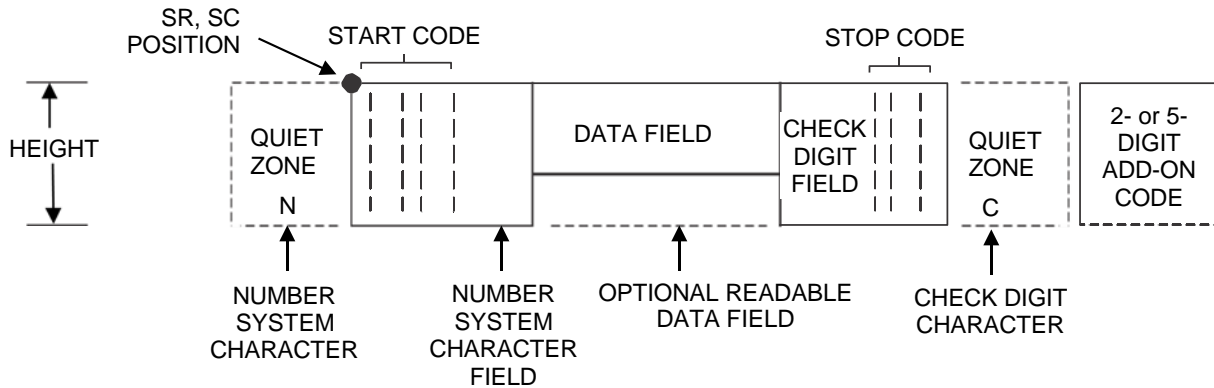

Figure 25 UPC-E Structure

### Quiet Zone

Quiet zones extend on both ends of the barcode to permit the scan to begin and end in a blank area. You must provide sufficient space (minimum of seven modules) on the form for the quiet zones. The number system character is also printed automatically in the left quiet zone.

### Start/Stop Codes

The start/stop codes are special character codes marking those portions of the barcode. These codes are automatically provided.

### Number System Character

The number system character field for all UPC-E barcodes must be zero.

### Data Field

The barcode symbol uses a series of varying width bars and spaces to represent a limited character set (numbers 0-9 and Special Characters Start and Stop). The bars and spaces vary in width from one to four modules. For UPC-E, eleven digits are expected, which are compressed down to the six encoded symbol characters.

### Readable Data

The human readable data field provides a readable interpretation of the barcode data. It can either be suppressed or printed above or below the barcode symbol.

### Check Digit

The modulo-10 check digit is automatically calculated and inserted in the barcode symbol. The check digit verifies accurate scanning. The number system character is included in the check digit algorithm.

**Table 70 Eleven-Digit Compression**

1. Manufacturer's Number					Product Numbers that can be used 00000-00999		
<u>X</u>	<u>X</u>	<u>0</u>	<u>0</u>	<u>0</u>	( <u>  </u> )	( <u>  </u> )	( <u> </u> )
<u>X</u>	<u>X</u>	<u>1</u>	<u>0</u>	<u>0</u>	first two digits of manufacturer's number	last three digits of the product number	third digit of the manufacturer's number, use 0 through 2 only
<u>X</u>	<u>X</u>	<u>2</u>	<u>0</u>	<u>0</u>			

2. Manufacturer's Number					Product Numbers that can be used 00000-00999		
<u>X</u>	<u>X</u>	<u>3</u>	<u>0</u>	<u>0</u>	( <u>  </u> )	( <u>  </u> )	( <u>3</u> )
<u>X</u>	<u>X</u>	<u>9</u>	<u>0</u>	<u>0</u>	first three digits of manufacturer's number	last two digits of the product number; use 00-99 only	depends on how many digits appear in the manufacturer's number

3. Manufacturer's Number					Product Numbers that can be used 00000-00999		
<u>X</u>	<u>X</u>	<u>X</u>	<u>X</u>	<u>0</u>	( <u>  </u> )	( <u> </u> )	( <u>4</u> )
					first four digits of manufacturer's number	last digit of product number, use 0 through 9 only	depends on how many digits appear in the manufacturer's number

4. Manufacturer's Number					Product Numbers that can be used 00000-00999	
<u>X</u>	<u>X</u>	<u>X</u>	<u>X</u>	<u>X</u>	( <u>  </u> )	( <u> </u> )
					all five digits of manufacturer's number	Last digit of product number, use 5-9 only

**Table 71 Six-Digit Zero Expansion**

<b>if the 6 digit number ends with:</b>	<b>then the MFPS number is:</b>	<b>and the Product Number is:</b>
0 Example: 124560	the first 2 digits (of the zero suppressed number) plus <u>00</u> 12000	00 plus the THIRD, FOURTH and FIFTH digit (of the zero suppressed number) 00456
1 Example: 275831	the first two digits plus <u>100</u> 27100	same as above 00583
2 Example: 412022	the first two digits plus <u>200</u> 41200	same as above 00202
3 Example: 876543	the first three digits plus <u>00</u> 87600	000 plus the FOURTH and FIFTH digit 00054
4 Example: 753774	the first four digits plus <u>0</u> 75370	0000 plus the FIFTH digit 00007
5, 6, 7, 8, 9 Examples: 213756 517019	the first five digits of the zero suppressed number 21375 51701	0000 plus the SIXTH digit  00006 00009

## UPC Shipping

The UPCSHIP bar code structure is shown in Figure 26 and described below.

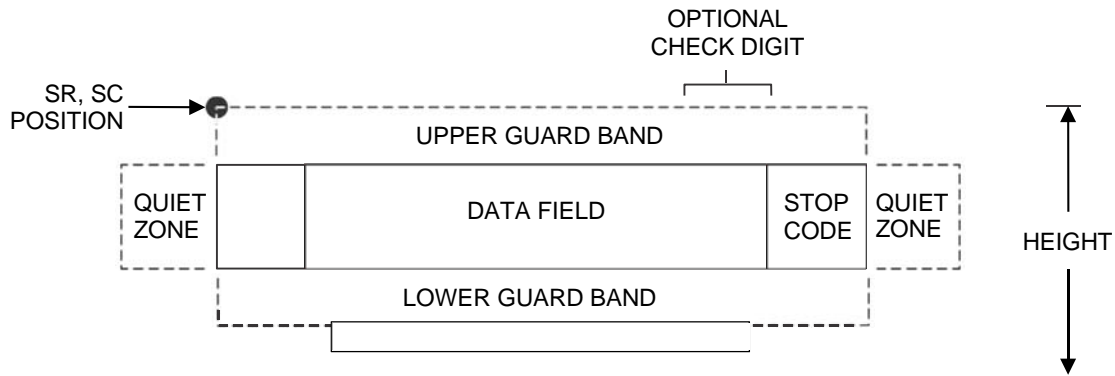

**Figure 26 UPCSHIP Structure**

### Quiet Zone

Both ends of the bar code structure have blank quiet zones. The quiet zones should be at least 0.25 inches wide and completely blank to ensure accurate reading of the start/stop codes and to prevent adjacent bar codes from overlapping. You are responsible for providing sufficient space on the form for the quiet zones.

### Start/Stop Codes

Unique start and stop codes permit bidirectional scanning. Both start and stop codes contain bars and spaces. They are automatically produced.

### Data Field

The bar code symbol uses a series of wide and narrow bars and spaces to represent numeric characters. The structure is 2 wide elements (bars or spaces) and 3 narrow elements.

### Readable Data

The optional readable data field provides a readable interpretation of the bar code data. Bar code data is printed below the horizontal bar code symbol. The lower guard band is provided when the readable data field is selected.

### Check Digit

The modulo-10 check digit is automatically calculated and inserted in the bar code symbol. The check digit provides the means to verify accurate scanning.

## UPS 11

The UPS 11 structure is shown in Figure 27 and described below.

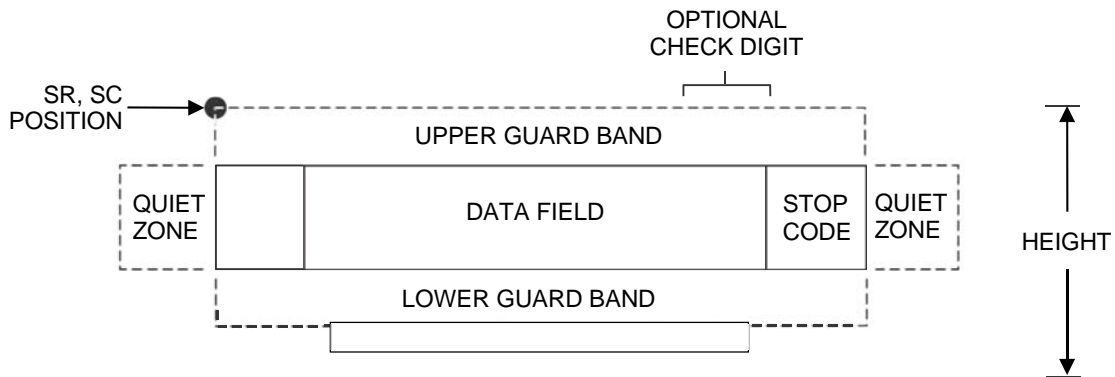

**Figure 27 UPS 11 Structure**

### Quiet Zone

Both ends of the bar code structure require blank quiet zones. The quiet zones must be at least 0.25 inches wide and completely blank to ensure accurate reading of the start/stop codes and to prevent adjacent bar codes from overlapping. Be sure to provide sufficient space on the form for the quiet zones.

### Start/Stop Codes

The start/stop codes identify the leading and trailing end of the bar code. Each of the UPS 11 subsets uses a unique start code and a common stop code, both automatically provided by the IGP/PGL.

### Data Field

UPS 11 is a special case of Code 128 (page 187). This bar code is restricted to 10 data characters. The first character must be 0 through 9 or A through Z. The remaining nine digits must be 0 through 9.

### Readable Data

The optional readable data field provides a readable interpretation of the bar code data. It can be printed above or below the bar code symbol.

### Check Digit

The modulo-103 check digit is automatically calculated and inserted in the bar code symbol. The check digit verifies accurate scanning. The start code is included in the check digit algorithm.



# 8 Graphics

## Overview

This chapter explains how the printer produces graphic images.

The quickest way to produce graphic images is to use one of the many graphics software applications available. Any graphics program that is compatible with the Epson FX, Proprinter III XL, P-Series, Serial Matrix, or P-Series XQ Variant emulation should provide excellent results.

You can also use the Intelligent Graphics Printing (IGP) emulation or the VGL emulation. Both allow you to create and store forms, generate logos, bar codes, expanded characters, and other graphics.

Printing text and characters is the default mode of operation. However, your printer can print graphics.

- When the emulation is in the Proprinter III XL, Epson, or Serial Matrix protocol mode, Bit Image graphics is used for graphics printing.
- When the emulation is in the P-Series or P-Series XQ Variant protocol mode, Odd/Even dot plotting is used for graphics printing.

Each line of graphics data must include a graphics control code to enable the emulation for the desired graphics mode of operation.

## Bit Image Graphics

When the printer uses the IBM Proprinter III XL, Epson, or Serial Matrix emulation, it creates graphics by accepting bit image graphics data.

**NOTE:** Text and graphics can be mixed on the same line when the printer plots bit images in the Epson or Proprinter III XL emulation.

Bit image graphics are created by vertically printing the bit pattern of a series of data bytes. For example, the bit pattern of the ASCII character A (hex 41, decimal 65) is shown in Figure 28. If we rotate this data byte 90 degrees clockwise, we have a vertical data byte with the most significant bit (MSB) at the top. If we then print each 1 (true) bit as a dot, the result is a “bit image” plot of the ASCII character A.

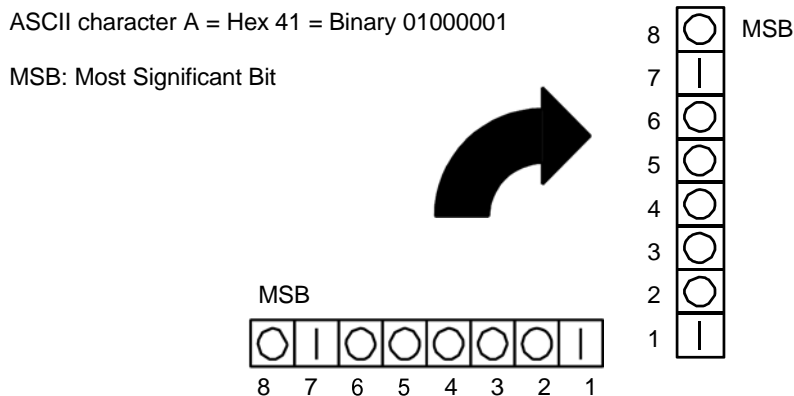

Figure 28 Vertical Data Byte Pattern

The relationship between the ASCII character, its decimal value, and its bit image plot is shown in Figure 29. All 8 bits of the data byte are used in all fonts, but some fonts have taller and shorter characters. You may have to adjust the line spacing in order to print without horizontal gaps. Data bytes are identified by their binary, octal, hexadecimal, or decimal equivalents. These numeric equivalents are combined in data streams to form graphic patterns such as the one illustrated in Figure 30.

ASCII CHARACTER	DECIMAL VALUE	BINARY CODE EQUIVALENT	TO	VERTICALLY ROTATED DATA BYTE	Printed Bit Image
A	= 65 =	128	MSB	○	=
		64			
		32		○	
		16		○	
		8		○	
		4		○	
		2		○	
		1			
					●
					●

**Figure 29 Bit Image Pattern from an ASCII Character**

Bit Image plotting is not limited to printable ASCII characters. You can print Bit Image patterns for any 8-bit data byte with decimal values ranging from 0 through 255. (The ASCII character set is charted in Appendix C.)

### Designing a Bit Image Pattern

A Bit Image pattern is produced in four steps:

1. On a quadrille pad or graph paper, lay out the graphic pattern you want to print. (See Figure 30.)
2. Determine the decimal equivalent of each vertical data byte in your pattern. (The sum of the decimal equivalent of each true bit in the vertical data byte is the decimal equivalent of the data byte.)
3. Write a program to generate the pattern.
4. Enter and run the program on the host computer.



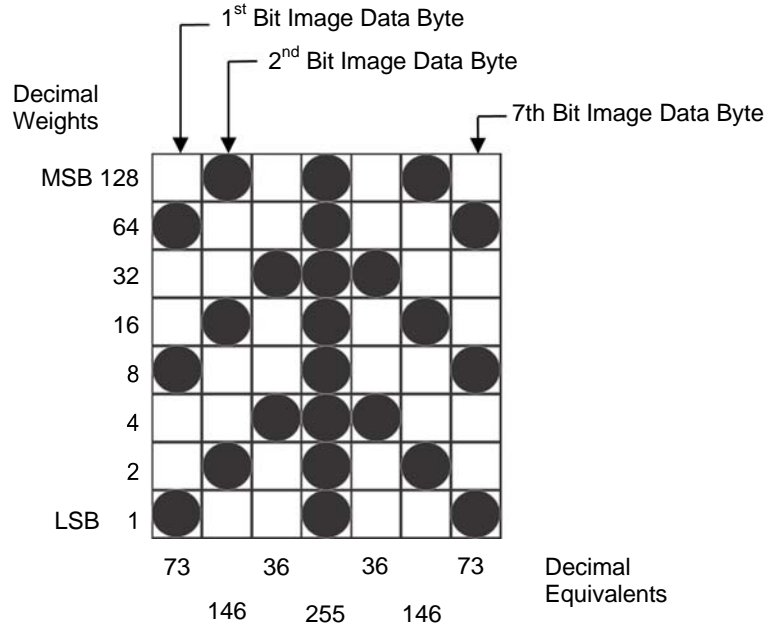

**Figure 30 Bit Image Pattern Plan**

## Bit Image Density

You can print bit image graphics in different dot densities. Select dot densities by sending a control code in the data stream:

**NOTE:** Every line of graphics data must include the necessary plot mode command so the printer can perform the chosen graphics functions.

### Single Density Mode: ESC K

Single density bit image graphics in a Data Processing (DP) print quality are printed at 60 dots per inch (dpi) horizontally and 72 dpi vertically. For NLQ print quality, the horizontal dot density is 90 dpi and vertical dot density is 96 dpi. For High Speed (HS) draft print quality, horizontal dot density is 60 dpi and vertical dot density is 48 dpi.

### Double Density Mode: ESC L

Double density mode prints up to twice the number of dots per inch horizontally in the same space used for single density. The vertical dot density remains the same as in single density mode. Double horizontal density requires twice the number of input data bytes to print the same length line as single density. Printing double density reduces the printing speed by half.

### Double Speed – Double Density Mode: ESC Y

When the double density – double speed control code is received, data bytes print at double the current horizontal dot density, but adjacent dots are not printed. Since double density graphics are printed at half speed, double speed – double density graphics are printed at the same speed as single density graphics. This mode is often used to position a simulated print head precisely by sending blank dot columns.

### Quadruple Density Mode: ESC Z

When printing quadruple density graphics, the printer combines adjacent quadruple density bit image bytes. The compounded data are then printed in double density mode.

## Bit Image Programming Format

The bit image command format is:

ESC CC *n1 n2 DATA*

**where:**

ESC            the serial matrix SFCC  
CC            K, L, Y or Z to select dot density  
              (K = single, L = double, Y = double density – double speed, Z=quadruple density)  
*n1*            (Number of DATA bytes) – 256(*n2*)  
              (remainder of division of number of DATA bytes by 256, sometimes referred to  
              as MOD 256)  
*n2*            (Number of DATA bytes)/256 (quotient of division)  
DATA          the dot pattern bytes

The syntax of the bit image expression must be correct.

The number of data bytes and the *n1*, *n2* definition must be equal.

Any characters following *n1* and *n2* are interpreted and plotted as data until the *n1*, *n2* definition is satisfied.

If *n1* = *n2* = 0, then control codes K, L, Y, or Z are ignored.

The maximum number of data bytes that can be included in the DATA portion of the program statement (when using 132 column paper) varies according to the dot density:

At 60 dpi, single density = 792 bytes

double density = 1584 bytes

quadruple density = 3168 bytes

Data that go past the right margin are discarded if automatic line feed is disabled. If automatic line feed is enabled, data that go past the right margin trigger an automatic line feed (LF) and are printed on the next line.

## Bit Image Sample Program

The program below, written in BASIC, produces the single density bit image pattern shown in Figure 31. The 7–byte pattern is repeated 40 times.

Depending on the host computer system, it may be necessary to add a width statement to the BASIC program.

```
10 WIDTH "lpt1:", 255
20 LPRINT "Single Density Bit Image Graphics"
30 LPRINT CHR$(27);"K";CHR$(24);CHR$(1);
40 FOR N=1 TO 40
50 RESTORE
60 FOR I=1 TO 7
70 READ R
80 LPRINT CHR$(R);
90 NEXT I
100 NEXT N
110 DATA 73, 146, 36, 255, 36, 146, 73
120 LPRINT
```

## Single Density Bit Image Graphics



Figure 31 Sample Single - Density Bit Image Graphics

## Plot Mode

Plot mode is available for the P-Series and P-Series XQ Variant protocols.

This subsection describes the P-Series compatible odd/even dot Plot mode of operation. The P-Series plot has a rigid format wherein each line of data contains a plot command code, the plot data, and an LF code (hex 0A).

The P-Series codes (hex 04 and 05, respectively) can be placed anywhere on the command line.

The P-Series XQ codes (hex 04 and 05, respectively) can also be placed anywhere on the command line without degrading plot speed.

When P-Series Plot mode is enabled by an EOT (hex 04) or ENQ (05) code, all control codes except LF, CR, and FF, are ignored. Any control sequence parameter prior to a plot code is acted upon immediately. Any control sequence parameter following an EOT or ENQ code is treated as plot data.

If any combination of EOT (hex 04) or ENQ (05) code is received in a single line, the priority of action is:

- EOT (hex 04) takes priority over ENQ (hex 05)
- ENQ has the same priority level and is acted upon in the order received

A printable symbol is defined as any character or command that might cause the head of a serial printer to move away from character column one.

## Plot Density

Plot density refers to the number of dots per inch (dpi) printed in a single dot row. Two types of plot density are available with P-Series Plot mode graphics: normal density and high density. The densities can be mixed within the printed page on a dot row-by-row basis, but the two densities cannot be mixed on the same dot row.

### Normal Density Plot Mode

Normal density plotting is selected with the odd dot plot control code ENQ (05 hex). The odd-numbered dot columns are addressed to produce a horizontal and vertical density that varies with the font selected:

- Data Processing (DP) = 60 dpi horizontal, 72 dpi vertical
- Near Letter Quality (NLQ) = 90 dpi horizontal, 96 dpi vertical
- High Speed Draft (HS) = 60 dpi horizontal, 48 dpi vertical

Figure 32 illustrates normal density dot plot.

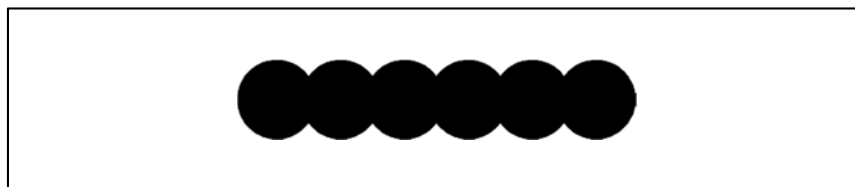

Figure 32 Normal Density Plot

### Double Density Plot Mode

High density plotting is selected with the even dot plot control code EOT (hex 04) in conjunction with the odd dot plot control code ENQ (hex 05). The odd and even numbered dot columns are addressed to double the horizontal density. The vertical density remains the same in normal and high density plotting, though vertical density is based on the current print mode.

Figure 33 illustrates high density plotting.



Figure 33 High Density Plot

### Plot Data Byte Format

In P-Series/P-Series XQ Variant Plot Mode, the format is as follows:

- Each data byte specifies six out of twelve plot dot columns.
- Using odd dot plot mode, bits 1 through 6 of the data byte address the odd-numbered dot columns; using even dot plot mode, bits 1 through 6 of the data byte address the even-numbered dot columns.
- Bit 6 and/or bit 7 of the data byte must be a “1” (or true) bit in Plot mode.
- Bit 8 of the data byte is not used in the Plot mode and may be 1 or 0.
- The binary equivalent of the plot data bytes must be known to accurately address specific dot positions.

As shown in Figure 34, a dot is printed at the location addressed by each of bits 1 through 6 in the data byte that is set (1 or true).

### EVEN DOT PLOT DATA BYTE

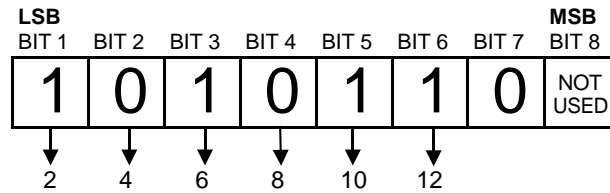

**NOTE:** BIT 6 AND/OR BIT 7 MUST BE "1" FOR PLOT MODE

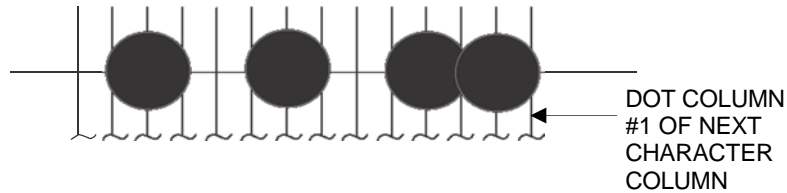

DOT COLUMN #12 OF PREVIOUS CHARACTER COLUMN →

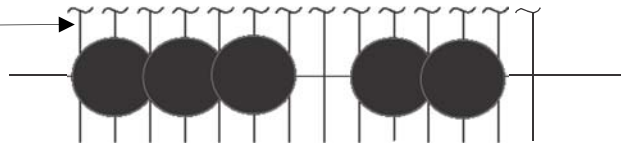

**NOTE:** IN ACTUAL PRINTING, THESE TWO ROWS MERGE TO PRINT ON THE SAME ROW.

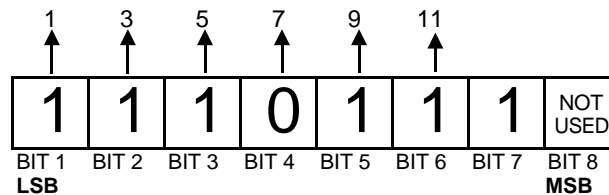

### ODD DOT PLOT DATA BYTE

**Figure 34 P-Series/P-Series XQ Variant Plot Data Byte Format**

### Plot Data Line Format

A P-Series plot data line contains the following: (See Figure 35.)

- The plot mode control code: either hex 05 for normal density, or hex 04 (even dot plot) combined with hex 05 (odd dot plot) for double density plotting.
- The data bytes to be plotted.
- The line terminator hex 0A or hex 0C.
- With print width set to 13.2 inches, a plot data line may contain any number of bytes up to a maximum of 132 for horizontal dot density of 60 dpi (DP font) or 198 bytes for a horizontal dot density of 90 dpi (NLQ font).
- A plot data line may contain any number of data bytes up to the maximum. If automatic line feed is disabled, any bytes over the maximum are lost. If the maximum is exceeded and automatic line feed is enabled, a line feed (LF) is forced and the remaining plot data are printed as text on the next line.

- The plot mode command may occur anywhere in the line, but plot speed may decrease if it is not at the beginning of the line.

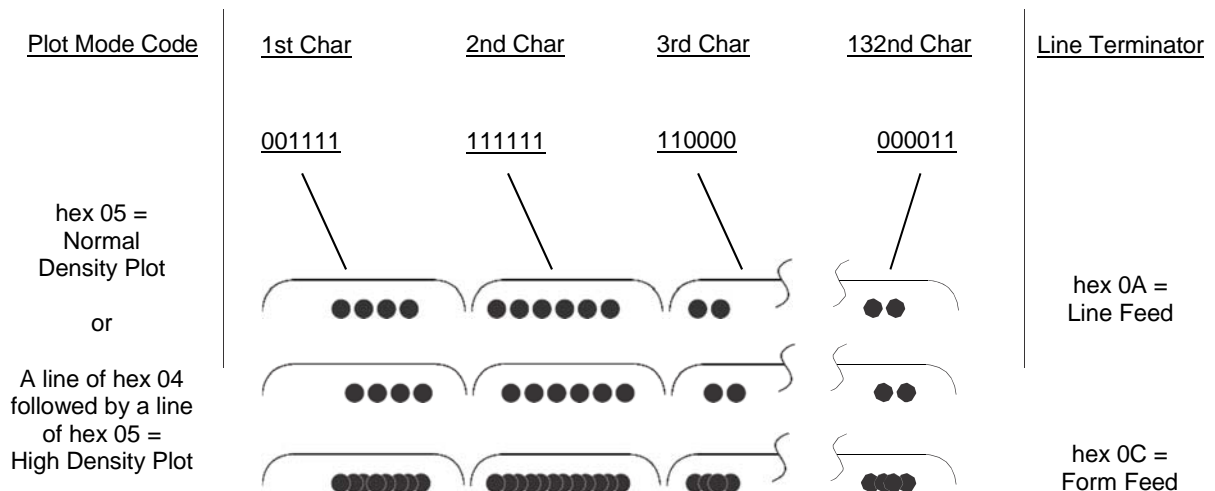

**Figure 35 Plot Data Line Format**

#### **Normal Density Plot Mode Format:**

For normal density plot, the plot line contains: Control Code hex 05, plot data bytes, and a Line Terminator (hex 0A or hex 0C). The control sequence for sending the P-Series Normal Density Plot is as follows:

- Send the plot command code ENQ (hex 05).
- Send the plot data bytes.
- Send a line terminator, either a Line Feed (LF, hex 0A) or a Form Feed (FF, hex 0C). A Carriage Return (CR) may also be used instead of the LF code, provided the Carriage Return has been configured for Carriage Return = Carriage Return + Line Feed (CR = CR + LF).
  - A line feed (hex 0A) used as the line terminator plots the contents of the buffer and advances the paper position a single dot row, based on the vertical density of the current mode.
  - A form feed (hex 0C) used as the line terminator plots the contents of the buffer and advances the paper to the next TOF.
- Regardless of which line terminator code is sent, the emulation will default to the previously selected print mode (font) unless further plot control codes are provided with the data.

#### **Double Density Plot Mode Format:**

For double density plot, the plot line contains: Control Code hex 04, plot data bytes, a Line Terminator (hex 0A or hex 0C), Control Code hex 05, plot data bytes, and a Line Terminator. The control sequence for sending P-Series Double Density Plot is as follows:

- Send the even dot plot control code EOT (hex 04), followed by plot data bytes.
- Send a line terminator, which causes the printer to plot the data bytes; the paper position is *not* advanced in double density plot; the printer now waits for the second line of data.
- Send the odd dot plot control code ENQ (hex 05) and a second line of data, followed by a line terminator.

- a. A line feed (hex 0A) used as the line terminator plots the contents of the buffer and advances the paper position a single dot row, based on the vertical density of the current mode. A CR (if CR = CR + LF is configured) may also be used with the same result.
  - b. A form feed (hex 0C) used as the line terminator plots the data bytes and advances the paper position to the next TOF.
4. Regardless of which line terminator code is sent, the emulation will default to the previously selected print mode (font) unless further plot control codes are provided with the data.

## Plotting the Data

P-Series Plot Mode plots the image from the horizontal bit pattern. Figure 36 duplicates the pattern shown in Figure 30 but is modified for Odd Dot Plot. Eight dot rows are required, two characters per row, six columns per character.

DOT ROW	1 <sup>st</sup> CHARACTER ODD COLUMNS						2 <sup>nd</sup> CHARACTER ODD COLUMNS						1 <sup>st</sup> CHARACTER		2 <sup>nd</sup> CHARACTER	
	1	3	5	7	9	11	1	3	5	7	9	11	ASCII	DECIMAL	ASCII	DECIMAL
	1	3	5	7	9	11	1	3	5	7	9	11				
1		○			○								*	42	@	64
2	○				○		○							73	A	65
3			○	○	○								\	92	@	64
4		○			○								*	42	@	64
5	○				○		○							73	A	65
6			○	○	○								\	92	@	64
7		○			○									42	@	64
8	○				○		○							73	A	65

Figure 36 Odd Dot Plot Pattern Plan

The following program uses the Odd Dot Plot control code to produce the image. The image is printed 25 times as shown in Figure 37. An entire dot row is plotted in one printing pass. Consequently, the first row of all 25 images is printed in one pass, followed by the second row, etc., until all rows have been printed.

```

10      LPRINT "Odd Dot Plot"
20      FOR I=1 TO 8
30      READ R1
40      READ R2
50      LPRINT CHR$(5);
60      FOR N=1 TO 25
70      LPRINT CHR$(R1);CHR$(R2);
80      NEXT N
90      LPRINT
100     NEXT I
110     DATA 42, 64, 73, 65, 92, 64, 42, 64, 73, 65, 92, 64, 42, 64, 73,
120     DATA 65
120     LPRINT

```

**Odd Dot Plot**  
 茶

Figure 37 Sample Odd Dot Plot

## Exiting from P-Series/P-Series XQ Variant Plot Mode

When returning to the print mode from the P-Series Plot Mode, an extra line feed should be included in the data stream to maintain proper print line registration relative to the last line of plot graphics. If the extra line feed is not included, the first character line after the graphics data may be truncated, as shown in Figure 38.

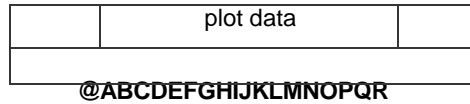

A text line follows plot data, preceded by a single line terminator code. (Text characters may extend into the range of the previously printed plot line and appear truncated.)

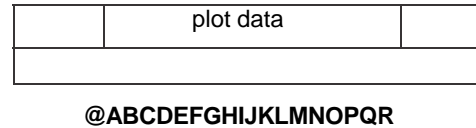

A text line follows plot data, but is preceded by an additional line terminator or LF code. (Characters are printed at full height.)

Figure 38 Truncated Character Line

## Combining Graphics and Text

You can combine graphics and characters (text) on the same page in two ways:

- Use Bit Image graphics or Plot mode to produce characters as well as graphics
- A combination of text (not plot) and graphics can be mixed on the same page within all protocols.

Text and graphics can be mixed on the same line, however, only by using the Bit Image graphics in the Serial Matrix, Epson, or Proprinter XL protocols.

Any character or symbol can be created in the Plot mode or with Bit Image graphics simply by addressing and plotting the appropriate dot positions.

Either Bit Image or Plot mode graphics can be mixed with text within the page on a line by line basis. Each line of graphics data must include a graphics control code or the emulation will automatically default to the print mode. Using Bit Image graphics, it is possible to use the print mode to produce text on one print pass followed by a print pass to produce graphics on the same line; however, text characters can be affected by the Bit Image data when combined on the same line.

The illustration on the following page shows the plot data byte dot patterns that are referenced in the description of P-Series plot mode on page 220.



## Plot Data Byte Dot Patterns

BINARY	OCT	DEC	HEX	ASCII	2 4 6 8 10 12 1 3 5 7 9 11	BINARY	OCT	DEC	HEX	ASCII	2 4 6 8 10 12 1 3 5 7 9 11	BINARY	OCT	DEC	HEX	ASCII	2 4 6 8 10 12 1 3 5 7 9 11
0100000	040	32	20	Space		1000000	100	64	40	@		1100000	140	96	60	`	
0100001	041	33	21	!		1000001	101	65	41	A		1100001	141	97	61	a	
0100010	042	34	22	"		1000010	102	66	42	B		1100010	142	98	62	b	
0100011	043	35	23	#		1000011	103	67	43	C		1100011	143	99	63	c	
0100100	044	36	24	\$		1000100	104	68	44	D		1100100	144	100	64	d	
0100101	045	37	25	%		1000101	105	69	45	E		1100101	145	101	65	e	
0100110	046	38	26	&		1000110	106	70	46	F		1100110	146	102	66	f	
0100111	047	39	27	'		1000111	107	71	47	G		1100111	147	103	67	g	
0101000	050	40	28	(		1001000	110	72	48	H		1101000	150	104	68	h	
0101001	051	41	29	)		1001001	111	73	49	I		1101001	151	105	69	i	
0101010	052	42	2A	*		1001010	112	74	4A	J		1101010	152	106	6A	j	
0101011	053	43	2B	+		1001011	113	75	4B	K		1101011	153	107	6B	k	
0101100	054	44	2C	,		1001100	114	76	4C	L		1101100	154	108	6C	l	
0101101	055	45	2D	-		1001101	115	77	4D	M		1101101	155	109	6D	m	
0101110	056	46	2E	.		1001110	116	78	4E	N		1101110	156	110	6E	n	
0101111	057	47	2F	/		1001111	117	79	4F	O		1101111	157	111	6F	o	
0110000	060	48	30	0		1010000	120	80	50	P		1110000	160	112	70	p	
0110001	061	49	31	1		1010001	121	81	51	Q		1110001	161	113	71	q	
0110010	062	50	32	2		1010010	122	82	52	R		1110010	162	114	72	r	
0110011	063	51	33	3		1010011	123	83	53	S		1110011	163	115	73	s	
0110100	064	52	34	4		1010100	124	84	54	T		1110100	164	116	74	t	
0110101	065	53	35	5		1010101	125	85	55	U		1110101	165	117	75	u	
0110110	066	54	36	6		1010110	126	86	56	V		1110110	166	118	76	v	
0110111	067	55	37	7		1010111	127	87	57	W		1110111	167	119	77	w	
0111000	070	56	38	8		1011000	130	88	58	X		1111000	170	120	78	x	
0111001	071	57	39	9		1011001	131	89	59	Y		1111001	171	121	79	y	
0111010	072	58	3A	:		1011010	132	90	5A	Z		1111010	172	122	7A	z	
0111011	073	59	3B	;		1011011	133	91	5B	[		1111011	173	123	7B	{	
0111100	074	60	3C	<		1011100	134	92	5C	\		1111100	174	124	7C		
0111101	075	61	3D	=		1011101	135	93	5D	]		1111101	175	125	7D	}	
0111110	076	62	3E	>		1011110	136	94	5E	^		1111110	176	126	7E	~	
0111111	077	63	3F	?		1011111	137	95	5F	_		1111111	177	127	7F	Delete	



# 9 *Vertical Page Formatting*

## Overview

Rapid vertical paper movement is called slewing. A vertical format unit (VFU) is a program you load into the printer that enables it to slew paper to preset locations on a page.

On your printer, LF commands and other commands that produce blank lines are accumulated and moved in one efficient paper motion. The VFUs are maintained for compatibility with earlier applications.

Following an introductory overview of how to plan a vertical page format, the following four methods of vertical formatting are described in this chapter:

- **Vertical tab table.** The IBM Proprinter III XL, Epson FX, and Serial Matrix emulations each contain a vertical tab table. It is a set of programmed vertical tabs.
- **Electronic Vertical Format Unit (EVFU).** The P-Series and P-Series XQ Variant emulations provide the EVFU capability.
- **Dataproducts<sup>®</sup> Direct Access Vertical Format Unit (DVFU).** The P- Series and P-Series XQ Variant emulations provide the DVFU capability.
- **Centronics<sup>®</sup> Vertical Format Unit (CVFU).** The P-Series and P-Series XQ Variant emulations provide the CVFU capability.

## Planning a Vertical Page Format

Vertical page formatting with a VFU such as the EVFU consists of four steps:

1. Select the type of vertical format you want to use. This is covered in the next section.
2. Design the form, determining the spacing and channel assignments for every line. Channel assignments are discussed in the VFU sections.
3. Determine the programming sequence. The format of the sequence depends on the type of VFU you select and is discussed in each VFU section of this chapter.
4. Send the programming sequence to the printer in the host data stream. This loads the VFU program.

Some VFUs require the Paper Instruction (PI) line normally associated with the Dataproducts parallel interface.

### VFU Characteristics

Keep in mind the following information when programming and using a VFU:

**Elongated Characters** – You can use elongated (double high) characters in VFU programs. The VFU automatically counts one line of elongated characters as two character lines.

**VFU Not Loaded** – If the VFU is not loaded, the printer performs a single line feed in response to VFU commands.

**Paper Runaway Protection** – If the VFU memory is loaded and a channel code is sent that was not previously loaded, the printer moves the paper a single line feed.

**Line Spacing** – The printer can use either 6 or 8 lines per inch (lpi) spacing. These VFUs calculate the forms length by line density selected. The 6 and 8 lpi spacing may be mixed on the same form, but should be done carefully.

**Form Feed** – A form feed sent from the operator panel or a command from the host moves the paper to the first channel 1, which is the top of form.

**Vertical Tab** – A VT command moves the paper to the next channel 12. If a channel 12 is not loaded, a line feed will occur.

## Vertical Tab Table for Proprinter, Epson, and Serial Matrix

The IBM Proprinter III XL, Epson FX, and Serial Matrix emulations each contain a vertical tab table. It is a set of programmed vertical tabs. Various lines of the form are assigned vertical tabs, which are then accessed by control code for rapid paper advancement to the tab position.

Two control codes are used for vertical tabbing: ESC B sets single channel vertical tabs, and VT executes a vertical tab. These codes are described in Chapters 2, 3, and 5, which cover the Proprinter, Epson, and Serial Matrix emulations, respectively. The Epson emulation also has ESC / to select one of eight tab channels and ESC b to set the tabs in a particular channel.

### Executing Vertical Tabs

The vertical tab execute code is VT. It prints the contents of the print buffer (if data are in the buffer) and causes paper movement to the next predefined vertical tab position. If a tab position is not defined, the paper is moved to the next line at the current line spacing. If a tab position is at the current line, the paper is moved to the next tab position. If no tab positions are defined between the current line and the end of the form, the paper moves to the next TOF.

### Vertical Tab Positions

Vertical tab positions are set by line number. A maximum of 16 vertical tab positions can be set on the form. A sample format is shown in Figure 39.

The first vertical tab is set at line 6 for part number data, a second tab is set at line 8 for part name data, and a third tab is set at line 14 for quantity data. The ESC B code assigns the vertical tabs to the lines of the form. Once the tab positions are set, sending the vertical tab execute code (VT) causes the paper (currently at the top-of-form position) to advance to the first tab position for PART NUMBER data. Sending another VT moves the paper to the second tab position for PART NAME, followed by a third VT to access the third tab position for QUANTITY data.

Form Data	Form Line Number	Vertical Tab
	1	Top of Form
	2	
	3	
	4	
	5	
PART NUMBER	6	Tab 1
	7	
PART NAME	8	Tab 2
	9	
	10	
	11	
	12	
	13	
QUANTITY	14	Tab 3
	15	
	"	
	20	

Figure 39 Example of Vertical Tab Positions

## EVFU for P-Series and P-Series XQ Variant Emulations

The EVFU may be selected in P-Series or the P-Series XQ Variant protocol. The EVFU provides 14 or 16 channels to identify up to 192 lines depending on the state of the paper instruction line. The programming sequence is 1) start load code; 2) line identification code; and 3) end load code.

### Start Load Code - Hex 1E Or 6E

The start load code clears and initializes the EVFU memory for the memory load program. The start load code is hex 1E when the PI line is disabled (low) or hex 6E when the PI line is enabled (high).

### Channel Assignment

The EVFU memory has the capacity for 192-line forms. The first line identification code (channel code) in the memory load program defines the first line on the form; the second line identification code defines the second line on the form, etc. Each line must have a line identification code. Filler channel codes are used for lines that will not be accessed by the print program. Any channel code can be used as a filler except channel code 1, which is reserved for the top-of-form, and channel code 12, which is reserved as the vertical tab channel. The same filler channel code can be repeated as necessary for any number of lines.

**Channel 1** - The top-of-form code, reserved as the first line on the form or the first line printed (top-of-form position). The operating program sends the channel 1 code to advance to the top of the next form. After the memory is loaded, a Form Feed code (FF, hex 0C) will move the paper to the next channel 1 (top-of-form).

**Channels 2 through 11, 13 and 14** - Used as general channel codes (line identification codes) or filler channels. Each line on the form must be identified by a channel code. When the operating program sends the channel code, the paper advances to the line identified by the channel code. Lines not used by the operating program must be identified by filler channels (unused channel codes).

**Channel 12** - Reserved as the Vertical Tab channel. The Vertical Tab code (VT, hex 0B) prints any data in the print buffer and rapidly slews the paper to the next line identified by the channel 12 code. If channel 12 is not loaded in the EVFU memory, a single line feed will be executed when a VT code is sent.

**Channel 15 and 16** - Used as general channel codes or filler channels only when the VFU is accessed by the PI line. In an EVFU form that does not use the PI line, the codes for Channels 15 and 16 function as the Start Load and End Load codes.

### **End Load - Hex 1F or 6F**

The end load code terminates the memory load program. The end load code is hex 1F when the PI line is disabled (low) or hex 6F when the PI line is high. Channel codes in excess of 192 channels received prior to the end load code are discarded.

### **Using the EVFU**

Once the EVFU program has been enabled and loaded, sending the appropriate channel code to the printer will cause any data in the buffer to print and will position the paper to the next line on the form having the specified channel number assigned in EVFU memory.

For a data byte to be recognized as an EVFU instruction, the following criteria must be met:

1. PI line must be enabled and set high; and
2. Data bit 5 must be 0 (not set).

**OR:**

1. PI line must be disabled or low; and
2. Data bit 5 must be 1 (set).

Given these conditions, the lower four bits of a byte will specify the EVFU channel number. Table 72 lists the EVFU channels and their equivalent data bytes with the PI line enabled; Table 73 lists the EVFU channel and their equivalent data bytes with the PI line disabled.

**Table 72 P-Series EVFU Codes - PI Line Enabled**

ASCII			Data Bits									Channel
Hex	Dec.	Code	PI	8	7	6	5	4	3	2	1	
00	0	NUL	1	X	X	X	0	0	0	0	0	1 (TOF)
01	1	SOH	1	X	X	X	0	0	0	0	1	2
02	2	STX	1	X	X	X	0	0	0	1	0	3
03	3	ETX	1	X	X	X	0	0	0	1	1	4
04	4	EOT	1	X	X	X	0	0	1	0	0	5
05	5	ENQ	1	X	X	X	0	0	1	0	1	6
06	6	ACK	1	X	X	X	0	0	1	1	0	7
07	7	BEL	1	X	X	X	0	0	1	1	1	8
08	8	BS	1	X	X	X	0	1	0	0	0	9
09	9	HT	1	X	X	X	0	1	0	0	1	10
0A	10	LF	1	X	X	X	0	1	0	1	0	11
0B	11	VT	1	X	X	X	0	1	0	1	1	12 (VT)
0C	12	FF	1	X	X	X	0	1	1	0	0	13
0D	13	CR	1	X	X	X	0	1	1	0	1	14
0E	14	SO	1	X	0	0	0	1	1	1	0	15
0F	15	SI	1	X	0	0	0	1	1	1	1	16
6E	110	n	1	X	1	1	0	1	1	1	0	Start Load
6F	111	o	1	X	1	1	0	1	1	1	1	End Load

(X = Undefined, 0, or 1) (1 = High) (0 = Low)

**Table 73 P-Series EVFU Codes - PI Line Enabled**

ASCII		Data Bits									Channel
Hex	Dec.	Code	8	7	6	5	4	3	2	1	
10	16	DLE	0	0	0	1	0	0	0	0	1 (TOF)
11	17	DC1	0	0	0	1	0	0	0	1	2
12	18	DC2	0	0	0	1	0	0	1	0	3
13	19	DC3	0	0	0	1	0	0	1	1	4
14	20	DC4	0	0	0	1	0	1	0	0	5
15	21	NAK	0	0	0	1	0	1	0	1	6
16	22	SYN	0	0	0	1	0	1	1	0	7
17	23	ETB	0	0	0	1	0	1	1	1	8
18	24	CAN	0	0	0	1	1	0	0	0	9
19	25	EM	0	0	0	1	1	0	0	1	10
1A	26	SUB	0	0	0	1	1	0	1	0	11
1B	27	ESC	0	0	0	1	1	0	1	1	12 (VT)
1C	28	FS	0	0	0	1	1	1	0	0	13
1D	29	GS	0	0	0	1	1	1	0	1	14
1E	30	RS	0	0	0	1	1	1	1	0	Start Load
1F	31	US	0	0	0	1	1	1	1	1	End Load

(X = Undefined, 0, or 1) (1 = High) (0 = Low)

### Clearing the EVFU Memory

The following actions will reset (clear) the EVFU memory:

1. Sending only the start load code.
2. Sending a start load code followed immediately by an end load code.
3. A second start load code is received, resulting in reinitialization of the EVFU. (This allows the host data to be restarted.)

When the EVFU memory is cleared, the forms length returns to the previously set value and the current print position becomes the top-of-form (TOF).

### Relative Line Slewing

Another method of moving paper using the PI line results in vertical slews of a specified number of lines within the form relative to the current print line (rather than slewing to a specific line). For this to occur, three criteria must be met:

1. The PI line must be enabled and set high;
2. Data bit 5 must be 1 (set); and



3. The EVFU must be the selected Vertical Format Unit.

The Slew Relative configuration and the status of data bits 1-4 determine the number of lines slewed as described in Table 74.

**NOTE:** The state of data bit 5 is the difference between line slewing and using the interface lines as EVFU channel codes.

As long as the EVFU is selected, this type of vertical paper motion will occur regardless of whether the EVFU memory is loaded or not.

If the Double High for One Line attribute is active,  $n+1$  lines will be slewed rather than  $n$  lines.

**Table 74 P-Series EVFU Line Slewing**

Hex	ASCII		PI	Data Bits								Lines Slewed
	Dec.	Code		8	7	6	5	4	3	2	1	
10	16	DLE	1	X	X	X	1	0	0	0	0	1
11	17	DC1	1	X	X	X	1	0	0	0	1	2
12	18	DC2	1	X	X	X	1	0	0	1	0	3
13	19	DC3	1	X	X	X	1	0	0	1	1	4
14	20	DC4	1	X	X	X	1	0	1	0	0	5
15	21	NAK	1	X	X	X	1	0	1	0	1	6
16	22	SYN	1	X	X	X	1	0	1	1	0	7
17	23	ETB	1	X	X	X	1	0	1	1	1	8
18	24	CAN	1	X	X	X	1	1	0	0	0	9
19	25	EM	1	X	X	X	1	1	0	0	1	10
1A	26	SUB	1	X	X	X	1	1	0	1	0	11
1B	27	ESC	1	X	X	X	1	1	0	1	1	12
1C	28	FS	1	X	X	X	1	1	1	0	0	13
1D	29	GS	1	X	X	X	1	1	1	0	1	14
1E	30	RS	1	X	0	0	1	1	1	1	0	15
1F	31	US	1	X	0	0	1	1	1	1	1	16

(X = Undefined, 0, or 1) (1 = High) (0 = Low)

# DVFU: Dataproducts Direct Access Vertical Format Unit

The DVFU may be selected in the P-Series protocol mode and is generally used when the Dataproducts interface is selected. A maximum of 12 channels can be assigned to each physical line of a form, up to 143 lines. You assign channel numbers to each line on the form. When the host sends the channel codes to the printer, the paper slews to the next corresponding line.

The programming sequence is: Start Load code, channel assignments, and End Load code.

## Start Load Code - Hex 6C, 6D, or 6E

The DVFU Start Load code of hex 6E with the PI (Paper Instruction) line high starts the DVFU memory load routine. The Start Load code hex 6C may be used in place of hex 6E, in which case the line spacing is set to 6 lpi. Similarly, if you use the Start Load code hex 6D, the line spacing is set to 8 lpi. Line spacing does not change if you use code hex 6E.

## Channel Assignments

Following the Start Load code, all data bytes received are interpreted as channel assignment data until the End Load code is received. The current line corresponds to the first line in the DVFU, and the first line is the top of form and must have Channel 1 set, or the entire load sequence is ignored. The last channel 12 loaded is assigned as Bottom of Form (BOF). If skip-over perforation is enabled, slewing occurs from BOF to TOF.

A maximum of 12 channels can be assigned to one physical line on the form. Two eight-bit data bytes (DVFU characters) are required per line. As shown in Table 75, the least significant 6 bits of the first data byte are used to assign channels 1 through 6; the least significant 6 bits of the second data byte are used to assign channels 7 through 12. If a bit is set, the corresponding channel is assigned.

Each line on the form requires two bytes. For lines not requiring a channel identification, the two bytes should not contain channel assignments.

This procedure can be continued for a maximum of 143 lines (286 DVFU bytes). The DVFU ignores anything more than 286 bytes until the End Load code is received; if 572 bytes are received without an End Load code, the End Load code is “forced” and the load routine is terminated.

## End Load Code - Hex 6F

The DVFU End Load code is hex 6F with the PI line high. This terminates the DVFU memory load routine. If DVFU was enabled via the control panel, the letter “L” (for loaded) appears in the lower right hand corner of the liquid crystal display.

**Table 75 DVFU Channel Assignment**

First Data Byte		yte	
Bit #	Channel #	Bit #	Channel #
8	undefined	8	undefined
7	undefined	7	undefined
6	6	6	12
5	5	5	11
4	4	4	10
3	3	3	9
2	2	2	8
1 (LSB)	1 (TOF)	1 (LSB)	7

## Using the DVFU

When the DVFU program is enabled and loaded, an “E” appears in the upper right hand corner of the liquid crystal display, and an “L” appears in the lower right hand corner. The program can then be accessed by sending the appropriate channel instruction to the printer. The paper slews to the next physical line on the form having the specified channel number assigned in the DVFU memory. This is accomplished only with the PI line held high. For a data byte to be recognized as a DVFU channel instruction, the following criteria must be met:

1. PI line must be high.
2. Data bit 5 must be 0 (not set).

Given these two conditions, the lower 4 bits of a byte specify the DVFU channel number. Table 76 lists DVFU channels and their equivalent data bytes.

## Clearing the DVFU Memory

The following actions reset (clear) the DVFU memory.

1. Only Start Load and End Load codes are sent (no channel assignment data).
2. An odd number of DVFU characters (channel assignment data) are sent (detected after the End Load code is received). Remember, two data bytes are required per line.
3. A second Start Load code is received, resulting in reinitialization of the DVFU memory routine. This allows the routine to be restarted.

**Table 76 DVFU Channel Instruction**

Channel Selected	PI Line	Bits of Data Byte							
		8	7	6	5	4	3	2	1
1	1	X	X	X	0	0	0	0	0
2	1	X	X	X	0	0	0	0	1
3	1	X	X	X	0	0	0	1	0
4	1	X	X	X	0	0	0	1	1
5	1	X	X	X	0	0	1	0	0
6	1	X	X	X	0	0	1	0	1
7	1	X	X	X	0	0	1	1	0
8	1	X	X	X	0	0	1	1	1
9	1	X	X	X	0	1	0	0	0
10	1	X	X	X	0	1	0	0	1
11	1	X	X	X	0	1	0	1	0
12	1	X	X	X	0	1	0	1	1
(X = Undefined, 0, or 1) (1 = High) (0 = Low)									

## Relative Line Slewing

Another method of moving paper using the PI line results in vertical slews of a specified number of lines within the form (rather than slewing to a specific line). For this to occur, three criteria must be met:

1. PI line must be high;
2. Data bit 5 must be 1 (set);
3. The DVFU must be the selected vertical format unit.

If these criteria are met, the paper slews a specific number of lines, based on the status of data bits 1-4 as shown in Table 77. As long as the DVFU is selected, this type of vertical paper motion occurs regardless of whether the DVFU memory is loaded or not.

**NOTE:** When using Relative Line Slewing with Elongated (Double High) print, the paper is moved  $n + 1$  lines rather than  $n$  lines.

**Table 77 P-Series DVFU Line Slewing**

Number of Lines Slewed	PI Line	Bits of Data Byte							
		8	7	6	5	4	3	2	1
0	1	X	X	X	1	0	0	0	0
1	1	X	X	X	1	0	0	0	1
2	1	X	X	X	1	0	0	1	0
3	1	X	X	X	1	0	0	1	1
4	1	X	X	X	1	0	1	0	0
5	1	X	X	X	1	0	1	0	1
6	1	X	X	X	1	0	1	1	0
7	1	X	X	X	1	0	1	1	1
8	1	X	X	X	1	1	0	0	0
9	1	X	X	X	1	1	0	0	1
10	1	X	X	X	1	1	0	1	0
11	1	X	X	X	1	1	0	1	1
12	1	X	X	X	1	1	1	0	0
13	1	X	X	X	1	1	1	0	1
14	1	X	X	X	1	1	1	1	0
15	1	X	X	X	1	1	1	1	1

(X = Undefined, 0, or 1) (1 = High) (0 = Low)

# CVFU: Centronics Vertical Format Unit

The CVFU may be selected in P-Series protocol. The CVFU provides 12 channels to identify up to 126 lines, responding to Centronics Direct Access Format Unit control codes. This VFU does not make use of the PI (Paper Instruction) line for either loading or executing.

The programming sequence is 1) start load code; 2) line identification code; and 3) end load code.

## Start Load Code - Hex 1D

The Start Load Code clears and initializes the CVFU memory for the memory load program. The Start Load Code is hex 1D. Data received after the Start Load Code are interpreted as line identification codes until the End Load Code is received.

## Channel Assignments

Following the Start Load Code, all data bytes received are interpreted as channel assignment data until the End Load Code is received.

A maximum of 12 channels can be assigned to one physical line on the form. Two eight-bit data bytes (CVFU characters) are required per line. As shown in Table 78, the least significant 6 bits of the first data byte are used to assign channels 1 through 6; the least significant 6 bits of the second data byte are used to assign channels 7 through 12. If a bit is set, the corresponding channel is assigned.

Each line on the form requires two bytes. For lines not requiring a channel identification, the two bytes should not contain channel assignments.

This procedure can be continued for a maximum of 126 lines (252 CVFU bytes). The CVFU memory is cleared if more than 252 bytes are received before the End Load Code.

**CH 1 TOF.** The first channel, line 1 of the form, must be assigned channel 1, top-of-form and channel 2 must not be defined in this first byte (byte one, bit 2 must be 0) or the entire load sequence is ignored and the memory reset. After the memory is loaded, a Form Feed code (FF, hex 0C) moves the paper to the next channel 1 (top-of-form).

After the channel assignment on the last line of the form, another channel assignment must be sent with the top-of-form bit set (called the "dummy TOF"). This channel assignment code does not count as a line of the form. All data received after the dummy TOF are ignored until the End Load Code is received. Data received after the dummy TOF are counted as part of the maximum allowed (126 lines, 252 bytes).

**CH 2 VT.** Channel 2 is used as the vertical tab channel. After the memory is loaded, a Vertical Tab (VT, hex 0B) moves the paper to the next channel 2. If a VT code is received but channel 2 is not loaded, the paper advances to the next TOF position. If a VT code is received but the CVFU is not selected or not loaded, a single line feed occurs.

## End Load Code - Hex 1E

The CVFU End Load Code is hex 1E. This terminates the CVFU memory load routine.

**Table 78 CVFU Channel Assignment**

First Data Byte			Second Data Byte		
Binary Value	Bit #	Channel #	Binary Value	Bit #	Channel #
128	8	undefined	128	8	undefined
64	7	Set High (1)	64	7	Set High (1)
32	6	6	32	6	12
16	5	5	16	5	11
8	4	4	8	4	10
4	3	3	4	3	9
2	2	2 (VT)	2	2	8
1	1 (LSB)	1 (TOF)	1	1 (LSB)	7

**Using the CVFU - Hex 1F**

When the CVFU program is enabled and loaded, an “E” appears in the upper right hand corner of the liquid crystal display, and an “L” appears in the lower right hand corner. Sending an appropriate channel code to the printer causes any data in the buffer to print and slews the paper to the next line on the form having the specified channel number assigned in CVFU memory. For a data byte to be recognized as a CVFU channel instruction, the following criteria must be met:

1. A hex 1F code must have been received; and
2. Data bit 5 must be 0 (not set).

Given these conditions, the lower 4 bits of a byte specify the CVFU channel number. Table 79 lists CVFU channels and their equivalent data bytes.

**Table 79 CVFU Command Codes**

Hex	ASCII		Data Bits								CVFU Channel
	Dec.	Code	8	7	6	5	4	3	2	1	
1F	31	US	X	X	X	1	1	1	1	1	Start Execute
01	1	SOH	X	X	X	0	0	0	0	1	1
02	2	STX	X	X	X	0	0	0	1	0	2
03	3	ETX	X	X	X	0	0	0	1	1	3
04	4	EOT	X	X	X	0	0	1	0	0	4
05	5	ENQ	X	X	X	0	0	1	0	1	5
06	6	ACK	X	X	X	0	0	1	1	0	6
07	7	BEL	X	X	X	0	0	1	1	1	7
08	8	BS	X	X	X	0	1	0	0	0	8
09	9	HT	X	X	X	0	1	0	0	1	9
0A	10	LF	X	X	X	0	1	0	1	0	10
0B	11	VT	X	X	X	0	1	0	1	1	11
0C	12	FF	X	X	X	0	1	1	0	0	12
(X = Undefined, 0, or 1) (1 = High) (0 = Low)											

### Clearing the CVFU Memory

The following actions reset (clear) the CVFU memory:

1. Only the Start Load and End Load Codes are sent (no channel data).
2. An odd number of CVFU characters (channel assignment data) are sent (detected after the end load code is received). Remember, two data bytes are required per line.
3. More than 126 lines (252 bytes) are sent without specifying the dummy TOF.
4. The first byte sent after the start load does not specify TOF or channel 2 is specified in the first byte.
5. Bit 7 is low during the CVFU load.
6. A second start load code is received, resulting in reinitialization of the CVFU. (This allows the host data to be restarted.)

When the CVFU memory is cleared, the forms length returns to the previously set value and the current print position becomes the top-of-form (TOF).

### Relative Line Slewing

Another method of moving paper using the PI line results in vertical slews of a specified number of lines within the form relative to the current print line (rather than slewing to a specific line). For this to occur, three criteria must be met:

1. Code hex 1F must be received.
2. Data bit 5 must be 1 (set).

3. The CVFU must be the selected Vertical Format Unit.

The Slew Relative configuration and the status of data bits 1-4 determine the number of lines slewed as described in Table 80. (Note that the state of data bit 5 is the difference between line slewing and using the interface lines as CVFU channel codes.) As long as the CVFU is selected, this type of vertical paper motion occurs regardless of whether the CVFU memory is loaded or not.

If the Double High for One Line attribute is active, paper slews  $n + 1$  lines rather than  $n$  lines.

**Table 80 CVFU Line Slewing**

ASCII			Data Bits								CVFU Channel
Hex	Dec.	Code	8	7	6	5	4	3	2	1	
10	16	DLE	0	0	0	1	0	0	0	0	0 = CR*
11	17	DC1	0	0	0	1	0	0	0	1	1
12	18	DC2	0	0	0	1	0	0	1	0	2
13	19	DC3	0	0	0	1	0	0	1	1	3
14	20	DC4	0	0	0	1	0	1	0	0	4
15	21	NAK	0	0	0	1	0	1	0	1	5
16	22	SYN	0	0	0	1	0	1	1	0	6
17	23	ETB	0	0	0	1	0	1	1	1	7
18	24	CAN	0	0	0	1	1	0	0	0	8
19	25	EM	0	0	0	1	1	0	0	1	9
1A	26	SUB	0	0	0	1	1	0	1	0	10
1B	27	ESC	0	0	0	1	1	0	1	1	11
1C	28	FS	0	0	0	1	1	1	0	0	12
1D	29	GS	0	0	0	1	1	1	0	1	13
1E	30	RS	0	0	0	1	1	1	1	0	14
1F	31	US	0	0	0	1	1	1	1	1	15

(X = Undefined, 0, or 1) (1 = High) (0 = Low)  
 \*treated as CR = CR; refer to the Carriage Return control code on page 98.



# 10 Downloading Characters

## Downloading Character (P-Series and Serial Matrix Only)

You can create unique characters and download them from the host computer to the printer's working memory (RAM) using the P-Series or Serial Matrix emulations. Unless you save them in non-volatile flash memory via the control panel, downloaded characters must be reloaded every time printer power is recycled or RAM is cleared.

Three commands are involved in downloading a character:

1. **SFCC c** - defines a new character in a specific font and pitch.
2. **SFCC V** - (Download a Language) store a new character in an *unused* address or replace an existing character in the Character Library. See Download a Character Set Overlay on page 250.
3. **SFCC RX** - (Character Set Select: International Languages) when you want to access a downloaded language.

When using normal character sets (Standard Sets, Arabic Sets, Cyrillic Sets, European Sets, Greek Sets, Hebrew Sets, Turkish Sets, etc), the E terminator is the data terminator in the commands, as specified in Table 81.

When UTF-8 is enabled, the U terminator is the data terminator in the commands, as specified in Table 81.

Table 81 E and U Terminator Support

	E Terminator	U Terminator
SFCC c	supported	supported
SFCC V	supported	not supported
SFCC RX	supported	supported

### Procedure

The command **SFCC c** is followed by ASCII characters:

**When using normal character sets:** *PPSSSSSEA;data*

**When UTF-8 is enabled:** *PPSSSSSUA;data*

where:

*PP* the font and pitch the downloaded character will print at.

*SSSSS* When using normal character sets (Standard Sets, Arabic Sets, Cyrillic Sets, European Sets, Greek Sets, Hebrew Sets, Turkish Sets, etc.), this parameter is the decimal value between 0 and 65535 which represents the symbol point of the new character in the Character Library (Appendix C). The symbol point represents a character location using a Printronix number. No leading zeros are required.

When UTF-8 is enabled, this parameter is the decimal value between 0 and 65535 which represents the Unicode of a character. No leading zeros are required.

E or U the terminator following this numeric field.

Using the E terminator allows you to store a character in an unused address or replace an existing character in the Character Library (page 266). Using the U terminator allows you to store a character in an unused address or replace an existing character in the Unicode chart. If a character is assigned to an unused address, you must use this control code in conjunction with SFCC V (Downloading a Language) to assign the downloaded character to a printable position. However, if a downloaded character replaces an existing character in a font and pitch, that character will be changed in every character set or international language in which that character was used. SFCC V does not support the U terminator because UTF-8 allows access to every Unicode address.

A; the single-character attribute flag identifying whether the character contains descenders (a portion of the character descends below the bottom of the print line), extenders (2 dot rows near the bottom of the character are repeated until what would be the next line boundary at 6 lpi), or ascenders (a portion of the character extends above the top of a normal character). Extenders are used for graphics characters. See Table 82 for the accepted values for A. The semicolon (;) is the hexadecimal data terminator.

**Table 82 Ascenders, Descenders and Extenders Attribute Flags**

A	Attribute Flags
0	No attributes
2	Descenders
6	Extenders
8	Ascenders
A	Ascenders + Descenders
E	Ascenders, Descenders and Extenders

*data* the data values for each dot column of the character cell. The Least Significant Bit is the bottom-most dot of the character. The size of the character cell is determined by the selected font and pitch *PP* and the attributes *A* applied to it. If there are not enough data to define each dot column in the character cell, any subsequent bytes are used to complete the dot column data; if more data are sent than expected, the excess are treated as printable data. The character size is determined using the data in Table 84. The semicolon (;) is the hexadecimal data terminator and must follow each dot column entry.

You can create six or more characters, depending on the memory requirements for each character. You can save downloaded characters into the printer power-up configuration when the configuration is saved. User- defined characters have priority over standard characters.

The largest permitted symbol point is 65,535 decimal; values greater than 65,535 are invalid. Non-numeric characters in a numeric data field also render the character invalid. If the defined character format is invalid, all downloaded characters in working memory are cleared. (Characters saved in nonvolatile memory are not affected.)

The Extend attribute causes the character to be extended to what would be the next line boundary at 6 lpi. This attribute is useful for graphics characters that must connect to graphics characters on the next line. The Extend attribute is achieved by repeating the lowest-most two dot rows. Characters with the Extend attribute are assumed to be characters with descenders.

Table 83 shows by font the number of dot rows and the number of times the dot rows are repeated when the Extend attribute is used.

**Table 83 Extended Character Attributes**

Font	Dotrows Extended
HS	2
DP	3
NLQ	4
OCR	5

The Ascender attribute causes the characters to extend upward to the previous boundary at 6 dpi by the number of dot rows indicated in Table 83. Care should be taken when using ascenders, as they may cause overlapping dots with the previous line of text. If ascenders are needed for the DP font, 2 bytes per column must be used.

**Table 84 Calculating the Character Size**

Font	Code	Dots Per Inch	bits/col. w/o descenders	additional bits/col. w/o descenders	additional bits/col. w/o ascenders	# of dot columns	Bytes per dot column
HS 10	20	120	5	1	2	12	1
HS 12/13	21 or 22	120	5	1	2	10	1
HS 15/17/20	23 or 24	120	5	1	2	8	1
DP 10	00	120	7	2	3	12	1 or 2
DP 12/13	01 or 02	120	7	2	3	10	1 or 2
DP 15/17/20	03 or 04	120	7	2	3	8	1 or 2
NLQ 10	10	180	9	3	4	18	2
NLQ 12/13	11 or 12	180	9	3	4	15	2
NLQ 15/17/20	13 or 14	180	9	3	4	12	2
NLQ2 10	70	180	9	3	4	18	2
NLQ2 12/13	71	180	9	3	4	15	2
NLQ2 15/17/20	73	180	9	3	4	12	2
OCR-A	50	120	14	2	N/A	12	2
OCR-B	60	120	14	2	N/A	12	2

## Examples

The following examples illustrate the process of creating a character with no attributes, a character with descenders, and a character with extenders.

**NOTE:** If adjacent dots are used to create the character, any line containing the character will print at half the normal speed. Half speed may also occur if a dot is placed in the first or last dot column of the character cell.

### Example 1: Character with No Attributes

**NOTE:** This example illustrates how you can produce OCR characters for a printer using the downloading feature should an OCR reader fail to read standard OCR printed characters.

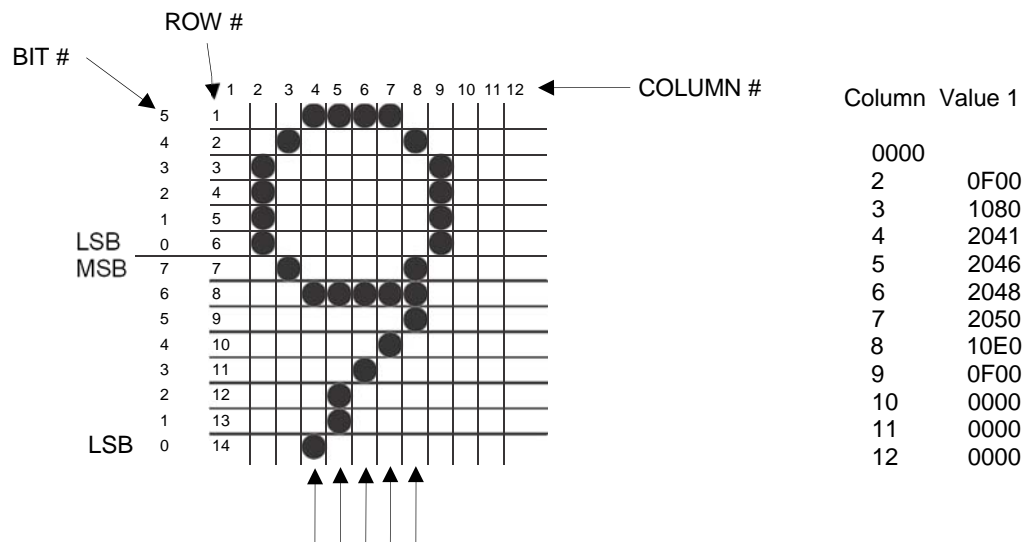

Adjacent dots in rows 1 and 8 may result in half-speed printing of those dot rows.

Selected Font and Pitch: OCR-B 10 cpi.

OCR-B with 10 cpi with no attributes = 12 Columns x 14 bits per column (Table 84)

**Figure 40 Layout of a Character with no Attributes**

The BASIC program to generate this character and a print sample are shown below.

**When using normal character sets:**

(For normal character set examples, refer to page 240.)

```
10 LPRINT CHR$(27); "@";
```

```
20 LPRINT CHR$(27); "c6057E0; 0; ";
```

```
30 LPRINT "F00; 1080; 2041; 2046; 2048; 2050; 10E0; F00; 0; 0; 0; ";
```

```
40 LPRINT CHR$(27); "X60";
```

```
50 LPRINT "99999"
```

**When UTF-8 is enabled:**

```
10 LPRINT CHR$(27); "@";  
20 LPRINT CHR$(27); "c6057U0; 0; ";  
30 LPRINT "F00; 1080; 2041; 2046; 2048; 2050; 10E0; F00; 0; 0; 0; ";  
40 LPRINT CHR$(27); "X60";  
50 LPRINT "99999"
```

**99999**

The command for the character shown in Figure 40 is defined as follows:

**When using normal character sets:**

(For normal character set examples, refer to page 240.)

```
ESC c 6057E0;0;F00;1080;2041;2046;2048;2050;10E0;F00;0;0;0;
```

**When UTF-8 is enabled:**

```
ESC c 6057U0;0;F00;1080;2041;2046;2048;2050;10E0;F00;0;0;0;
```

where:

- ESC c** the control code header introducing the Download a Character command.
- 60** the selected font and pitch code from Table 84 where Code 60 represents OCR font.
- 57E** the address location in the Character Library (Appendix C) where the downloaded character will be sent. E is the decimal field terminator (required after each decimal field). Address 57 contains an existing character which will be replaced by the new character.
- 57U** the address location in the Unicode chart where the downloaded character will be sent. U is the decimal field terminator (required after each decimal field). Address 57 contains an existing character which will be replaced by the new character.

**IMPORTANT** If a downloaded character replaces an existing character in a font and pitch, that character will be changed in every character set or international language in which that existing character was used.

**0;** the single-character attribute flag identifying the character as having no attributes (descenders or extenders). The semicolon (;) is the hexadecimal data terminator.

**0;F00;1080;2041;2046;2048;2050;10E0;F00;0;0;0;**

the ASCII data generated from each column of the character layout in Figure 40.

## Example 2: Character with Descenders

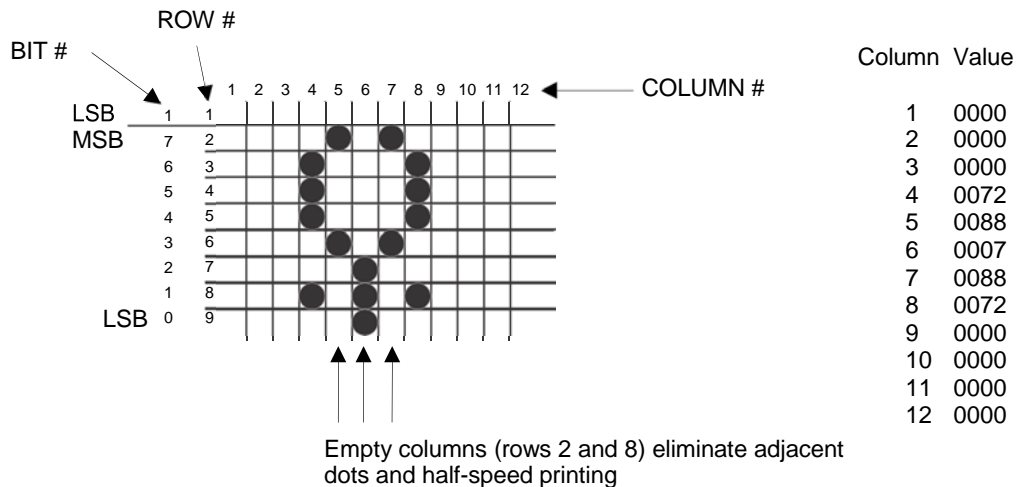

Selected Font and Pitch: DP 10 cpi.

DP with 10 cpi with descenders = 12 Columns x 9 bits per column (Table 84)

**Figure 41 Layout of a Character with Descenders**

The BASIC program to generate this character and a print sample are illustrated below.

### When using normal character sets:

(For normal character set examples, refer to page 240.)

```
10 WIDTH "LPT1:", 255
```

```
20 LPRINT CHR$(27); "@";
```

```
30 LPRINT CHR$(27); "c0090E2; 0; 0; 0; 72; 88; 7; 88; 72; 0; 0; 0; 0; ";
```

```
40 LPRINT CHR$(27); "X00";
```

```
50 LPRINT "ZZZZZ"
```

### When UTF-8 is enabled:

```
10 WIDTH "LPT1:", 255
```

```
20 LPRINT CHR$(27); "@";
```

```
30 LPRINT CHR$(27); "c0090U2; 0; 0; 0; 72; 88; 7; 88; 72; 0; 0; 0; 0; ";
```

```
40 LPRINT CHR$(27); "X00";
```

```
50 LPRINT "ZZZZZ"
```

```
qqqqq
```

The command for the character shown in Figure 41 is as follows:

**When using normal character sets:**

(For normal character set examples, refer to page 240.)

```
ESC c 0090E2;0;0;0;72;88;7;88;72;0;0;0;0;
```

**When UTF-8 is enabled:**

```
ESC c 0090U2;0;0;0;72;88;7;88;72;0;0;0;0;
```

where:

- ESC c** the control code header introducing the Download a Character command.
- 00** the selected font and pitch code from Table 84 where code 00 = DP10
- 90E** the address location in the Character Library (Appendix C) where the downloaded character will be sent. The existing character at address 90 will be replaced with the new character. E is the decimal field terminator (required after each decimal field).
- 90U** the address location in the Unicode chart where the downloaded character will be sent. The existing character at address 90 will be replaced with the new character. U is the decimal field terminator (required after each decimal field).

**IMPORTANT** If a downloaded character replaces an existing character in a font and pitch, that character will be changed in every character set or international language in which that existing character was used.

**2;** the single-character attributes flag identifying the character with descenders. The semicolon (;) is the hexadecimal data terminator.

```
0;0;0;72;88;7;88;72;0;0;0;0;
```

the ASCII data generated from each column of the character layout in Figure 41.

**Example 3: Characters with Extenders**

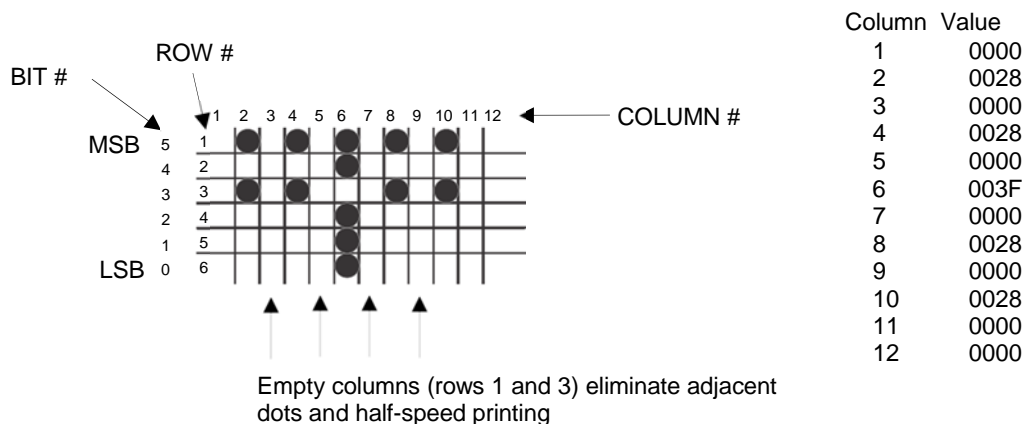

Selected Font and Pitch: HS 10 cpi.  
 HS with 10 cpi with extenders = 12 Columns x 6 bits per column (Table 84)

**Figure 42 Layout of a Character with Extenders**

The BASIC program to generate this character and a print sample are illustrated below.

**When using normal character sets:**

(For normal character set examples, refer to page 240.)

```
10 WIDTH "LPT1:", 255
20 LPRINT CHR$(27); "@";
30 LPRINT CHR$(27); "c201010E6; 0; 28; 0; 28; 0; 3F; 0; 28; 0; 28; 0; 0; ";
40 LPRINT CHR$(27); "V1E66E1010E";
50 LPRINT CHR$(27); "RX";
60 LPRINT CHR$(27); "X20";
70 LPRINT "BBBBB"
```

**When UTF-8 is enabled:**

```
10 WIDTH "LPT1:", 255
20 LPRINT CHR$(27); "@";
30 LPRINT CHR$(27); "c201010U6; 0; 28; 0; 28; 0; 3F; 0; 28; 0; 28; 0; 0; ";
40 LPRINT CHR$(27); "V1U66U1010U";
50 LPRINT CHR$(27); "RX";
60 LPRINT CHR$(27); "X20";
70 LPRINT "BBBBB"
```

TTTTT

The command for the character shown in Figure 42 is as follows:

**When using normal character sets:**

(For normal character set examples, refer to page 240.)

```
ESC c 201010E6; 0; 28; 0; 28; 0; 3F; 0; 28; 0; 28; 0; 0;
```

**When UTF-8 is enabled:**

```
ESC c 201010U6; 0; 28; 0; 28; 0; 3F; 0; 28; 0; 28; 0; 0;
```

where:

- ESC c** the control code header introducing the Download a character command.
- 20** the selected font and pitch code from Table 84 where code 20 represents HS10.
- 1010E** the address location in the Character Library (Appendix C) where the downloaded character will be sent. Address 1010 is an unused address. E is the decimal field terminator (required after each decimal field).
- 1010U** the address location in the Unicode chart where the downloaded character will be sent. The existing characters at 1010 will be replaced with the new character. U is the decimal field terminator (required after each decimal field).
- IMPORTANT** **If a downloaded character replaces an existing character in a font and pitch, that character will be changed in every character set or international language in which that existing character was used.**
- 6;** the single-character attributes flag identifying the character with extenders. The semicolon (;) is the hexadecimal data terminator.



0;28;0;28;0;3F;0;28;0;28;0;0;

the ASCII data generated from each column of the character layout in Figure 42.

**Example 4: Characters with Ascenders**

This character replaces the NLQ 10 capital A.

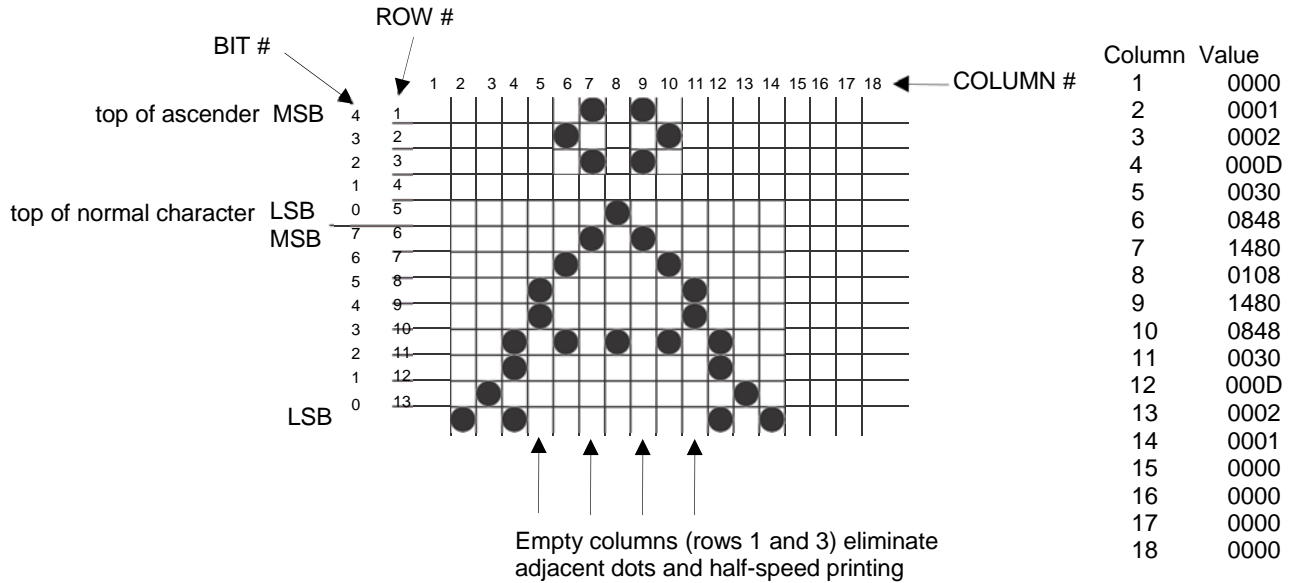

Selected Font and Pitch: NLQ 10 cpi.

NLQ with 10 cpi with ascenders = 18 Columns x 13 bits per column (Table 84)

**Figure 43 Layout of a Character with Ascenders**

The BASIC program to generate this character and a print sample are illustrated below.

**When using normal character sets:**

(For normal character set examples, refer to page 240.)

```
10 WIDTH "LPT1: ", 255
20 LPRINT CHR$(27); "@";
30 LPRINT CHR$(27); "c1065E8; 0; 1; 2; D; 30; 848; 1480; 108; 1480; 848;
30; D; 2; 1; 8; 0; 0; 0;
40 LPRINT CHR$(27); "X10";
50 LPRINT "AAAAA"
```

**When UTF-8 is enabled:**

```
10 WIDTH "LPT1: ", 255
20 LPRINT CHR$(27); "@";
30 LPRINT CHR$(27); "c1065U8; 0; 1; 2; D; 30; 848; 1480; 108; 1480; 848;
30; D; 2; 1; 8; 0; 0; 0;
40 LPRINT CHR$(27); "X10";
50 LPRINT "AAAAA"
```

AAAAA

The command for the character shown in Figure 43 is as follows:

**When using normal character sets:**

(For normal character set examples, refer to page 240.)

```
ESC c 1065E8;0;1;2;D;30;848;1480;108;1480;848;30;D;2;1;0;0;0;0;
```

**When UTF-8 is enabled:**

```
ESC c 1065U8;0;1;2;D;30;848;1480;108;1480;848;30;D;2;1;0;0;0;0;
```

where:

- ESC c** the control code header introducing the Download a character command.
- 10** the selected font and pitch code from Table 84 where code 10 represents NLQ 10.
- 65E** the address location in the Character Library (Appendix C) where the downloaded character will be sent. E is the decimal field terminator (required after each decimal field).
- 65U** the address location in the Unicode chart where the downloaded character will be sent. U is the decimal field terminator (required after each decimal field).

**IMPORTANT** If a downloaded character replaces an existing character in a font and pitch, that character will be changed in every character set or international language in which that existing character was used.

**8;** the single-character attributes flag identifying the character with ascenders. The semicolon (;) is the hexadecimal data terminator.

**0;1;2;D;30;848;1480;108;1480;848;30;D;2;1;0;0;0;0;**

the ASCII data generated from each column of the character layout in Figure 43.

### Downloaded Fonts and Character Sets

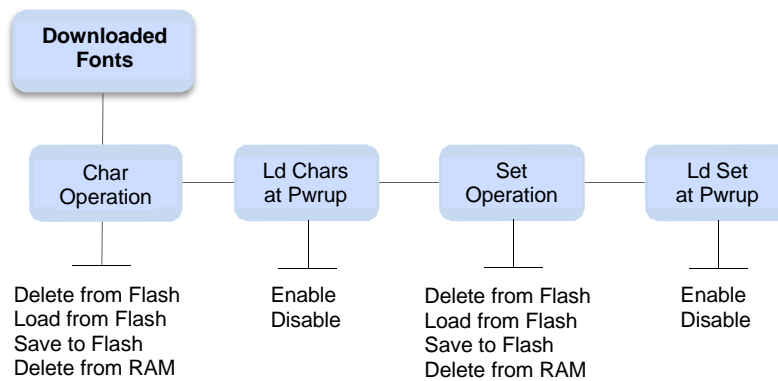

**Figure 44 Menu Structure for Downloaded Fonts and Character Sets**

The Downloaded fonts menu is located under LinePrinter+ in a menu called Downloaded Fonts. The structure can be seen in Figure 44. Char Operation allows you to save the characters which are currently in RAM into flash. Any characters which are in flash will be deleted. The submenu also allows you to delete characters from flash, load the characters from flash, or delete characters from RAM. If the characters are loaded from flash, all characters currently in RAM are deleted. These menus do not “star” when they are selected, they simply execute the function.

The downloaded characters can be deleted from RAM in the following ways: using the front panel menu option, performing a soft reset, or sending a printer reset that reloads the power-up configuration. Sending characters in the wrong format will also delete all characters in RAM.

When characters are sent to the printer they are stored in RAM and automatically used. To save the characters in RAM to the flash memory, the menu must be used. When the characters are stored, only the characters currently in memory will be stored. Characters which are currently in flash memory will be deleted. To add characters to those already stored in flash memory, the following sequence must be followed:

1. Load characters from flash.
2. Download more characters from the host.
3. Save the characters to flash from the menu.

If flash memory is full, or there are no file headers left to save the characters, the printer will not save the characters in flash. A message will be displayed on the front panel. The user must optimize the flash in order to save the characters.

When the Ld Chars at Pwrup menu is enabled, it causes the printer to load any downloaded characters from flash on power-up or during a soft reset. This option can be saved on a per configuration basis. When a configuration which has this option enabled is loaded on power-up, during a soft reset, or load configuration operation then the characters will be loaded from flash. This will delete any characters currently in RAM. The characters in RAM can be deleted through the menu also.

A downloaded character set can be saved, loaded, or deleted from flash memory, or RAM using the Set Operation menu. It can also be loaded from flash at power-up or soft reset on a per configuration basis by enabling the Ld Set at Pwrup. For the loaded table to take effect the command <SFCC>Rx must be issued from the host.

## Download a Character Set Overlay

<b>ASCII Code</b>	SFCC V
<b>Hex Code</b>	SFCC 56
<b>Dec Code</b>	SFCC 86
<b>Purpose</b>	To define and download a character set overlay (substitution table) that can be placed within the 224 printable symbol code points (0x20 to 0xFF).
<b>Expression</b>	SFCC V is followed by ASCII characters: {QQQ}E{AAA}E{SSSS}E (Each parameter is separated by paired brace symbols for clarity in distinguishing parameters. Do not put the braces in the command sequence). Multiple sets of characters can follow one SFCC V.
<b>where</b>	E is the terminator following each numeric field for overlay using the Printronix number. {QQQ} represents a decimal value between 0 and 255, which identifies the number of entries in the substitution table. No leading zeros are required for entries of one and two digits. Each entry consists of:  {AAA} representing the decimal value between 0 and 255. These digits identify the address code that causes the substituted character to print. No leading zeros are required for entries of one and two digits.

{SSSS} representing the decimal value between 0 and 65535. These digits identify the symbol code point in the Multinational Character Set. No leading zeros are required for entries containing less than five digits. Any symbol in the Character Library in Appendix C can be substituted into any printable symbol code point.

**Comment**

The character set overlay is valid only for the current base character set. You must reload the character set overlay after a new character set is selected. After switching from NON-OCR typeface to OCR typeface or vice versa, you must reload the character set overlay to print the correct characters. Any symbol in the Character Library in Appendix C can be substituted into any printable symbol code point.

If {AAA} is the same value as a control character, the control character takes precedence, and printing of that value does not occur. If the Space (hex 20) is substituted, unexpected results may occur, including decreased print speed.

Once defined and downloaded by this control code, the table created by this control code can be saved into the printer power-up configuration and selected from the host interface or the control panel. The table does not take effect until requested; to activate the table from the host, use the sequence SFCC RX. The substitution table starts with the currently active character set and overlays characters on top of it. The table is deactivated by the command sequence SFCC R0 or when the character set is changed. When the table is selected via the control panel, the message "DOWNLOADED" displays.

**Example**

The following sample illustrates Downloading a Character Set Overlay using a Printronix number.

```
Control code SOH V 2E65E224E66E225E
Downloads a language that replaces
A with Alpha and B with Beta
Control code SOH RX activates the
downloaded language.
```

```
A B
α β
```

SOHV{2}E{65}E{224}E{66}E{225}E

- SOH V Special Function Control Code (SFCC) header introducing the Download a Character Set Overlay command.
- {2} The quantity of entries (characters) in the substitution table (in this example, the letters A and B).
- {E} The numeric field terminator for overlay using a Printronix number (required after each numeric field).
- {65} The (decimal) address code for the first character in the current character set that causes the substituted character to be printed (uppercase A/alpha).
- {224} The (decimal) symbol point in the Character Library in Appendix C representing the substituted character selected (lowercase a/alpha).
- {66} The (decimal) address code for the second character in the current character set that causes the substituted character to be printed (uppercase B/beta).
- {225} The (decimal) symbol point in the Character Library (Appendix C) representing the substituted character selected (lowercase b/beta).

**NOTE:** Not all fonts have all characters. Characters are included only to support predefined character sets. In general, DP 10 and NLQ 10 have the widest coverage, High Speed and OCR fonts have the least coverage.

The SFCC V and SFCC RX commands are not supported with the U- terminator when UTF-8 is enabled. See Table 85 below for details.

**Table 85 E and U Terminator Support**

	<b>E Terminator</b>	<b>U Terminator</b>
SFCC V	supported	not supported
SFCC RX	supported	not supported



# 11 *Indian Font Printing*

The Indian language can be printed on Indian language printers with LP+ Emulations (P-Series, Serial Matrix, Proprinter III XL, and Epson FX). However, when used for Indian character printing, the following commands in LP+ will not produce Printronix printer behavior:

- Backspace
- Delete
- Over scoring
- Auto LF will not work for Data Page selection
- Set Intercharacter spacing





# A ASCII Character Set

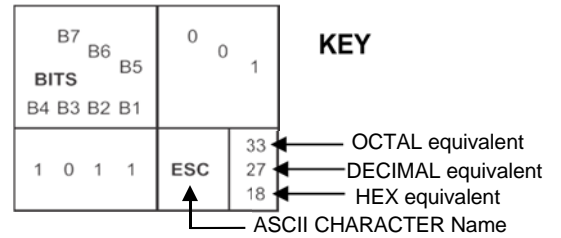

BITS B7 B6 B5 B4 B3 B2 B1	ROW	0 0 0		0 0 1		0 1 0		0 1 1		1 0 0		1 0 1		1 1 0		1 1 1	
		COLUMN 0		1		2		3		4		5		6		7	
0 0 0 0	0	NUL	0 0 0	DLE	20 16 10	SP	40 32 20	0	60 48 30	@	100 64 40	P	120 80 50	\	140 96 60	p	160 112 70
0 0 0 1	1	SOH	1 1 1	DC1 (XON)	21 17 11	!	41 33 21	1	61 49 31	A	101 65 41	Q	121 81 51	a	141 97 61	q	161 113 71
0 0 1 0	2	STX	2 2 2	DC2	22 18 12	"	42 34 22	2	62 50 32	B	102 66 42	R	122 82 52	b	142 98 62	r	162 114 72
0 0 1 1	3	ETX	3 3 3	DC3 (XOFF)	23 19 13	#	43 35 23	3	63 51 33	C	103 67 43	S	123 83 53	c	143 99 63	s	163 115 73
0 1 0 0	4	EOT	4 4 4	DC4	24 20 14	\$	44 36 24	4	64 52 34	D	104 68 44	T	124 84 54	d	144 100 64	t	164 116 74
0 1 0 1	5	ENQ	5 5 5	NAK	25 21 15	%	45 37 25	5	65 53 35	E	105 69 45	U	125 85 55	e	145 101 65	u	165 117 75
0 1 1 0	6	ACK	6 6 6	SYN	26 22 16	&	46 38 26	6	66 54 36	F	106 70 46	V	126 86 56	f	146 102 66	v	166 118 76
0 1 1 1	7	BEL	7 7 7	ETB	27 23 17	'	47 39 27	7	67 55 37	G	107 71 47	W	127 87 57	g	147 103 67	w	167 119 77
1 0 0 0	8	BS	10 8 8	CAN	30 24 18	(	50 40 28	8	70 56 38	H	110 72 48	X	130 88 58	h	150 104 68	x	170 120 78
1 0 0 1	9	HT	11 9 9	EM	31 25 19	)	51 41 29	9	71 57 39	I	111 73 49	Y	131 89 59	i	151 105 69	y	171 121 79
1 0 1 0	10	LF	12 10 0A	SUB	32 26 1A	*	52 42 2A	:	72 58 3A	J	112 74 4A	Z	132 90 5A	j	152 106 6A	z	172 122 7A
1 0 1 1	11	VT	13 11 0B	ESC	33 27 1B	+	53 43 2B	;	73 59 3B	K	113 75 4B	[	133 91 5B	k	153 107 6B	{	173 123 7B
1 1 0 0	12	FF	14 12 0C	FS	34 28 1C	,	54 44 2C	<	74 60 3C	L	114 76 4C	\	134 92 5C	l	154 108 6C		174 124 7C
1 1 0 1	13	CR	15 13 0D	GS	35 29 1D	-	55 45 2D	=	75 61 3D	M	115 77 4D	]	135 93 5D	m	155 109 6D	}	175 125 7D
1 1 1 0	14	SO	16 14 0E	RS	36 30 1E	.	56 46 2E	>	76 62 3E	N	116 78 4E	^	136 94 5E	n	156 110 6E	~	176 126 7E
1 1 1 1	15	SI	17 15 0F	US	37 31 1F	/	57 47 2F	?	77 63 3F	O	117 79 4F	_	137 95 5F	o	157 111 6F	DEL	177 127 7F



# B *PTX\_SETUP* Commands

## Overview

The PTX\_SETUP commands are a superset of commands which allows the printer to perform several tasks by parsing commands either stored in flash memory or sent to the printer by the host. Commands range from re-routing debug statements to downloading complete printer configurations.

## The PTX\_SETUP Commands

Notes on using PTX\_SETUP

1. PTX\_SETUP commands are not emulation specific. In a system with an IGP, the IGP level emulation will process the PTX\_SETUP commands. In a system without an IGP, the PTX\_SETUP commands will be processed by the base emulation.
2. Since there is no disk on a flash-based printer, DISK\_IO commands are now called FILE\_IO. However, for backwards compatibility DISK\_IO and FILE\_IO are synonymous.
3. The PTX\_SETUP command set is case sensitive; all PTX\_SETUP commands are in upper case characters only.
4. The white space separating commands may be any number of spaces and tabs. This allows a PTX\_SETUP file to be formatted for easier readability.
5. The PTX\_SETUP and PTX\_END command should be followed by a new line character.
6. Any unknown command will terminate the PTX\_SETUP processing. The offending command will be the first line of printed text.
7. Although the original implementation of PTX\_SETUP allowed for only a single parameter, separated from the sub-command by a single semicolon (;) character, the new PTX\_SETUP command set allows for multiple parameters separated by commas, semicolons, spaces or tabs.

## General Commands

The original PTX\_SETUP commands were implemented on the disk-based legacy laser printers; however, many commands are general and are also supported on line matrix printers. This section describes the existing commands which work across all platforms, and provides a general description of how commands are formed.

Each emulation has modes in which the PTX\_SETUP commands could get missed. For this reason, it is highly recommended that all PTX\_SETUP commands be placed between print jobs, rather than attempting to imbed them within jobs.

PTX\_SETUP commands have the following format:

**(SFCC)PTX\_SETUP**

*Command–Sub Command;Value*

**PTX\_END**

For example, if the SFCC assigned to the emulation you are using is the exclamation point (!, hex 5E), and you wanted to load configuration number 4 and capture all incoming data to a file named "BIN", you would use the following command:

```
!PTX_SETUP
CONFIG-LOAD;4 FILE_IO-CAPTURE;BIN
PTX_END
```

Table 86 lists all the command, sub-command, and parameter combinations and gives a brief description of the command. This section documents the existence of PTX\_SETUP commands which work across all platforms. The following sections document commands which are specific to line matrix.

**NOTE:** When a file system error occurs, a message will be displayed on the front panel indicating the error, and the action needed to take to correct the error.

**Table 86 PTX\_SETUP Commands (Non-Platform Specific)**

Command	Sub-Command	Parameter	Description
CONFIG	LOAD	<i>Cfg</i>	<i>Cfg</i> can be 0-8. The PTX_SETUP will load configuration <i>Cfg</i> . If configuration <i>Cfg</i> was not previously saved, the operator panel will display an error message and the current configuration will be kept.
	SAVE	<i>Cfg</i>	<i>Cfg</i> must be 1-8. This command will save the current configuration as configuration <i>Cfg</i> . If <i>Cfg</i> is not in the range of 1-8, the command is ignored.
	SETMENU	<i>Value;Menu_tag</i>	<i>Menu_tag</i> is the name of the menu as defined in the menu file. <i>Value</i> is the value to which the menu is to be set.
	POWERUP	<i>Cfg</i>	Sets the power-up configuration to <i>Cfg</i> and loads Configuration <i>Cfg</i> . <i>Cfg</i> can be any value from 0-8, where 0 is the factory default.
	PRINT	<i>Cfg</i>	Print Configuration <i>Cfg</i> . <i>Cfg</i> can be a number 1-8, or one of four pre-defined configurations. The four non-numeric configurations are requested using the first character for the CURRENT, FACTORY, POWERUP, or ALL configuration(s).

**Table 86 PTX\_SETUP Commands (Non-Platform Specific)**

Command	Sub-Command	Parameter	Description
CONFIG	DELETE	<i>Cfg</i>	Deletes Configuration number <i>Cfg</i> . <i>Cfg</i> must be in the range of 1-8.
	UPLOAD	<i>Port;Cfg</i>	This command uploads the configuration stored in location <i>Cfg</i> to the port specified by <i>Port</i> . <i>Port</i> must either be 1284 or SERIAL. <i>Cfg</i> may be 1-8 or ALL.
	DOWNLOAD	<i>Cfg</i>	This command saves the configuration data that follows as configuration <i>Cfg</i> . <i>Cfg</i> must be 1-8 or END.
	OVERLAY	<i>Cfg</i>	This command overlays the configuration data that follows on existing configuration <i>Cfg</i> . <i>Cfg</i> must be 1-8 (or END). If <i>Cfg</i> does not exist then command is treated the same as DOWNLOAD.
	RESET		Reboots the printer.
	GET_NAMES	<i>"Port"</i>	This command uploads the names of the configurations to the port specified by <i>Port</i> . <i>Port</i> must either be "1284" or "SERIAL".
	SET_NAME	<i>Cfg</i>	This command downloads a name for the configuration specified by <i>Cfg</i> . <i>Cfg</i> must be 1-8.
	CLEAR_NAMES		This command resets all of the configuration names to their default values.
	MPI_SELECT	<i>MPI</i>	This command selects the active Management Protocol Interface (MPI). Currently there are two selections "UCP" and "PXML".

**Table 86 PTX\_SETUP Commands (Non-Platform Specific)**

Command	Sub-Command	Parameter	Description
CONFIG	PNE_PORT	<i>Port</i>	This command selects the port that the PNE will use to communicate to the printer. The valid ports are: <ul style="list-style-type: none"> <li>• DISABLE</li> <li>• ETHERNET</li> <li>• USB</li> </ul> <b>NOTE:</b> If ETHERNET is selected but not enabled, the selection will revert to DISABLE.
	PANEL	LOCK	This command locks the operator out of the printer's configuration menu.
		UNLOCK	This command unlocks the printer's configuration menu and allows the operator access to the menus. By default, the menu is unlocked.
	PNE_PORT_NUM	<i>Port Number</i>	This command sets the Port Number the PNE uses to communicate to the printer if the PNE Port was set to Ethernet. This command causes the printer to automatically reboot.
PXML_PORT_NUM	<i>Port Number</i>	This command sets the Port Number the PXML and UCP will use to communicate to the printer if the PXML Port is set to Ethernet. This command causes the printer to automatically reboot.	
LP MODE	n/a	Protocol	<i>Protocol</i> must be 0-4. This command resets the software protocol, and is selected as follows: <ul style="list-style-type: none"> <li>0 - P-Series</li> <li>1 - P-Series XQ</li> <li>2 - Serial Matrix</li> <li>3 - Proprinter III XL</li> <li>4 - Epson FX-1050</li> </ul>
FILE_IO (DISK_IO)	CAPTURE	Filename	Captures all incoming data into a file named <i>Filename</i> . Receipt of a FILE_IO-CAPTURE command without the <i>Filename</i> parameter will force the file data to be written to flash, and will end the file capture.

**Table 86 PTX\_SETUP Commands (Non-Platform Specific)**

Command	Sub-Command	Parameter	Description
FILE_IO (DISK_IO)	DRIVE	Letter	This command is parsed for backwards compatibility. However, since the flash file system is a single device, the drive letter will be ignored.
	PROPS	File;Prop	The PROPS command will set the file properties of a given file. The file properties are a four letter, case sensitive file descriptor. The properties field can be used to ensure that a file is used for its intended purpose. Once properties have been associated with a file, they cannot be changed.
	DEL	Filename	The DEL command will mark a file as deleted. The space the file occupied will be freed the next time the printer is powered up.
	RUNFILE	File;Prop	The RUNFILE command will open the file named <i>File</i> for printing. After the PTX_END command is processed, the contents of <i>File</i> will get printed before any more data is read from the host. If the <i>Prop</i> field is present, RUNFILE will verify that <i>Prop</i> matches the saved file properties. Any mismatch will cause the command to be ignored.
	UPLOAD	File;Port	Reads the file named <i>File</i> out of the flash file system and sends it to a host computer via the <i>Port</i> I/O port. <i>Port</i> is either 1284 (for reverse nibble or byte mode transfer using the parallel port), or SERIAL. NOTE: if the Ethernet option is installed, 1284 is used to upload across the network.
	MAXSIZE	Kb	For backwards compatibility.
	MINSIZE	Kb	For backwards compatibility.
	OPTIMIZE	(none)	Causes the printer to optimize the Flash File System. The printer automatically reboots during this process.
PTX_END	(none)	(none)	Exits the PTX_SETUP.

## Summary of the CONFIG Command

The UPLOAD and DOWNLOAD command can be used for uploading and downloading complete printer configurations. If a customer needs to configure 50 printers identically, the customer needs only configure one printer and UPLOAD the configurations. The UPLOADED configurations may then be DOWNLOADED to other printers eliminating the necessity for the operator to configure each printer manually.

The UPLOAD command will always place a header and a footer into the uploaded data. This header will be the DOWNLOAD command followed by the configuration number. The footer will be the DOWNLOAD END command. The operator should be aware that the UPLOAD and DOWNLOAD commands use a secondary copy of the menu structure which does not affect the printer's active configuration. This allows the UPLOAD and DOWNLOAD commands to operate without affecting the printer's current configuration. If the operator intends to use one of the DOWNLOADED configurations, the operator should reboot the printer to ensure proper operation. This can be accomplished by adding the RESET command as the last command in your setup file. This is necessary because the printer caches the active configuration. Rebooting the printer ensures that the desired configuration is correctly read from Non-Volatile RAM.

**NOTE:** While an upload or download is in progress, the Front Panel will be unavailable.

The Configuration Save and Delete commands from the front panel can be blocked by using the Protect Configurations feature. This is intended to prevent someone from inadvertently reconfiguring a printer. The PTX\_SETUP commands, however, will override the protect configurations feature. All PTX\_SETUP commands will be honored regardless of the value of the Protect Configurations feature.

## Operation of the FILE\_IO Command

When a file is opened for writing with the FILE\_IO CAPTURE *filename* command, the system will allocate RAM for file control blocks and 1 Kbyte for data. If the file already exists on the Flash File System and the Overwrite Enable feature in the Flash File System menu is set to disable, a warning will be displayed on the front panel. After clearing the warning, the file data will be printed. To overwrite the existing file, set the Overwrite Files option to enable.

Due to the nature of writing to flash, any data intended to be stored permanently in flash must first be copied into RAM. As a result, the ability to manipulate files in the Flash File System is dependent upon the printer having sufficient RAM. None of the captured file data will be committed to flash until the entire file is loaded. The PTX\_SETUP parser will interpret the command "FILE\_IO-CAPTURE<lf>" as an end of file marker. Receipt of the command will cause all file data to be written to flash. The file system allocates RAM for temporary data storage in 1 Kbyte blocks. If at any time during the file download the printer runs out of RAM, a warning will be displayed on the front panel and as much of the file as possible will be saved in flash.

Three things can limit the ability to save a file: insufficient RAM, insufficient Flash, and lack of empty file system entries. Flash can only be written once before it needs to be "optimized". As a result, the maximum file size is limited to the largest unwritten block of Flash. If any of these problems occur, the printer will display an error message and will attempt to provide the operator with a description of what steps to take to correct the error. Normally, the solution will involve optimizing the Flash File System. This can be accomplished by selecting the Optimize & Reboot function in the Flash File System menu under the ADVANCED USER menu, "Main File System."

**NOTE:** After selecting the Optimize & Reboot function, do not shut off the printer's power until after the printer returns to the power-on state. Loss of power during the optimize process may corrupt the printer's program. If this occurs, first attempt to repeat the downloading process. If that fails, contact an authorized service representative.

## Line Matrix Commands

Table 87 lists PTX\_SETUP commands which apply to line matrix printers only.



**Table 87 Line Matrix PTX\_SETUP Commands**

<b>Command</b>	<b>Sub-Command</b>	<b>Parameter</b>	<b>Description</b>
ENGINE	EJECT		Performs a page eject.



# C *Character Library*

In the P-Series and Serial Matrix emulations, character set overlays (substitution tables) can be downloaded (SFCC V) and stored until needed. Using the Downloading Characters and Character Sets feature allows you to define and download a character set overlay which can be placed within the 224 printable symbol code points. The Download a Character command allows characters to be defined and stored in non-volatile memory (See Chapter 4).

The character library on the following pages identifies each character's location in printer memory by its decimal address value.

Address Table in Decimal

	0	1	2	3	4	5	6	7	8	9
000_	—	ı	ı	ı	ı	ı	ı	ı	ı	ı
001_	ˆ	ˆ	ˆ	ˆ	ˆ	ˆ	ˆ	ˆ	ˆ	ˆ
002_	ı	ı	ı	ı	ı	ı	ı	ı	ı	ı
003_	x	ı	ı	ı	ı	ı	ı	ı	ı	ı
004_	(	)	*	+	,	-	.	/	0	1
005_	2	3	4	5	6	7	8	9	:	;
006_	<	=	>	?	@	A	B	C	D	E
007_	F	G	H	I	J	K	L	M	N	O
008_	P	Q	R	S	T	U	V	W	X	Y
009_	Z	[	\	]	^	_	`	a	b	c
010_	d	e	f	g	h	i	j	k	l	m
011_	n	o	p	q	r	s	t	u	v	w
012_	x	y	z	{		}	~	ı	ı	ı
013_	é	ä	ä	à	à	ç	ē	ē	è	ı
014_	ı	ı	ˆ	ˆ	é	æ	æ	ö	ö	ö
015_	ü	ü	ü	ö	ü	£	¥	₹	₹	₹
016_	á	ı	ó	ó	ñ	ñ	ä	ä	ı	ı
017_	ı	ı	ı	ı	ı	ı	ı	ı	ı	ı
018_	ı	ı	ı	ı	ı	ı	ı	ı	ı	ı
019_	ı	ı	ı	ı	ı	ı	ı	ı	ı	ı
020_	ı	ı	ı	ı	ı	ı	ı	ı	ı	ı

	0	1	2	3	4	5	6	7	8	9
021_	ı	ı	ı	ı	ı	ı	ı	ı	ı	ı
022_	ı	ı	ı	ı	ı	ı	ı	ı	ı	ı
023_	ı	ı	ı	ı	ı	ı	ı	ı	ı	ı
024_	ı	ı	ı	ı	ı	ı	ı	ı	ı	ı
025_	ı	ı	ı	ı	ı	ı	ı	ı	ı	ı
026_	ı	ı	ı	ı	ı	ı	ı	ı	ı	ı
027_	ı	ı	ı	ı	ı	ı	ı	ı	ı	ı
028_	ı	ı	ı	ı	ı	ı	ı	ı	ı	ı
029_	ı	ı	ı	ı	ı	ı	ı	ı	ı	ı
030_	ı	ı	ı	ı	ı	ı	ı	ı	ı	ı
031_	ı	ı	ı	ı	ı	ı	ı	ı	ı	ı
032_	ı	ı	ı	ı	ı	ı	ı	ı	ı	ı
033_	ı	ı	ı	ı	ı	ı	ı	ı	ı	ı
034_	ı	ı	ı	ı	ı	ı	ı	ı	ı	ı
035_	ı	ı	ı	ı	ı	ı	ı	ı	ı	ı
036_	ı	ı	ı	ı	ı	ı	ı	ı	ı	ı
037_	ı	ı	ı	ı	ı	ı	ı	ı	ı	ı
038_	ı	ı	ı	ı	ı	ı	ı	ı	ı	ı
039_	ı	ı	ı	ı	ı	ı	ı	ı	ı	ı
040_	ı	ı	ı	ı	ı	ı	ı	ı	ı	ı

Address Table in Decimal

	0	1	2	3	4	5	6	7	8	9		0	1	2	3	4	5	6	7	8	9	
041_											061_	l	l	l	l	l	l	l	l	l	l	l
042_											062_	l	l	l	l	l	l	l	l	l	l	l
043_											063_	l	l	l	l	l	l	l	l	l	l	l
044_											064_	l	l	l	l	l	l	l	l	l	l	l
045_											065_	l	l	l	l	l	l	l	l	l	l	l
046_	'	"	'	"	'	"	'	"			066_	l	l	l	l	l	l	l	l	l	l	l
047_	⌘	■	ÿ	è	î	û	¼	¾			067_	l	l	l	l	l	l	l	l	l	l	l
048_	™	=	'					-			068_	l	l	l	l	l	l	l	l	l	l	l
049_		↑	↓	→	̄	̅	̆	̇			069_	l	l	l	l	l	l	l	l	l	l	l
050_	̈	̉	̊	̋	̌	̍	̎	̏			070_	l	l	l	l	l	l	l	l	l	l	l
051_	²	³	£	J	A	B	C	D			071_	l	l	l	l	l	l	l	l	l	l	l
052_	G	H	I	J	K	L	M	N			072_											
053_	Q	R	S	T	U	V	W	X			073_											
054_	1	2	3	4	5	6	8	9			074_											
055_	t	l	≤	≥	†	z	z	z			075_											
056_	z	l	≤	≥	†	z	z	z			076_											
057_	l	é	è	É	È	Đ	Ń	Ň			077_											
058_	ú	û	ı	ı	ı	ı	ı	ı			078_											
059_	8	ñ	ñ	ó	ı	ú	ú	ı			079_											
060_	r	-	ı	ı	ı	ı	ı	ı			080_											

Address Table in Decimal

	0	1	2	3	4	5	6	7	8	9		0	1	2	3	4	5	6	7	8	9	
081_											101_	พ	ฟ	ภ	ม	ย	ร	ฤ	ล	ภ	ว	
082_											102_	ศ	ช	ศ	ท	พ	อ	ฉ	ช	ฉ	จ	
083_											103_	า	า	า	า	า	า	า	า	า	า	า
084_											104_	า	า	า	า	า	า	า	า	า	า	า
085_											105_	.	๓	๐	๑	๒	๓	๔	๕	๖	๗	
086_											106_	๘	๙	๐	๑	๒	๓	๔	๕	๖	๗	
087_											107_											
088_											108_											
089_											109_										ā	ā
090_											110_	б	б	с	с	е	е	ē	ē	ē	ē	
091_											111_	é	é	ê	ê	é	é	é	é	é	é	
092_											112_	ı	ı	ı	ı	ı	ı	ı	ı	ı	ı	
093_											113_	Ń	Ń	ō	ō	Ń	Ń	Ń	Ń	Ń	Ń	
094_											114_	Ť	Ť	Ť	Ť	Ť	Ť	Ť	Ť	Ť	Ť	
095_	ı	ı	ı	ı	ı	ı	ı	ı	ı	ı	115_	Ÿ	Ÿ	Ÿ	Ÿ	Ÿ	Ÿ	Ÿ	Ÿ	Ÿ	Ÿ	
096_	ı	ı	ı	ı	ı	ı	ı	ı	ı	ı	116_	Ź	Ź	Ź	Ź	Ź	Ź	Ź	Ź	Ź	Ź	
097_	ı	ı	ı	ı	ı	ı	ı	ı	ı	ı	117_	ı	ı	ı	ı	ı	ı	ı	ı	ı	ı	
098_	ı	ı	ı	ı	ı	ı	ı	ı	ı	ı	118_	ı	ı	ı	ı	ı	ı	ı	ı	ı	ı	
099_	ı	ı	ı	ı	ı	ı	ı	ı	ı	ı	119_	ı	ı	ı	ı	ı	ı	ı	ı	ı	ı	
100_	ı	ı	ı	ı	ı	ı	ı	ı	ı	ı	120_	ı	ı	ı	ı	ı	ı	ı	ı	ı	ı	

Address Table in Decimal

	0	1	2	3	4	5	6	7	8	9
121_	آ	آ	ؤ	ل	ا	ب	ت	ج	خ	
122_	ع	غ	هـ	لا	ي	ي	+	ك	٧	
123_	ل	لا	لا	ل	لا	ب	ا	ح	ع	
124_	ع	ف	غ	ش	ص	هـ	ب	ظ	ظ	
125_	.	ا	ة	خ	ز	٢	٦	و	ث	
126_	هـ	ي	ن	د	ك	س	ص	ظ	ض	
127_	يا	خ	ش	ع	غ	هـ	٢	”	،	/
128_	١	/	ا	ك	ش	٦	٥	ل	ع	ل
129_	٦	٧	٨	٩	١٠	١١	١٢	١٣	١٤	١٥
130_	+	ل	ظ	ب	ب	ج	د	ز	ك	ك
131_	ك	٢	٥	٣	٤	%	٦	ر	ط	
032_										
133_										
134_										
135_										
136_										
137_							*			
138_										
139_										
140_	٧	٥		٢	٥	٧	٧			
141_										
142_										
143_										
144_										
145_										
146_										
147_										
148_										
149_										





# D *Glossary*

## A

A to D	Analog to Digital.
ACIA	<i>Acronym for Asynchronous Communication Interface Adapter.</i>
ACK	Acknowledge character. A transmission control character transmitted by the printer as an affirmative response to an enquiry from the host.
active column	The horizontal location on the paper where the next character will print.
active line	The vertical location on the paper where the next character will print.
active position	The position on the paper where the next character will print. The intersection of the active column and the active line.
ASCII	<i>Abbrev. for American Standard Code for Information Interchange.</i> A standard character encoding scheme introduced in 1963 and used widely on many computers and printers. It is a 7-bit code with 128 different bit patterns. There is no parity recommendation.
attributes, print	Operations performed on text that alter its appearance but do not change the font. Examples: underlining, superscripting, bold, etc.

## B

bar code	A printed code consisting of parallel bars of varied width and spacing and designed to be read by a one-dimensional scanning device.
baud	A unit of speed that measures the rate at which information is transferred. Baud rate is the reciprocal of the length in seconds of the shortest pulse used to carry data. For example, a system in which the shortest pulse is 1/1200 second operates at 1200 baud. On RS-232 serial lines, the baud rate equals the data flow rate in bits per second (bps). To communicate properly, a printer must be configured to operate at the same baud rate as its host computer.

bit	<i>Contraction of binary digit.</i> A digit in the binary number system, represented by a 0 or a 1. A bit is the smallest unit of storage in a digital computer, where 0 and 1 are represented by different voltages. Groups of bits form other units of storage called nibbles, bytes, and words.
bold	A print attribute specifying text of a heavy line thickness. <i>See also</i> character weight.
Boot-up	The start-up procedure which causes a computer operating system to be loaded into main memory.
buffer	A reserved area in memory that data is written to and read from during data transfers.
bus	A circuit for the transfer of data or electrical signals between two devices.
byte	A group of consecutive bits forming a unit of storage in a digital computer and used to represent one alphanumeric character. A byte usually consists of 8 bits, but may contain more or fewer bits, depending on the computer or protocol.

## C

character cell	The invisible rectangular space occupied by a character, including the white space around the character. The height of a cell remains constant even with changes in the current line spacing, and the width is equal to the current character spacing. Used as a unit of spacing.
character proportion	The ratio of character height to character width. <i>See also</i> compressed <i>and</i> expanded.
character set	A set of codes, each of which represents a control or printable character, including symbols, punctuation, numbers, diacritical markings, and alphabet characters. Each character is assigned a unique address in memory.
character weight	The degree of lightness and thickness of printed text. For example: "Bold" refers to a heavy or thick character weight. "Medium," "normal," or "book weight" refer to the character weight used in this sentence.
checksum	A value used to verify microcode correctness.
Code V	An optional QMS <sup>®</sup> emulation which allows you to create and store forms: generate logos, bar codes, and expanded characters; create other graphics, and merge graphics with alphanumeric data as a document is printed.
command	An operating instruction (e.g., form feed, or FF) sent from a computer to the printer. Also called a control code or non-printable character. Commands are opposed to data, which is printed.

command delimiter	An ASCII character used to begin a command string (same as SFCC). Commonly used command delimiters are ESC (1B hex) and SOH (01 hex).
command sequence	Two or more bytes that instruct the printer to perform a special function. The first character in the sequence is a special function control character (SFCC). This character alerts the printer that the string which follows is a command sequence, not a character or graphic code. <i>See also</i> escape sequence, SFCC, SSCC.
compatibility	The ability of one printer to accept and properly process commands meant for a different printer. <i>See also</i> emulation <i>and</i> protocol.
compressed	Refers to a typeface with a font width approximately 60% smaller than normal. Character height is not changed.
configuration	Refers to the operating properties that define how the printer responds to signals and commands received from the host computer at the printer interface. These properties are called configuration parameters and are set to match the operating characteristics of the host computer system.
controller	An independent logic unit in a data processing system that controls data paths between one or more units of peripheral equipment.
cpi	<i>Abbrev. for</i> characters per inch. A measurement of monospaced fonts indicating the horizontal character density. For example, 10 cpi means 10 characters can be printed in one horizontal inch. <i>See also</i> pitch.
cps	<i>Abbrev. for</i> characters per second. A measurement of the print speed of a serial (character) printer.
CPU	Central Processing Unit.
CR	Carriage Return.
CTS	Clear To Send. Status signal to the printer indicating the host is ready to receive data/status signals from the printer.
CVFU	<i>Abbrev. for</i> Centronics direct access Vertical Format Unit.

## D

data bits	Binary information sent to the printer; a character set grouping containing letters, digits, and punctuation marks to be printed, or control codes to move paper, format text and graphics, and position the text and graphics on the page.
DAVFU	<i>Abbrev. for</i> Direct Access Vertical Format Unit. Also known as NVFU. <i>See also</i> NVFU.
DC	Data Controller.
DCD	Data Carrier Detect. Status signal to the printer. The ON condition is required for the printer to receive data.

decipoint	One tenth of a point. A unit of length equal to 1/720 inch. <i>See also</i> point.
default	A value, parameter, attribute, or option assigned by a program or system if another is not specified by the user.
descender	The portion of a printed, lowercase character that appears below the base line. For example, “g”, “j”, “p”, “q”, and “y” all are characters with lowercase descenders.
diagnostic	Pertains to the detection and isolation of printer malfunctions or mistakes.
DIP	<i>Acronym for Dual In-line Package.</i> A method of packaging semiconductor components in rectangular cases with parallel rows of electrical contacts.
DIP switch	A DIP equipped with switches. A typical DIP switch has from four to ten individual switches mounted in its package. The individual switches are typically toggle, rocker, or slide switches.
disable	To deactivate or set to OFF.
diskette	A thin, flexible magnetic disk containing software such as test and diagnostic programs, initialization files, and all font specifications for the printer.
DP	<i>Abbrev. for Data Processing.</i> ( <i>See also</i> HS or draft).
draft	A limited dot font used for rough copy. Low print quality but fast printing speed.
DRAM	Dynamic Random Access Memory.
DSR	Data Set Ready. Status signal to the printer indicating the host is in a ready condition.
DTR	Data Terminal Ready. Control signal from the printer indicating it is in a ready condition.
DVFU	<i>Abbrev. for Dataproducts direct access Vertical Format Unit.</i>

## E

EBCDIC	Extended Binary Coded Data for Information Communication.
EC	Engine Controller.
ECMA	European Computer Manufacturers Association.
EEPROM	Electrically Erasable Programmable Read Only Memory.
EIA/TIA	Electronic Industries Association/Telecommunications Industry Association
Elite	A name indicating a monospaced font with a pitch of 12 cpi (and usually 10 points in height).
em	A unit of measure in typesetting: the width of a piece of type about as wide as it is tall. (Derived from uppercase M, usually the widest character in a set.)

emulation	Refers to the ability of a printer to execute the commands of another printer protocol. When used as a proper noun (e.g., Proprinter III XL Emulation), it means printer protocol. See <i>also</i> compatibility and protocol.
en	A unit of measure in typesetting equal to half the width of an em.
enable	To activate, make true (1), or set to on.
escape sequence	A command sequence in which the first byte is always the ASCII ESC character. Same as “escape code.” See <i>also</i> command sequence, SFCC, SSCC.
ETX	End of Text. A transmission control character sent from the host to the printer, indicating the end of transmission of a block of data.
EVFU	<i>Abbrev. for</i> Electronic Vertical Format Unit. Relates to the ability to slew (skip quickly a specified number of lines).
expanded	A font enhancement referring to larger-than-normal character width with no change in character height.

## F

false	Off or zero. <i>Compare</i> true.
family (or type)	A set of all variations and sizes of a type style.
FF	Form Feed.
FIFO	First In, First Out.
fixed-pitch fonts	See font, monospaced.
font	The complete set of a given size of type, including characters, symbols, figures, punctuation marks, ligatures, signs, and accents. To fully describe a font, you must specify seven characteristics: <ol style="list-style-type: none"> <li>1) typeface</li> <li>2) spacing (proportional or monospaced)</li> <li>3) type size (12 point, 14 point, etc.)</li> <li>4) scale factor (character height/width ratio)</li> <li>5) type style</li> <li>6) character weight</li> <li>7) character proportion (normal, condensed, expanded).</li> </ol>
font, landscape	A font printed parallel to the long edge of a page.
font, monospaced	Also called fixed-pitch fonts. Every character, regardless of horizontal size, occupies the same amount of font pattern space. All monospaced fonts use specific pitch size settings. Monospaced fonts are sometimes used when strict character alignment is desired (tables, charts, spreadsheets, etc.).
font name	See typeface.
font pattern	The matrix of pixels which represents a character, symbol, or image.

font, portrait	A font printed parallel to the short edge of a page.
font, proportional	A font in which the width of a character cell varies with the width of the character. For example, [i] takes less space to print than [m]. Using proportional fonts generally increases the readability of printed documents, giving text a typeset appearance.
font weight	The thickness of the lines making up a character. For example, "bold" and "light" are different font weights.
font width	The measurement of the width of a character cell in dots.

## H

hammer	The hammer spring with a hammer tip mounted onto it.
hammer spring	The flat piece of metal, made of spring steel, which supports and pushes the hammer tip.
hammer tip	The small, round point, located near the end of the hammer spring, which strikes the ribbon and leaves a dot on the paper.
hex codes	Based on a numeral system with a radix of 16.
hex dump	A hex dump is a translation of all host interface data to its hexadecimal equivalent. A hex dump is a printer self-test typically used to troubleshoot printer data reception problems.
host computer	The computer that stores, processes, and sends data to be printed, and which communicates directly with the printer. The term "host" indicates the controlling computer, since modern printers are themselves microprocessor-controlled computer systems.
HS	<i>Abbrev. for</i> High Speed or Draft Print characters.
HT	Horizontal Tab.
Hz	<i>Abbrev. for</i> Hertz. Cycles per second. Frequency.

## I

IEEE	Institute of Electrical and Electronic Engineers, Inc.
IGP	Intelligent Graphics Processor. An interface that converts graphics commands received from the host computer to binary plot data that is usable by the printer. The IGP is the board-installed Intelligent Graphics Processor. The IGP provides on-line forms, bar codes, and many alphanumeric text-generation capabilities.
initialization	A series of processes and self-tests to set power-up default conditions and parameters.
interface	The hardware components used to link two devices by common physical interconnection, signal, and functional characteristics.
invoke	To put into effect or operation.
ipm	<i>Abbrev. for</i> inches per minute. A measurement of the speed of a printer printing in graphics print mode (plotting speed).

italic A slanted type style. *This is an italic type style.*

## L

LF Line Feed.

landscape Printed perpendicular to the paper motion.

LCD *Abbrev. for* Liquid-Crystal Display. The LCD is located on the operator panel. Its purpose is to communicate information to the operator concerning the operating state of the printer.

LED *Abbrev. for* Light Emitting Diode.

lpi *Abbrev. for* lines per inch. A measurement indicating the vertical spacing between successive lines of text. For example, 8 lpi means 8 lines of text for every vertical inch.

lpm *Abbrev. for* lines per minute: A speed measurement indicating the number of lines printed every minute. (lpm usually defines the speed at which text prints.)

## M

monospaced See font, monospaced.

MM Millimeter.

## N

N/A Not available or not applicable.

NACK Negative-Acknowledge reply. A reply from the printer to the host indicating that an exception has occurred. Contrast with acknowledge character.

NAK Negative-Acknowledge character. A transmission control character transmitted by the printer as a negative response to an enquiry from the host.

nibble A unit of storage containing half of a byte, usually four bits.

NLQ *Abbrev. for* Near Letter Quality.

nS Nanosecond (one billionth of a second)

NVFU Direct Access Vertical Format Unit. See *also* DAVFU.

NVRAM *Abbrev. for* NonVolatile Random-Access Memory. A type of RAM in which stored data are not lost when the power is interrupted or turned off. A battery supplies power to NVRAM when the system does not. Unlike ROM (another type of nonvolatile memory), NVRAM is accessible and its contents can be altered.

## O

OCR	<i>Abbrev. for</i> Optical Character Recognition. A process by which a machine can “read” characters printed in a special standardized font. Data are read by a photoelectric optical scanner and recorded on magnetic tape or disk. OCR-A and OCR-B are two widely used OCR fonts.
off-line	An operational state in which the printer cannot accept commands or data from the host computer, but can perform self-tests, form settings, and record configuration changes.
Ohm	A unit of measurement for electrical resistance.
on-line	An operational state in which the printer is under direct control of the host computer. In this state, the printer accepts commands and data sent from the host computer, and acts on them immediately.

## P

parity (check)	Parity checking is the addition of non-data bits to data, resulting in the number of 1 bits being either always even or always odd. Parity is used to detect transmission errors. Parity represents the value in the check digit of the received or transmitted data.
parsing	Parsing is the process of separating a programming statement into basic units that can be translated into machine instructions. A printer can recover from an erroneous code sequence by performing as much of the function as possible or, parsing the valid parameter from the invalid.
PC	Personal Computer.
PCB	<i>Abbrev. for</i> Printed Circuit Board. A PCB is an insulating board on which circuit paths have been printed or etched.
PCBA	<i>Abbrev. for</i> Printed Circuit Board Assembly. A PCBA is a PCB that has all of the electrical and mechanical components (resistors, capacitors, ICs, sockets, etc.) mounted on it.
PGL <sup>®</sup>	Printronix Graphics Language. The software version of the old hardware based IGP that is used in the Printronix PSA line of printers. It provides the same forms and barcode generation capabilities as the IGP.
PI	Paper Instruction: A signal from the host with the same timing and polarity as the data lines.
pica	A name indicating a monospaced font with a pitch of 10 cpi and usually a 12 point height. Pica is used in typography as a unit of measurement equal to 1/6 inch.
pin configuration	Establishes the physical attachment and protocol conversion connections for the host interface.
pitch	The number of text characters printed per horizontal inch. Specified in characters per inch (cpi).



pixel	Derived from picture (PIX) ELe ment. The smallest displayable picture element on a video monitor or printable unit. In printing, a pixel is a dot.
point	A unit of length in printing and typography, used to specify type sizes, heights of font characters, etc. There are 72 points in a vertical inch; thus, one point equals 1/ 72 inch, or approximately 0.0138 inch. Some examples of point sizes are: This is 8 point type. This manual is printed in 10 point type. <b>This is 14 point type.</b>
port	A channel used for receiving data from or transmitting data to one or more external devices.
Postnet	A bar code standard defined by the U. S. Postal Service.
print mode	Synonym for print attribute. Includes character attributes such as italic, underlining, super/subscript, as well as Draft, NLQ, and DP.
proportional	See font, proportional.
protocol	In general, a set of rules governing the exchange of information between computer systems. For printers, a protocol is the coding system used to convey and print characters and graphics. A printer protocol includes character codes, printer function codes, and machine-to- machine communication codes. In this manual, protocol and emulation mean the same thing. See <i>also</i> compatibility and emulation.

## R

RAM	<i>Acronym for</i> Random-Access Memory. Also called “main memory” or “working memory,” this is the active memory of a printer, into which programs are loaded. This memory can be read from or written to at any time-hence the term “random-access.” RAM is also termed “volatile” because whatever is in RAM is lost when power is turned off or interrupted. See <i>also</i> ROM.
read	To retrieve data from memory (RAM, NVRAM) or mass storage (hard disk, floppy diskette, etc.).
reset	To turn off, deactivate, disable, or return to a previously determined state.
resolution	A measure expressing the number of units in a given range used to create an image. In printing, this is expressed as the number of dots per inch (dpi) horizontally and vertically.
ROM	<i>Acronym for</i> Read-Only Memory. Programs, instructions, and routines permanently stored in the printer. ROM is not lost when power is turned off and cannot be written to, hence the term “read-only.” ROM-resident fonts are fonts permanently stored in a printer and available at any time. See <i>also</i> RAM.

roman	A type style in which the characters are upright. This is sentence is printed in a roman type style.
RTS	Request To Send. Control signal from the printer.

## S

sans serif	A typeface or font in which the characters do not have serifs. This font is sans serif.
serial communications	The sequential transmission of data, in which each element is transferred in succession.
serial matrix	A type of printing technology used in some impact printers. Data are sent to the printer through either a serial or a parallel interface, but the print head must receive the data <i>serially</i> in order to form each character. The moving print head uses pins to form whole characters one at a time and one after the other. The pins print dots according to programmed matrix patterns. A <i>line matrix</i> printer also forms characters with dots in matrix patterns, but it feeds print data in parallel to many hammers mounted on a rapidly oscillating shuttle. The hammers fire simultaneously to print entire lines at a time.
serif	A short line stemming from and at an angle to the upper or lower end of the stroke of a letter or number character.



set	To turn on, activate, invoke, or enable.
SFCC	<i>Abbrev. for</i> Special Function Control Character. The first character in a printer command sequence. In Proprinter III XL emulation mode, you can select one of five characters as the SFCC. In Epson emulation mode, the SFCC must always be the ASCII escape character (ESC). <i>See also</i> command sequence <i>and</i> escape sequence.
shadow printing	A typeface with a heavy line thickness produced by doublestriking. The printer forms a character, then prints it again, but fractionally offset from the first position. <i>See also</i> bold, character weight.
shuttle	The subassembly in a line matrix printer that includes the hammer bank assembly, plus some or all of the drive mechanism.
size, type	<i>See</i> point.
slewing	Rapid vertical paper movement.
soft reset	<i>See</i> warm start.
spacing	<i>See</i> font, proportional <i>and</i> font, monospaced.
SSCC	<i>Abbrev. for</i> Super-Set Control Code. It is of the form SFCC   } ; and is used to execute superscript commands.
start bit	The signal that indicates the start of a character or element in a serial data stream.

stop bit	The signal that indicates the end of a character or element in a serial data stream.
string	Two or more bytes of data or code treated as a unit.
style, type	See type style.
superset commands	Commands which are an extension to the base LinePrinter+ printer protocol, such as the bar code commands for the Epson FX protocol. See also SSCC.
symbol set	See character set.

## T

TOF	Top Of Form.
TTL	Transistor-Transistor Logic.
true	On or 1. "High true" refers to a positive relative voltage representing the ON state; "low true" refers to a zero or negative relative voltage representing the ON state.
type family	See typeface.
type size	See point.
type style	Refers to either the upright or italic character style in a specific font family. Roman is upright, <i>italic is slanted</i> .
typeface	A descriptive name or brand name that identifies a particular design of type. Also called type family.
typographic font	See font, proportional.

## U

UPC	Universal Product Code.
-----	-------------------------

## V

VFU	<i>Abbrev. for</i> Vertical Format Unit.
VGL	Code V Graphics Language. An emulation of the QMS Code V Magnum firmware. The software version of the old hardware based IGP that is used in the Printronix PSA line of printers. It provides the same forms and barcode generation capabilities as the IGP.
VT	Vertical Tab.

## W

warm start	A reboot or soft reset. The following occurs: 1) data are cleared from all buffers (I/O and internal print buffers); 2) all internal system variables are reset to default values, which is transparent to the user; and 3) the power-up configuration values-except the host I/O selection-are loaded. If the user has not defined power- up configuration values, the printer resets to the factory default configuration values.
weight	See character weight.
word	1. A storage unit consisting of the number of bits that comprise one storage location in main memory. 2. The name used for a variable or constant in a program. 3. The data value occupying a storage location.
write	To place data in memory (RAM, NVRAM) or in mass storage (hard disk, floppy diskette, etc.).

## X

X-OFF	A character transmitted by the printer announcing that the printer is off-line or the buffer is almost full.
X-ON	A character transmitted by the printer announcing that the printer is on-line or the buffer is almost empty.

# E *Contact Information*

## Printronix Customer Support Center

**IMPORTANT** Please have the following information available prior to calling the Printronix Customer Support Center:

- Model number
- Serial number (located on the back of the printer)
- Installed options (i.e., interface and host type if applicable to the problem)
- Configuration printout: (See "Printing A Configuration" ) in your printers Administrator's manual.
- Is the problem with a new install or an existing printer?
- Description of the problem (be specific)
- Good and bad samples that clearly show the problem (faxing or emailing of these samples may be required)

Americas	(714) 368-2686
Europe, Middle East, and Africa	(31) 24 6489 311
Asia Pacific	(65) 6548 4114
China	(86) 800-999-6836

<http://www.primtronix.com/support.aspx>

## Printronix Supplies Department

Contact the Printronix Supplies Department for genuine Printronix supplies.

Americas	(800) 733-1900
Europe, Middle East, and Africa	(33) 1 46 25 19 07
Asia Pacific	(65) 6548 4100
China	(86) 400-886-5598
India	1800 102 7869

<http://www.primtronix.com/supplies-parts.aspx>

## Corporate Offices

Printronic, LLC.  
6440 Oak Canyon RD, Suite 200  
Irvine, CA 92618  
U.S.A.  
Phone: (714) 368-2300  
Fax: (714) 368-2600

Printronic LLC.  
c/o Printronic Nederland BV  
Bijsterhuizen 11-38  
6546 AS Nijmegen  
The Netherlands  
Phone: (31) 24 6489489  
Fax: (31) 24 6489499

Printronic Schweiz GmbH  
3 Changi Business Park Vista  
#04-05 AkzoNobel House  
Singapore 486051  
Phone: (65) 6548 4100  
Fax: (65) 6548 4111

Printronic Commercial (Shanghai) Co. Ltd.  
Room 903, 9<sup>th</sup> Floor  
No. 199, North Xizang Road  
200070 Shanghai P.R. China  
Phone: (86) 400 886 5598  
Fax: (8621) 61171256

Printronic India Pvt Ltd  
B-808/809, BSEL Tech Park  
8<sup>th</sup> Floor, Sector 30A  
Vashi Navi Mumbai 400705  
India  
Toll Free No.: 1800 102 7896  
Fax: (9122) 4158 5555

Visit the Printronic web site at [www.printronic.com](http://www.printronic.com)